



intuition™
INSTRUMENTS

INTUITION™ INSTRUMENTS SURGICAL TECHNIQUE



Introduction

This surgical technique provides guidelines for the implantation of the ATTUNE® Knee System Family of Knee Implants with the INTUITION™ Instrumentation.

ATTUNE Knee System Implants are available in four configurations:

- Posterior Stabilized Fixed Bearing (PS FB),
- Posterior Stabilized Rotating Platform (PS RP),
- Cruciate Retaining Fixed Bearing (CR FB) and
- Cruciate Retaining Rotating Platform (CR RP)

The Cruciate Retaining (CR) configurations can also be used for Cruciate Sacrificing (CS) applications.

Contents

Key Surgical Steps Summary	2
Incision and Exposure	4
Pinning	5
Pinning Technique	6
Distal Femoral Resection	7
Distal Femoral Resection - Instrument Assembly	8
Distal Femoral Resection	10
Tibial Alignment and Resection - Instrument Assembly	14
Tibial Alignment and Resection	15
Extension Gap Assessment and Balancing	20
Femoral Rotation	22
Measured Femoral Sizing and Rotation	23
Balanced Femoral Sizing and Rotation	29
Femoral Preparation	37
Posterior Condyle Preparation	42
Femoral Resection - PS Femoral Notch Cuts	44
Trial Reduction	46
Soft Tissue Considerations for Cruciate Retaining Application	48
Trial Components	49
Tibial Preparation	53
Patella Resection and Preparation – Instrument Assembly	55
Patella Resection	57
Patella Preparation	59
Lug Hole Preparation	62
Tibial Base Implantation	63
Femoral Component Implantation	65
Tibial Insert Implantation	68
Final Patella Preparation	70
Patella Component Implantation	71
Closure	72
Appendix 1: Optional Patella Drilling Technique	73
Appendix 2: Optional Minimally Invasive Instrument Technique	74
Appendix 3: Optional Lamina Spreader Technique	78
Appendix 4: ATTUNE Tibial Insert Trials and Trial Handle	81
Appendix 5: Revision Fixed Bearing (FB) Tibial Base	82
Appendix 6: Optional Balancing Block Technique	92
Flexion/Extension Gap Chart	102
Tibial Component Sizing Chart	103
Compatibility Data	104
Symbols on Surgical Instruments	105

Key Surgical Steps Summary

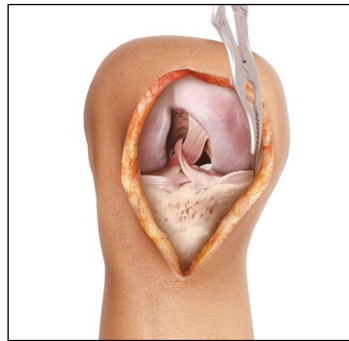

Incision and Exposure

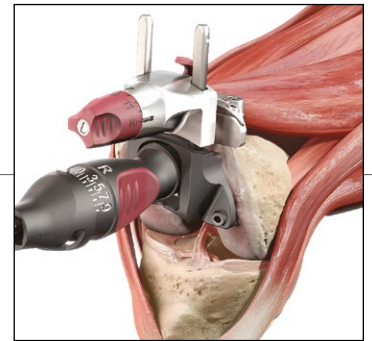

Femoral Alignment and Distal Resection

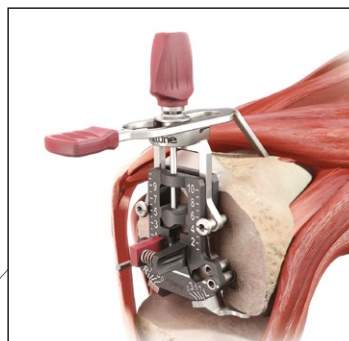

Measured Femoral Sizing and Rotation



Femoral Preparation

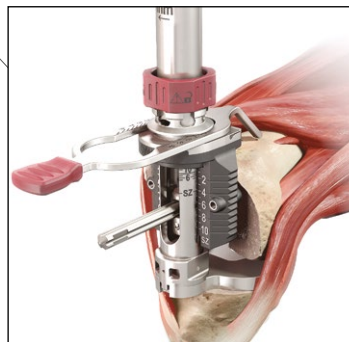

Balanced Femoral Sizing and Rotation



Femoral Lug Hole Preparation



Patella Resection and Final Patella Preparation



Tibial Alignment and Proximal Resection



Extension Gap Assessment and Balancing



Trial Reduction



Tibial Preparation



Final Component Implantation

Note: All resections are done using a 1.19 mm Saw Blade to maximize accuracy through the Slotted Cutting Guides.

Incision and Exposure

The INTUITION Instruments are designed for both standard open and minimally invasive approaches to the knee.

Incision and exposure should be performed using the surgeon's preferred technique.



INFORMATION

Excise any hypertrophic synovium and a portion of the infrapatellar fat pad to allow access to the medial, lateral, and intercondylar spaces.

Before proceeding, consider removing prominent osteophytes, particularly medial and lateral osteophytes, as they can affect soft tissue balancing.

Accurate patella alignment is important for proper placement and tracking. It is recommended not to drill the patella lug holes prior to the trialing step so that correct rotation and position of the patella trial may be assessed.

Many of the instruments on the following pages are made of polymer materials. As with any composite or polymer-based instrument, it is important to allow adequate drying time after cleaning.

Pinning

The ATTUNE Knee System has 3.15 mm diameter pins to increase the stability and functionality of the instruments. The INTUITION Instruments are designed to be used with the ATTUNE Pinning System that contains Universal Pins and Threaded Headed Pins. Threaded Non-Headed Pins are also shown below.



Universal Pin

The Universal Pin can be drilled in or hammered in, and drilled out or pulled out using the Pin Jack.



Threaded Headed Pin

The Threaded Headed Pin is designed to be inserted and removed with a Power Drill. These pins are best used to secure blocks against a flat surface such as cut bone.



Threaded Non-Headed Pin

The Threaded Non-Headed Pin is also available and is designed to be inserted and removed with a Power Drill.



Pin Jack



Power Driver

i INFORMATION

Steinmann Pins are compatible with all pin holes throughout the INTUITION Instruments.

It is recommended to use Threaded Headed Pins through the divergent holes in the A/P Chamfer Block to provide sufficient stability against the distal femoral cut.

Pinning Technique



Correct Pinning



Incorrect Pinning

Do not overtighten.
Overtightening may change the angle or cause the pin to strip.



Headed Pins are best used to secure blocks against a flat surface such as cut bone. Non-Headed Pins are recommended for use with cutting blocks against a curved surface such as with the Distal Cut Block.

Distal Femoral Resection

If the Balanced Sizer is intended to be used, then the position of the IM hole is important as it determines the Pivot point for femoral rotation. It should be selected to be 3 - 5 mm medial to the apex of the intercondylar notch and 7 - 10 mm anterior to the origin of the Posterior Cruciate Ligament (PCL).

Drawing a centering mark or Whiteside's Line and the pre-operative X-ray may be useful to assist precise location of the IM hole.

In the proper position, the Step Drill should pass easily into the femoral canal.

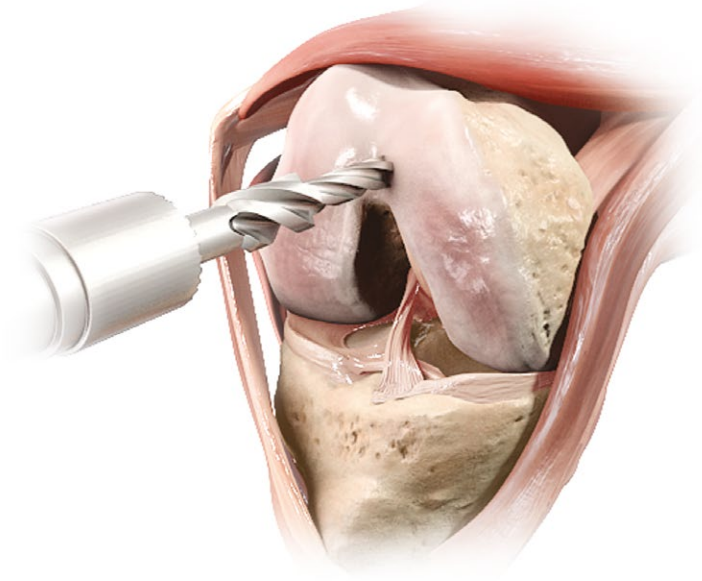

Use the step feature of the Step Drill to increase the diameter of the hole. This will allow depressurization of the canal when the IM Rod is inserted. 



CAUTION

If using the Balancing Block technique, described in Appendix 6, ensure that you do not use the stepped portion of the Step Drill.

Distal Femoral Resection – Instrument Assembly

Distal Femoral Jig Assembly

Order of Assembly:

1. Rotate the Resection Knob of the Outrigger counterclockwise until the padlock symbol is aligned with the arrow.
2. Insert the Outrigger Slide into the Outrigger.
3. Rotate the Resection Knob clockwise to set the desired resection level.
4. Engage the Distal Femoral Cutting Block with the Outrigger Slide and the Cutting Block Clip.

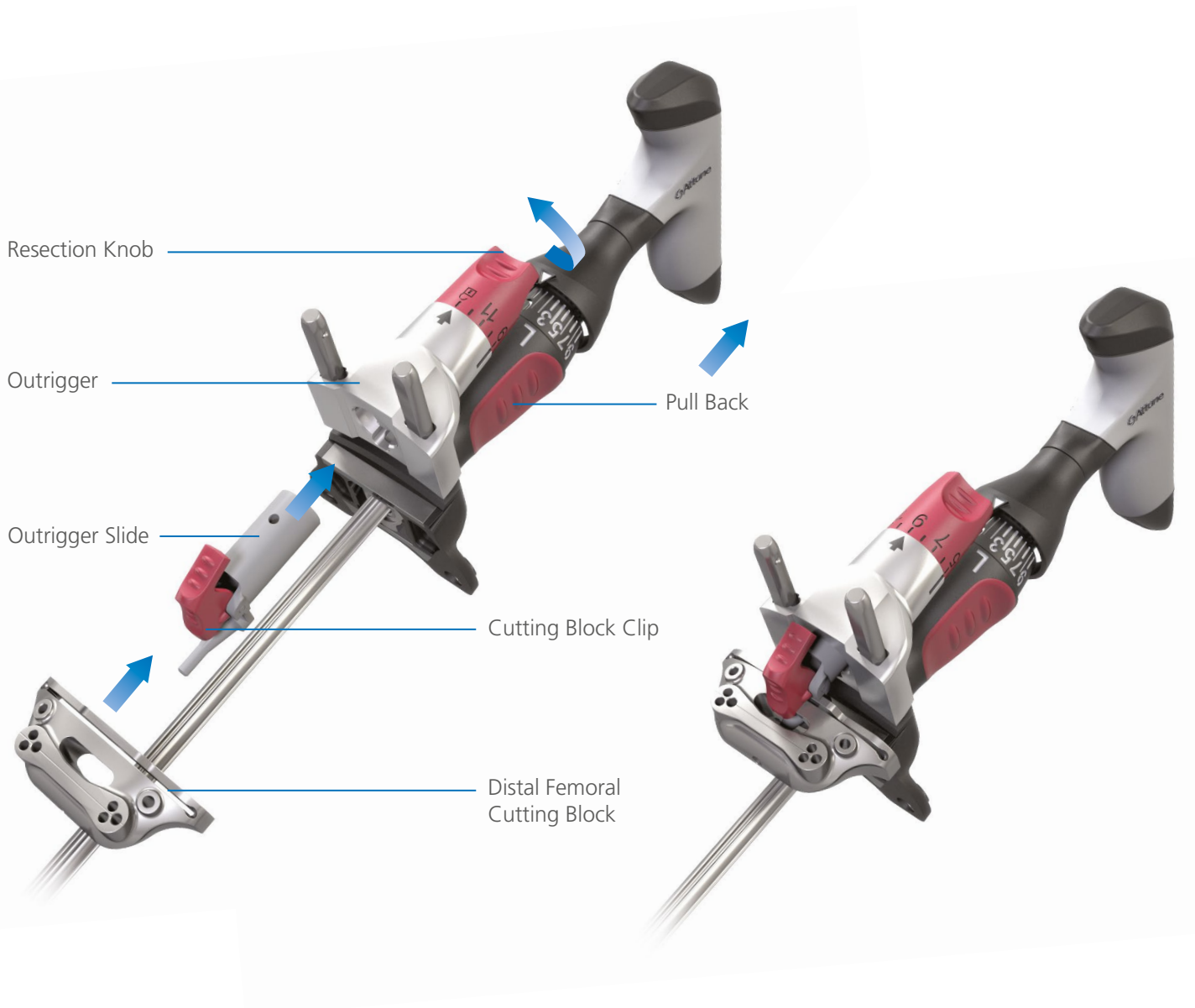

Distal Femoral Resection – Instrument Assembly

A 9 mm resection will match the thickness of the implant. The arrow on the Outrigger, near the Resection Knob, indicates the resection level when using the Cutting Slot. Each click moves the Distal Femoral Cutting Block 1 mm proximal or distal.

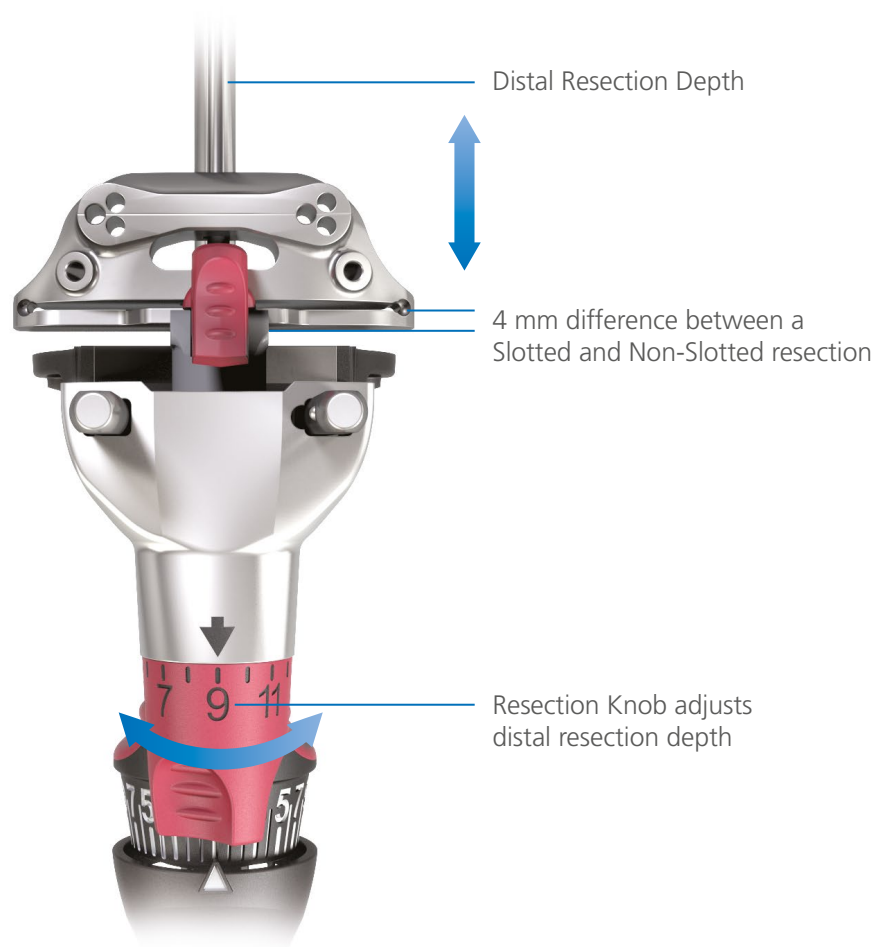

Distal Femoral Resection

Set the desired Valgus angle (left or right - 0 degrees to 9 degrees) on the Distal Femoral Jig by pulling the Varus/Valgus (V/V) Dial toward the Femoral Handle, rotating it clockwise or counterclockwise to the appropriate setting.

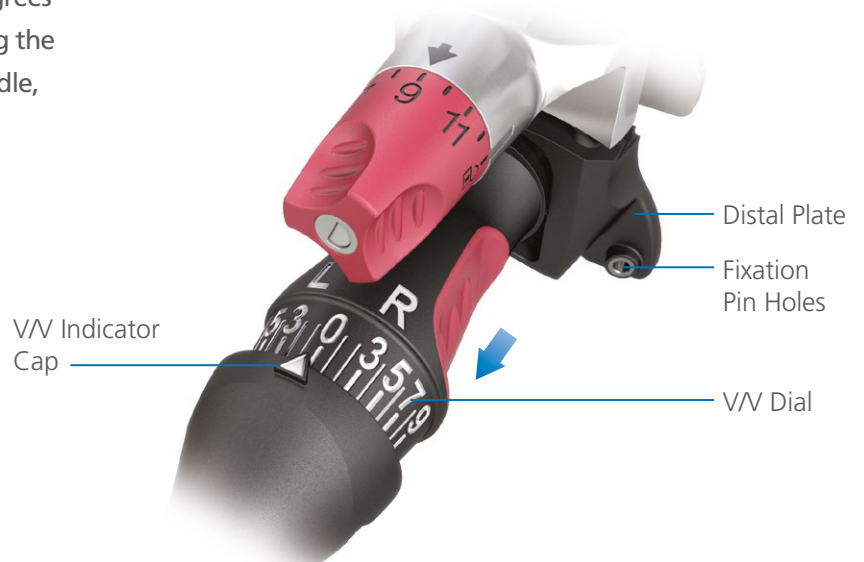

INFORMATION

Be sure that the Varus/Valgus Dial is FULLY disengaged by sliding it back from the Distal Plate before rotating it.

Distal Femoral Resection

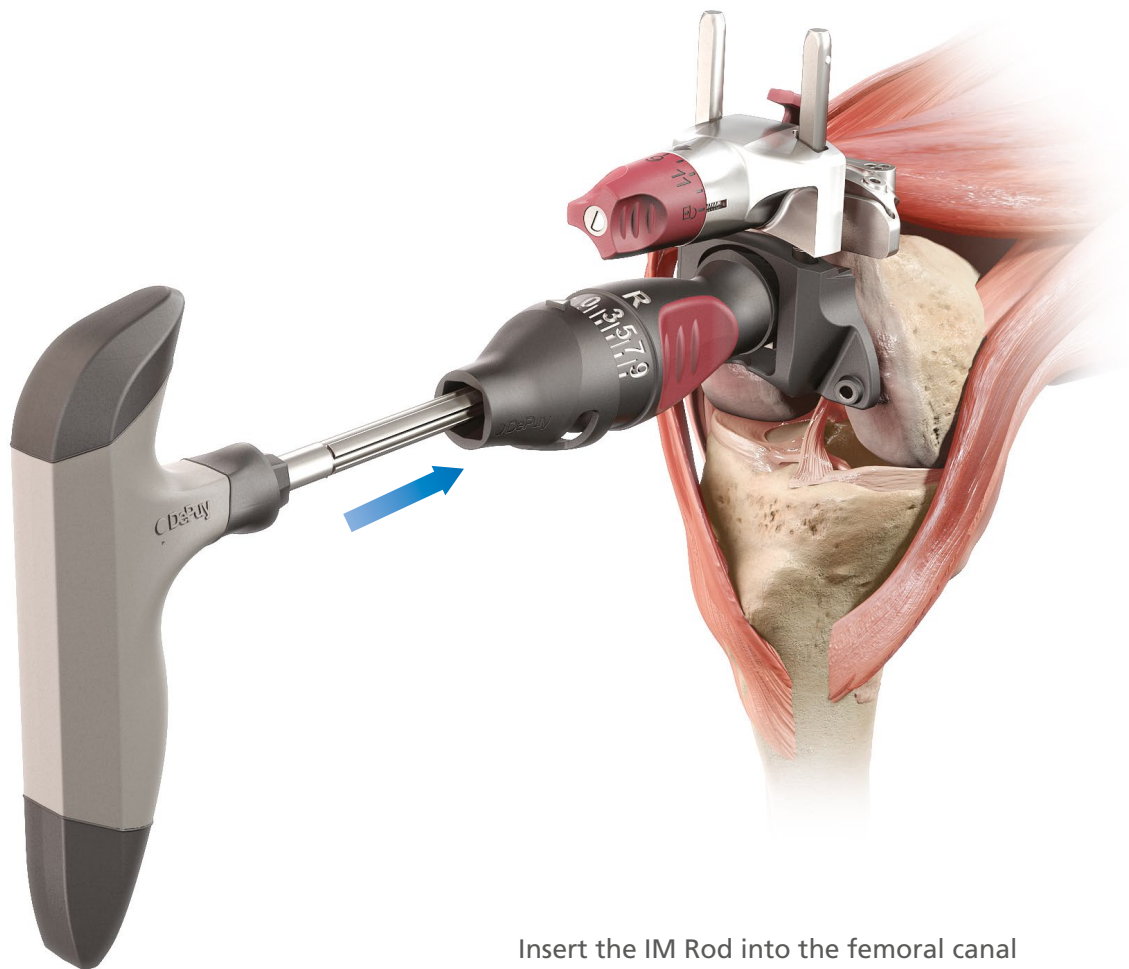

Insert the IM Rod into the femoral canal to the level of the isthmus. Disengage the Distal Femoral Jig from the Handle by pushing on the V/V Indicator Cap and slide the Jig toward the femur until the distal plate contacts the distal femur. The Jig may be pinned temporarily using pin holes in the distal resection plate.

Position the Distal Femoral Cutting Block on the anterior femur by rotating it until it is seated on the anterior condyles.

Distal Femoral Resection

Secure the Cutting Block to the femur with two Universal or Non-Headed Pins through the holes marked with a center line. If necessary for additional stability, insert a Universal or Non-Headed Pin through one of the divergent pin holes on the Cutting Block.

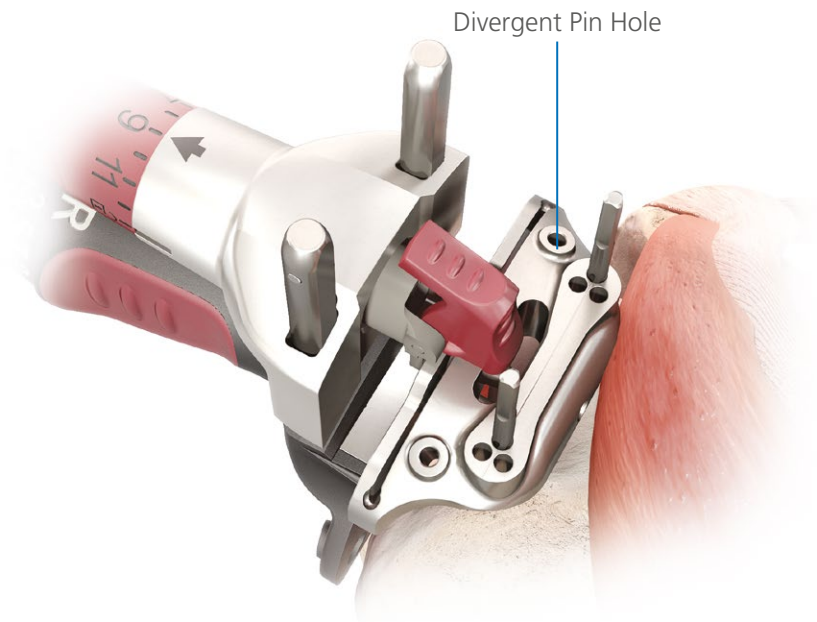

Removal of the Distal Femoral Jig

Disengage the Distal Femoral Cutting Block from the Outrigger Slide by pressing the Red Cutting Block Clip. Pull the entire instrument distally.

To further adjust the distal resection depth once the Distal Femoral Jig is removed, use the distal or proximal pin holes, that move the block 2 mm in either direction.

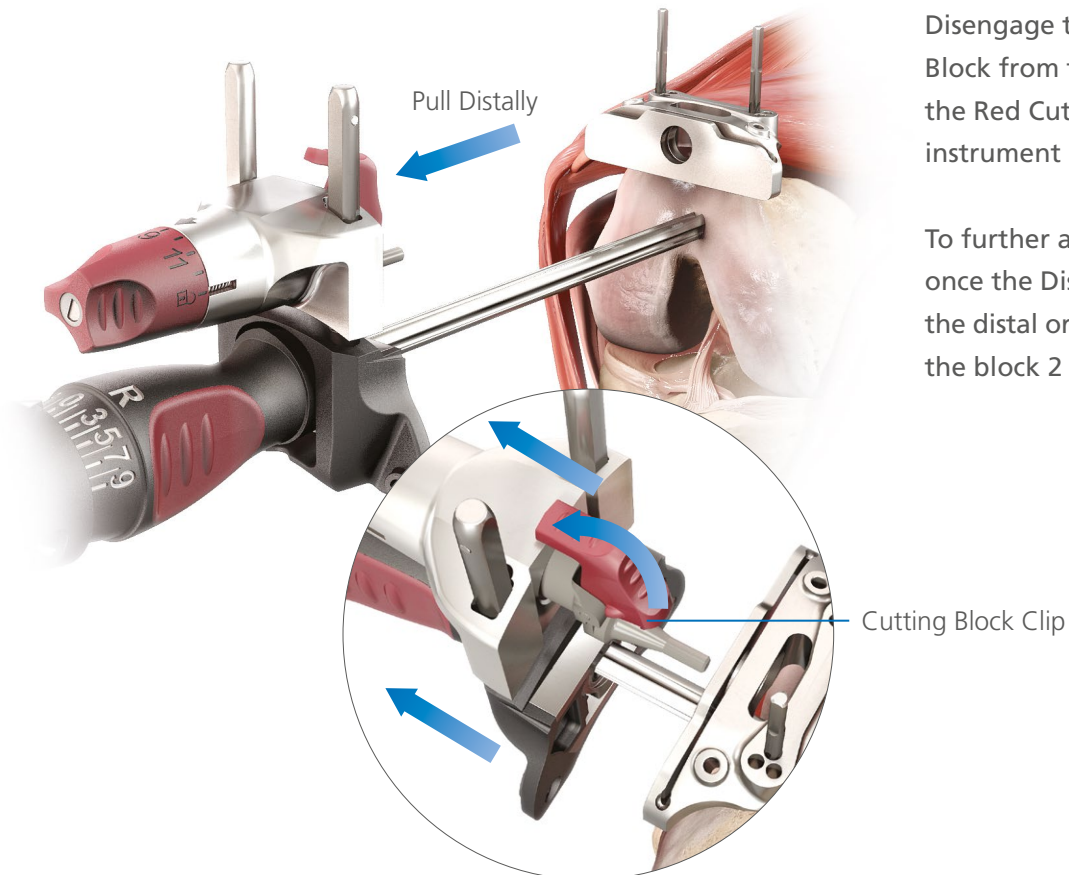

Distal Femoral Resection

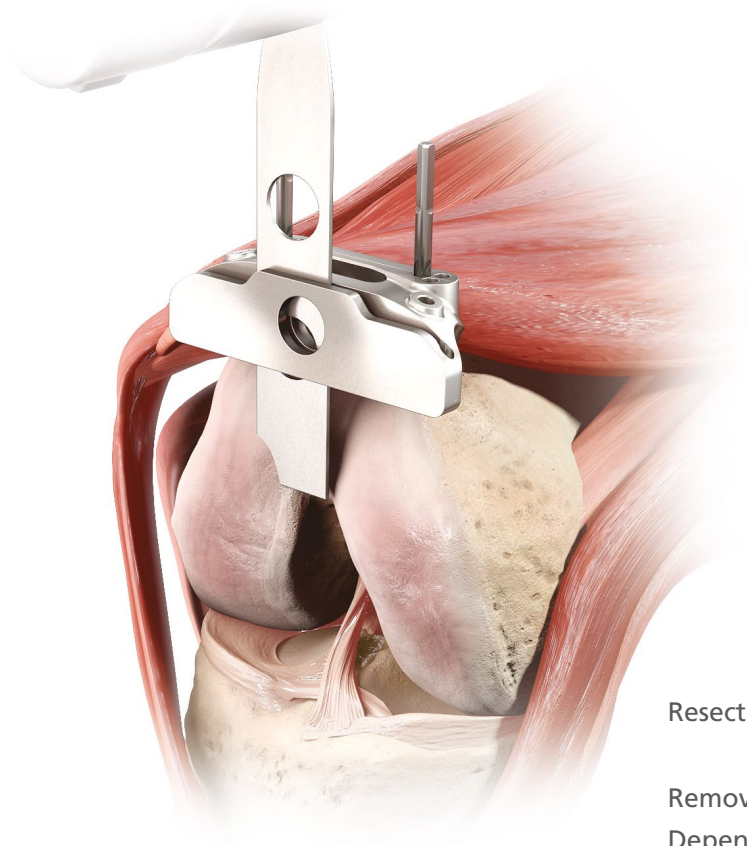

Resect the distal femur.

Remove the Distal Femoral Cutting Block. Depending on surgeon preference, the Pins may be removed or left in place to allow for a recut if required.

Tibial Alignment and Resection – Instrument Assembly

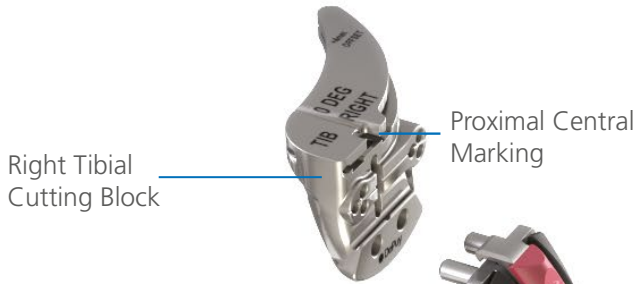

Tibial Jig Assembly

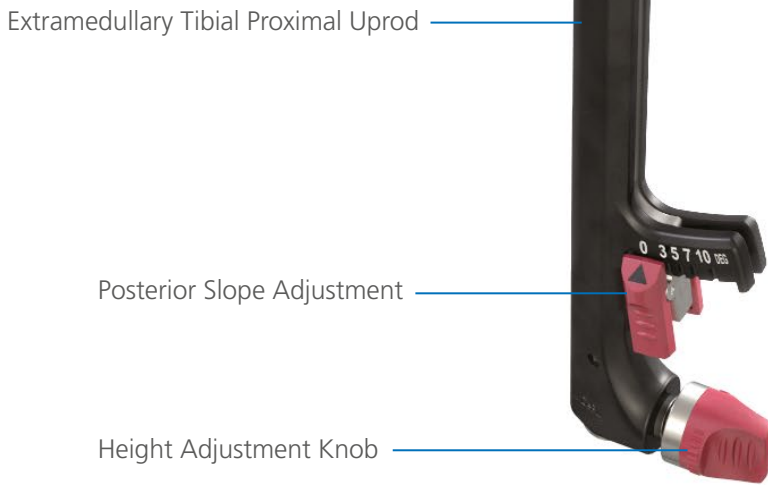

With the Height Adjustment Knob fully unscrewed on the Tibial Proximal Uprod, attach the Tibial Distal Uprod to the Proximal Uprod. Then attach the Tibial Ankle Clamp to the Distal Uprod. Assemble the appropriate Cutting Block to the Tibial Proximal Uprod.

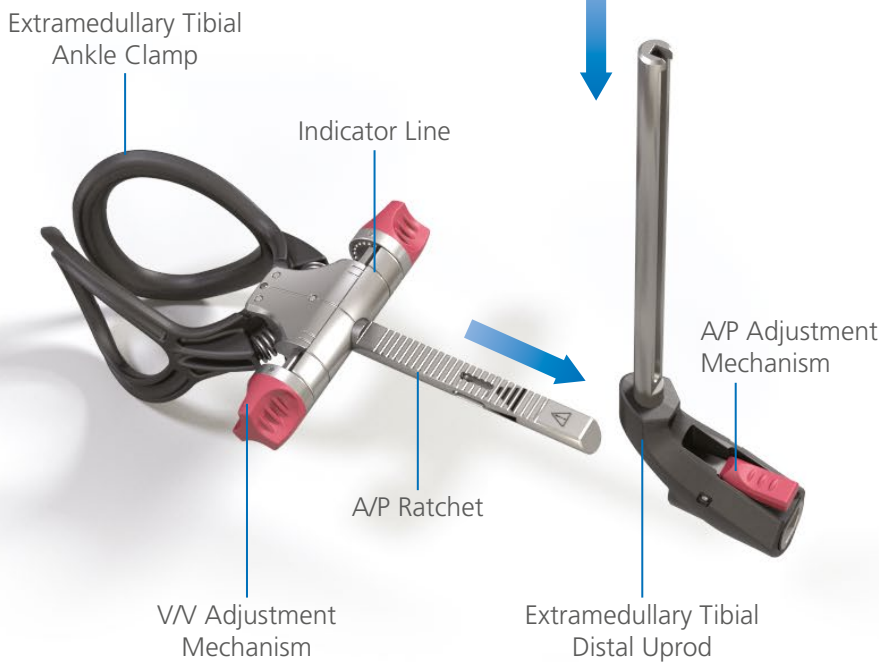

Cutting Block Options



Left Tibial Cutting Block



Right Tibial Cutting Block



Symmetrical Cutting Block

Tibial Alignment and Resection



Pinch Lever

Set the tibial posterior slope as depicted on the Proximal Uprod of the Tibial Jig, according to the recommendations depending on the appropriate implant configuration.

Place the knee in 90 degrees of flexion. Place the Ankle Clamp around the malleoli. Set Varus/Valgus rotation by aligning the proximal central marking on the Tibial Cutting Block with the medial one third of the tibial tubercle.

The axis of the Proximal Uprod should be positioned with reference to the tibial axis.

Note that the figures on the Jig will only deliver that angle if the rest of the Jig is set up correctly as pictured here. If the slope adjustment is changed after the Cutting Block is resting against bone, the surgeon should re-align the Uprod to be parallel to the tibial axis by moving the A/P adjustment mechanism.



i INFORMATION

Tibia Slope Recommendations: For a Posterior Stabilized (PS) configuration it is recommended to set the tibial posterior slope at 3 degrees. For a Cruciate Retaining or Cruciate Sacrificing (CR/CS) configuration, a range of 5 - 7 degrees of tibial posterior slope is recommended, attempting to match the patient's slope. In PCL-retaining TKA not adding adequate slope may limit the post-operative flexion.

Tibial Alignment and Resection

When checking and setting the sagittal alignment, be careful to prevent anterior slope. This could happen if the A/P Boss on the Distal Uprod is translated too far towards the ankle, exposing the Through-Slot. Posterior slope adjustment is the equivalent to using Cutting Blocks with slope built into them.

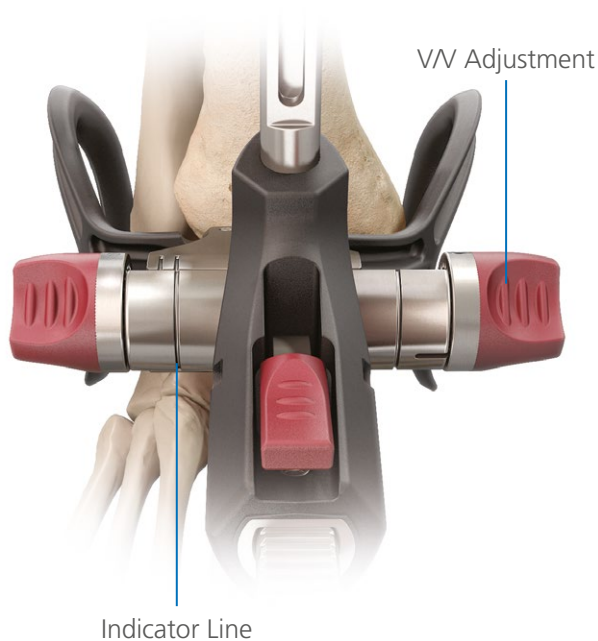
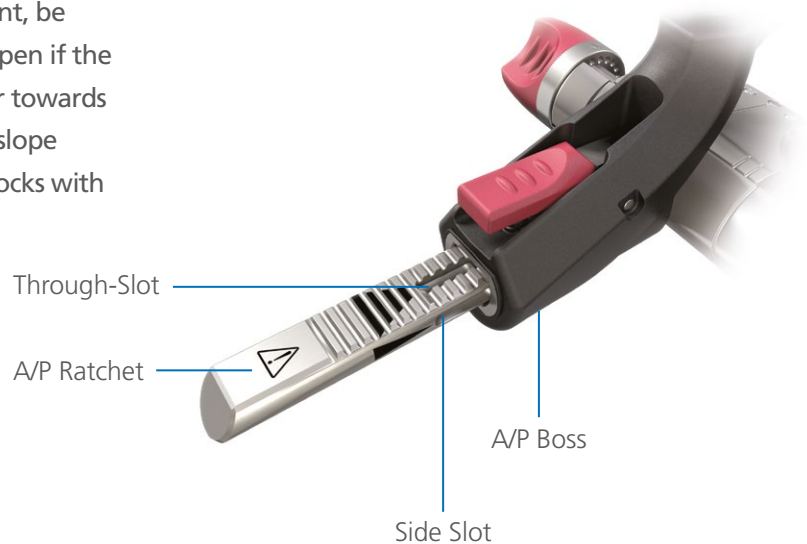

Use the Varus/Valgus Adjustment Mechanism to align the Tibial Proximal Uprod parallel to the long axis of the tibia. For many patients, this involves translating the V/V Adjustment Mechanism until the second line from the lateral side of the ankle clamp lines up with the indicator line.

i INFORMATION

In ankles with a large soft tissue envelope in which the soft tissue prevents achieving 0 degrees of alignment at the neutral position, the Distal Uprod can be moved posterior to reveal the Through-Slot to achieve a 0 degree slope.

Tibial Alignment and Resection

Stylus Attachment

Attach the Adjustable Tibial Stylus to the Cutting Block through the slot feature.

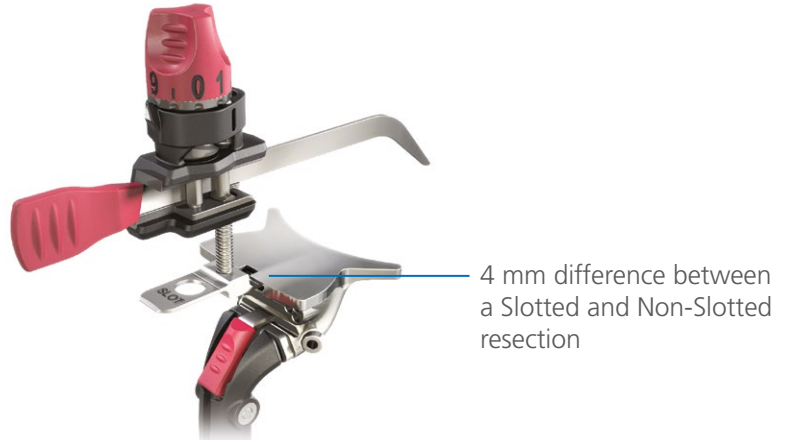
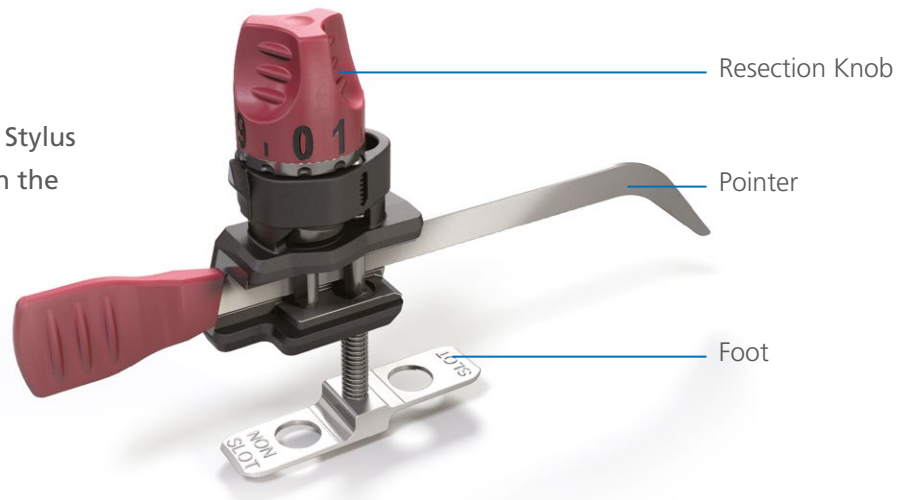

Resection through the Slot

If planning to resect through the slot, position the foot of the Stylus marked "slot" into the Slot Feature of the Cutting Block.

Resection on top of the Cutting Slot

If planning to resect on top of the Cutting Block, place the foot marked "non-slot" into the Slot Feature.

i INFORMATION

The minimum composite thickness of the tibial implant (4 mm base + 5 mm insert) is 9 mm.

Rotate the Resection Knob to set the resection level on the Stylus (0 to 10). Each number corresponds to a resection amount in millimeters.

Rest the pointer of the Adjustable Tibial Stylus on the lowest point of the tibial plateau. Then lock the Height Adjustment Knob on the Proximal Uprod.

Tibial Alignment and Resection

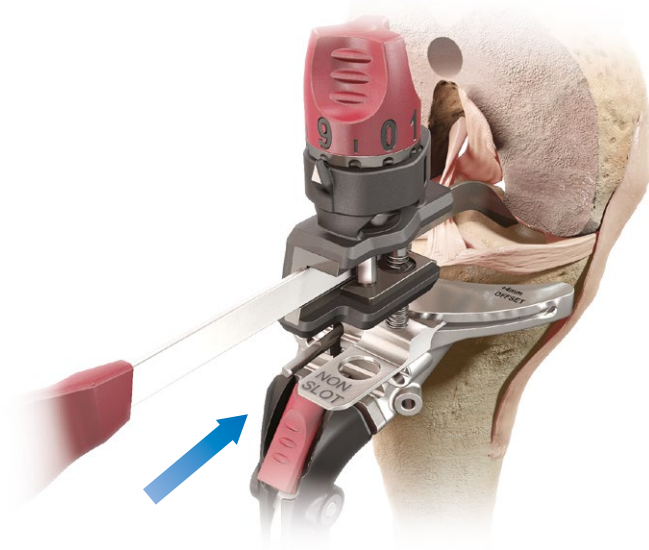

After the height has been set, pin the block through the holes marked by a center line using two Universal Pins.

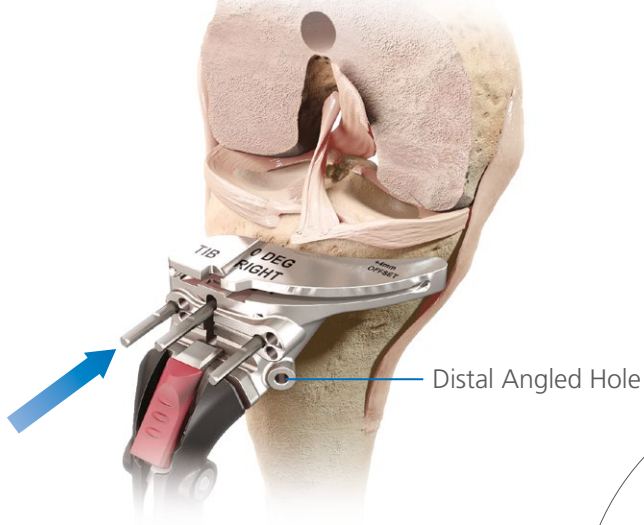

If necessary, remove the Stylus for better access, ensuring that the Height Adjustment Knob is locked. The resection level can be adjusted by using the distal or proximal pin holes, which move the block 2 mm in either direction. If desired, the Cutting Block can be more securely fixed with an additional Universal or Non-Headed Pin placed through the distal angled hole.

Temporary Fixation Pin Slot

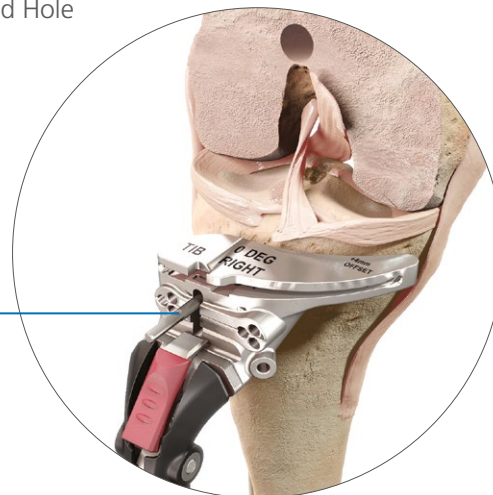

Tibial Alignment and Resection



Optional: To assess tibial slope prior to performing the tibial resection, place the Alignment Handle into the slot feature of the Tibial Cutting Block, and insert the Alignment Rod. Alignment can be checked by ensuring that the Alignment Rod remains parallel with the tibial axis. A second Alignment Rod may be inserted through the Alignment Handle in the M/L plane to help ensure that the tibia is not cut in Varus or Valgus.

Additionally, the two Alignment Rods may be assembled with the Alignment Handle to assess long leg alignment from hip center to ankle.

Resect the tibia.



INFORMATION

Place retractors to protect the PCL and collateral ligaments during tibial resection if a CR implant is chosen.

Extension Gap Assessment and Balancing



Posterior Stabilized

For the PS technique, connect the ATTUNE Knee System Spacer Base and desired Shim to the Spacer Block to assess both the extension and flexion gaps. When the ATTUNE Knee Spacer Base is attached, both ends of the Spacer Block are equal thickness and can each be connected to a different Shim to allow successive evaluation of multiple thicknesses. As an example, if the surgeon is unsure as to whether the gap will correspond to a 5 mm or 6 mm insert, the 5 mm Shim can be connected to one end and the 6 mm Shim to the other.

Cruciate Retaining

For the CR technique, evaluate the CR extension gap as described in the previous paragraph. To assess the CR flexion gap connect the CR Flexion Base and desired Shim to one end of the Spacer Block. The CR Flexion Base compensates for the 1 mm difference in thickness of the posterior condyles of the CR implant.

	PS	CR
Distal Condyle Thickness	9	9
Posterior Condyle Thickness	9	8



INFORMATION

The Spacer Block is designed to accommodate both CR and PS techniques. In the PS implant the distal and posterior condyles are the same thickness, resulting in no compensation required for extension and flexion balancing. In the CR implant the posterior condyle is 1 mm thinner than the distal condyles. The Spacer Block connects to Shims on both ends to evaluate multiple

thicknesses. The labels on the Shims indicate the thickness of the insert they represent when assembled to the Spacer Block, and can be read off the top of the Shim when it is attached to the Spacer Block. Although any size Shim will assemble to the Spacer Block, the size 5/6 Shim is recommended as it most closely matches the shape of the Spacer Block.

Extension Gap Assessment and Balancing

To check the extension gap, fully extend the leg and place the appropriate end of the Spacer Block between the two resected surfaces. The Block should fit snugly in the extension space. The extension gap should be rectangular with the leg in full extension. If the extension gap is not balanced, adjust the angle of either the tibial or the femoral cut, or perform appropriate soft-tissue releases to achieve balance.

If desired, perform a gentle Varus/Valgus stress test with the Spacer Block in place. Typically 1 mm to 3 mm of opening both medially and laterally is desirable.

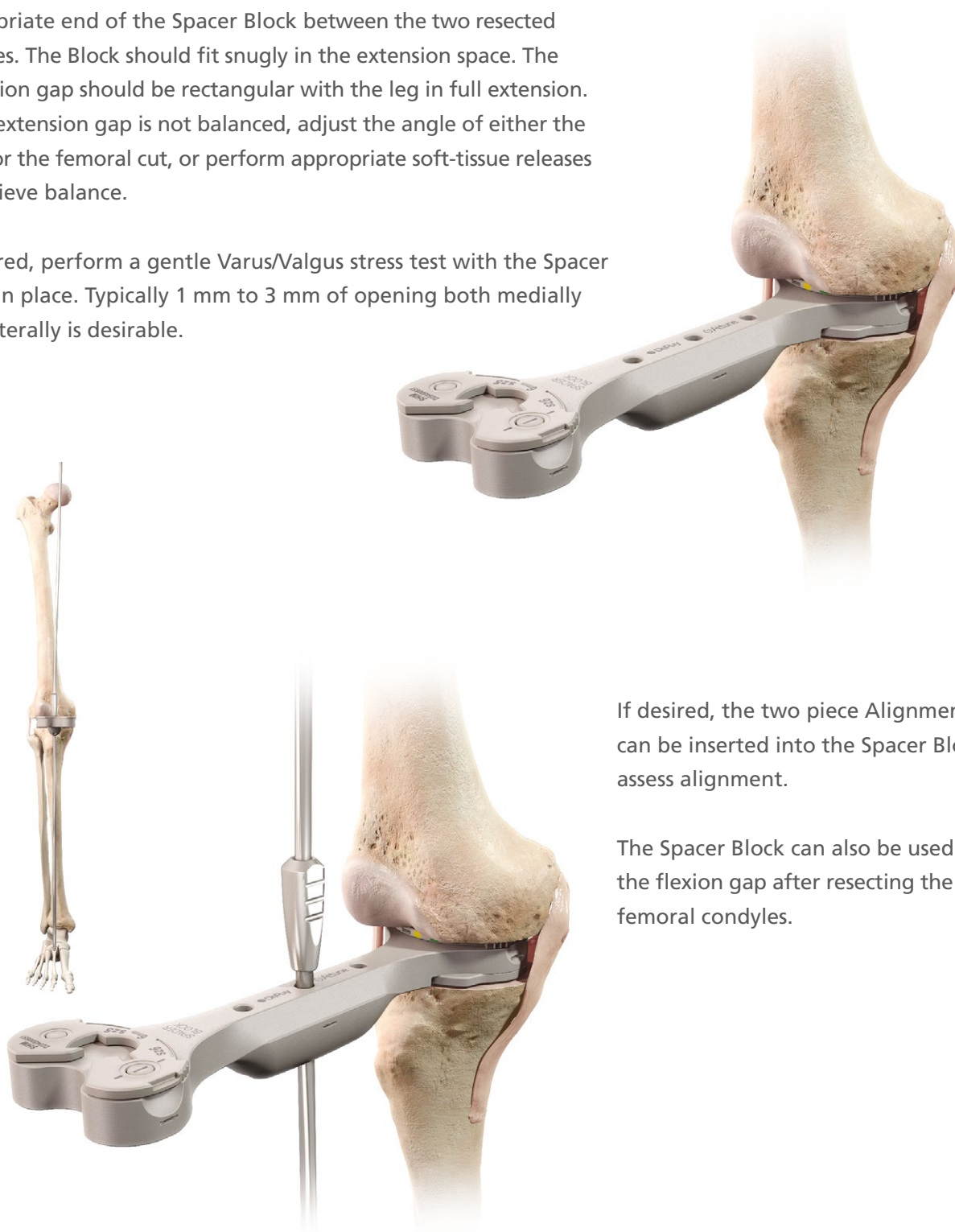

If desired, the two piece Alignment Rod can be inserted into the Spacer Block to assess alignment.

The Spacer Block can also be used to assess the flexion gap after resecting the posterior femoral condyles.

Femoral Rotation

There are multiple ways of setting the femoral rotation, such as the Measured Sizer or Balanced Sizer

Balanced and appropriate external rotation of the femoral component is important for tibiofemoral stability in flexion and patello-femoral tracking/function.

Depending on the surgeon's preference, rotation may be set with reference to either key anatomical landmarks via the measured resection approach, or by balancing the soft tissues in flexion with the goal of generating a rectangular flexion gap. A secondary check to key anatomical landmarks should also be made to avoid malrotation of the femoral component.

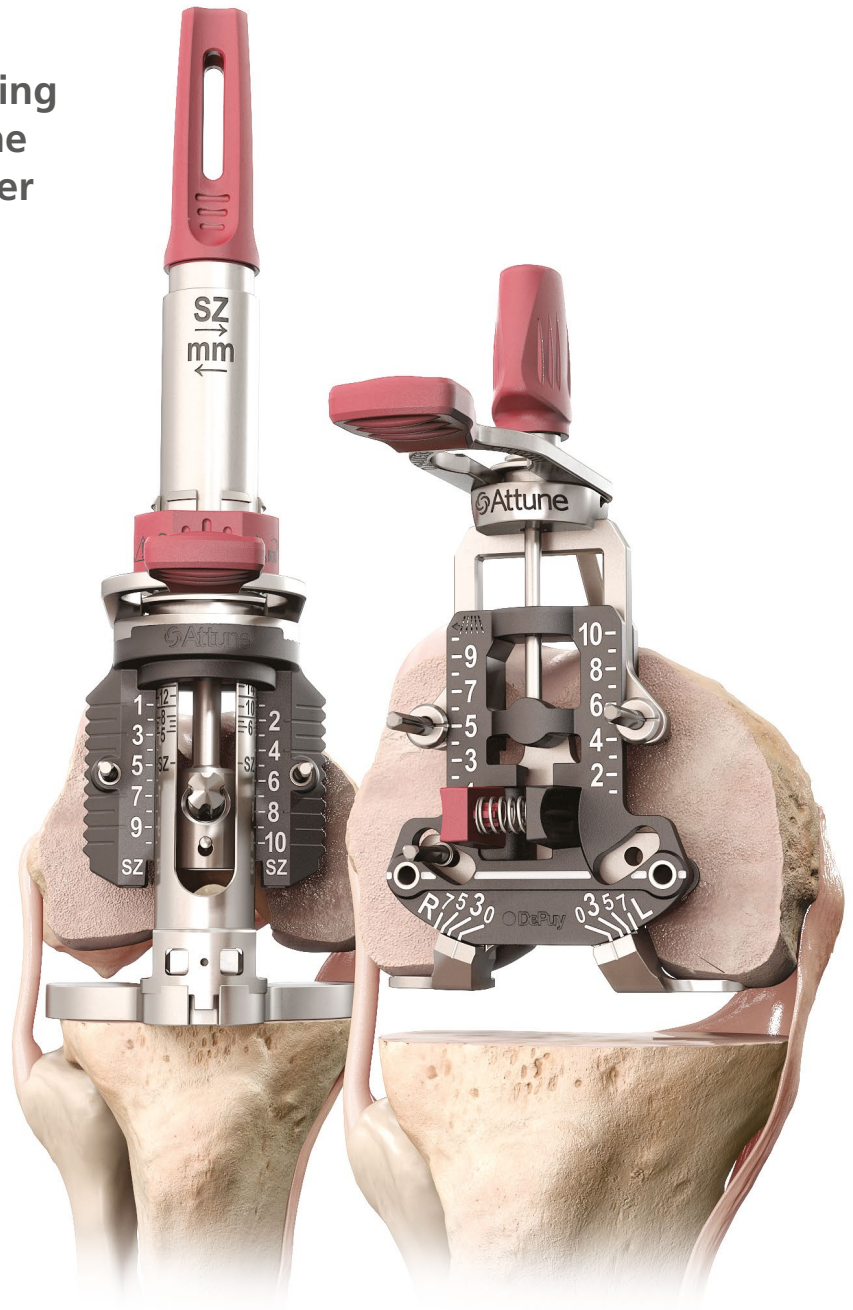

Balanced Sizer

Measured Sizer



INFORMATION

Proper soft tissue balance is important for successful Knee Replacement. It is especially important in a Rotating Platform (RP) knee construct to reduce the risk of spin out of the tibial insert.

Measured Femoral Sizing and Rotation

Measured Sizing and Rotation Guide

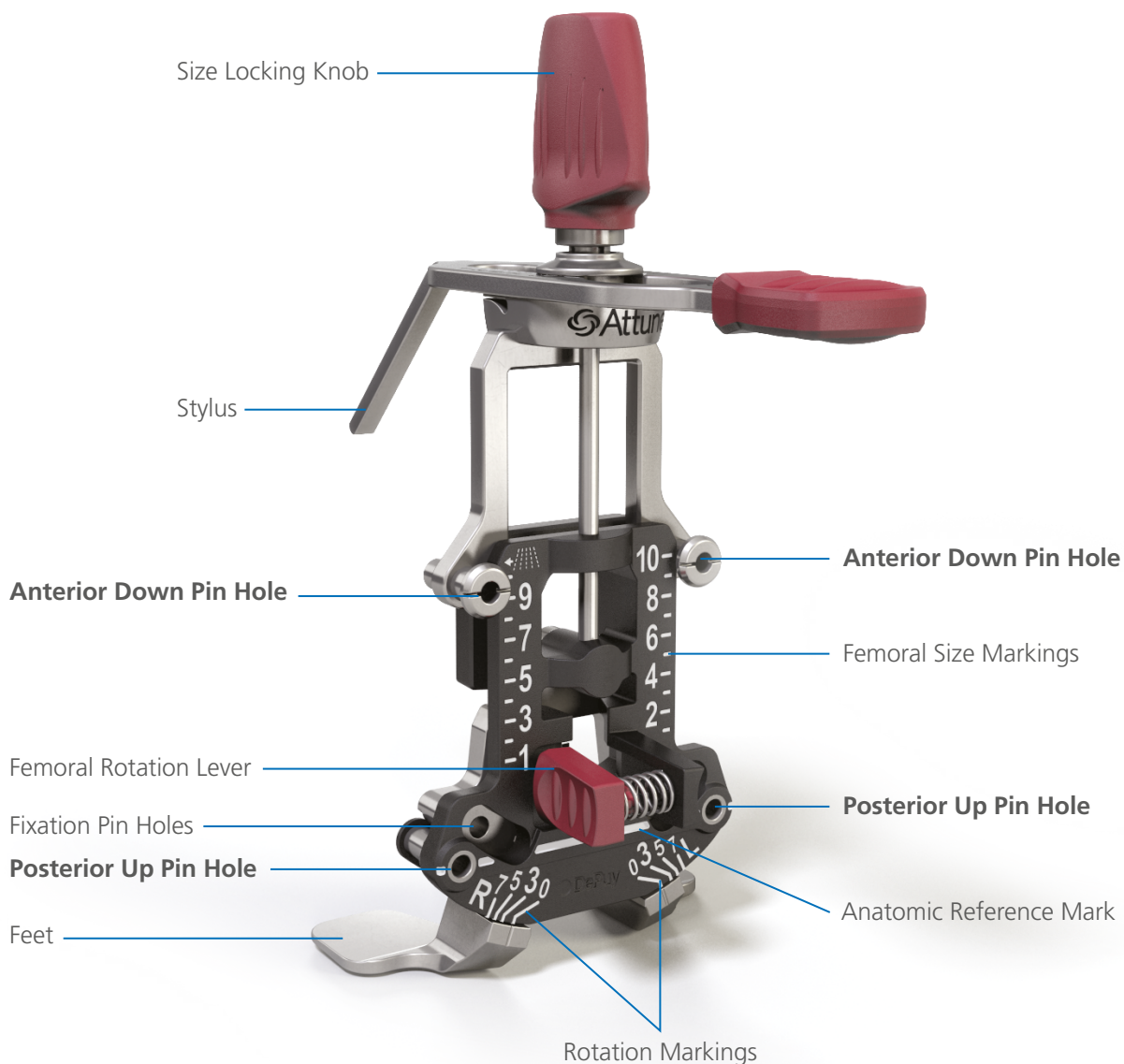

INFORMATION

Choosing the anterior down pin holes will provide a fixed anterior reference with a constant anterior cut, regardless of the size of the A/P Chamfer Block. All variability in bone cuts from size to size will occur on the posterior cut.

Conversely, choosing the posterior up pin holes will provide a fixed posterior reference with a fixed posterior cut. All variability in bone cuts from size to size will occur on the anterior cut.

The Measured Sizer instrument is named to indicate its use for a Measured Resection surgical philosophy and is not a measurement device.

Measured Femoral Sizing and Rotation

Placement of Sizing Guide

Mark the A/P Axis (Whiteside's line) and/or the transepicondylar axis on the resected distal femur.

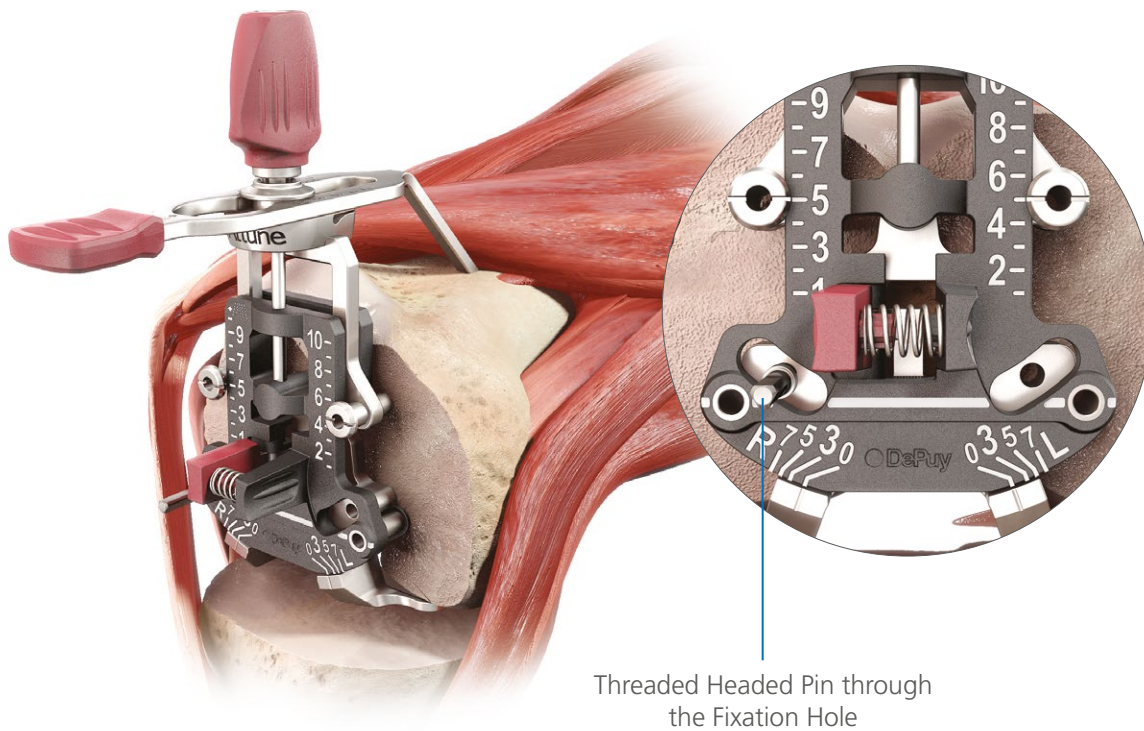
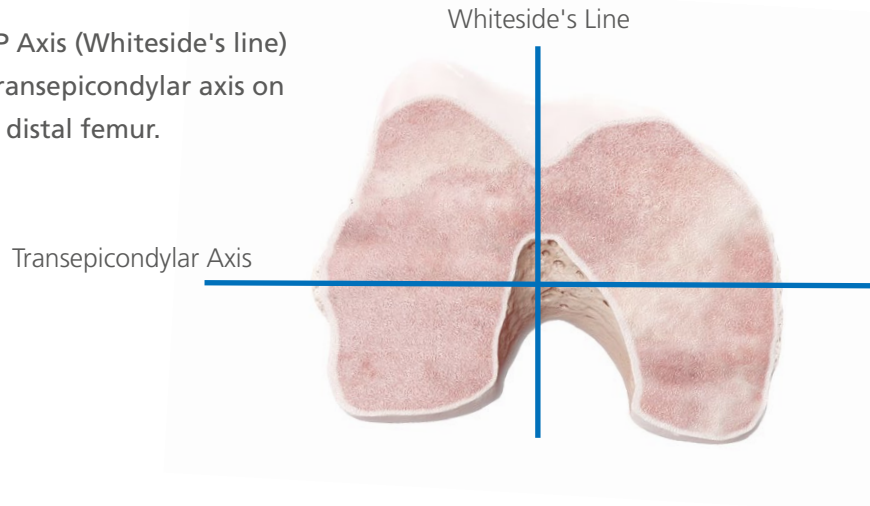

Place the Measured Sizing and Rotation Guide against the resected surface of the distal femur with the posterior feet of the Guide contacting the posterior condyles. If desired, secure the Guide with a Threaded Headed Pin through the fixation hole.

Measured Femoral Sizing and Rotation

Setting Rotation

Squeeze the Lever and simultaneously rotate

Adjust the degree of external rotation to be parallel to the transepicondylar axis and perpendicular to Whiteside's line by squeezing the Femoral Rotation Lever and rotating the anterior section while holding the feet of the device against the posterior condyles.

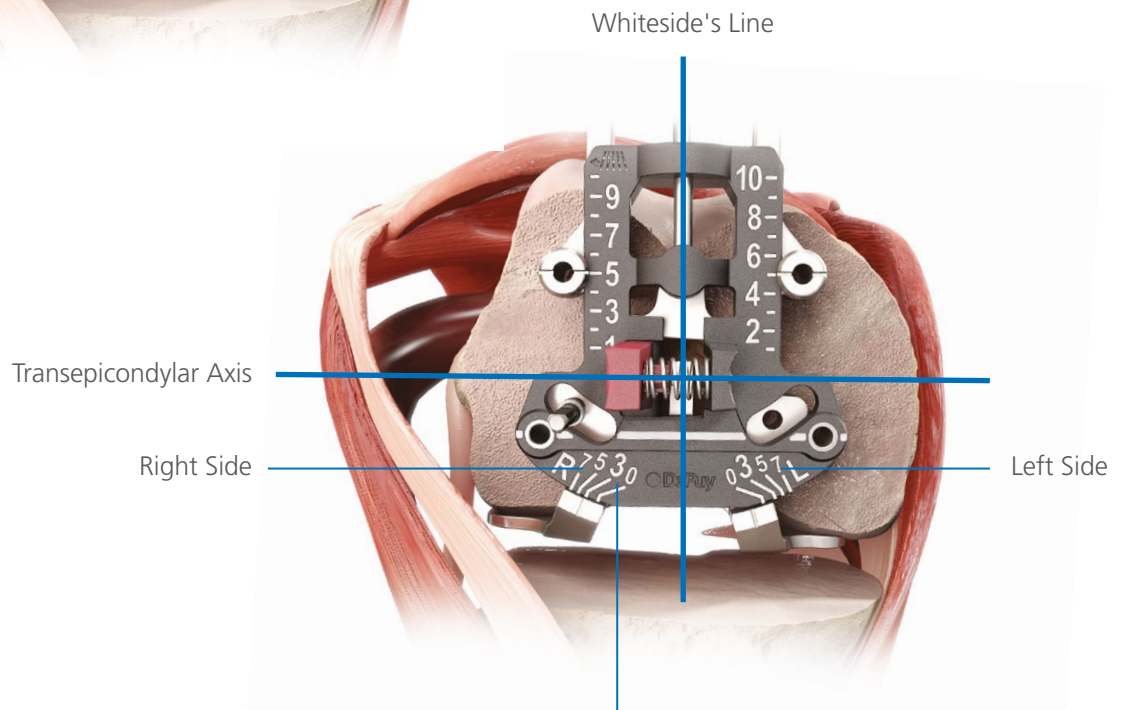
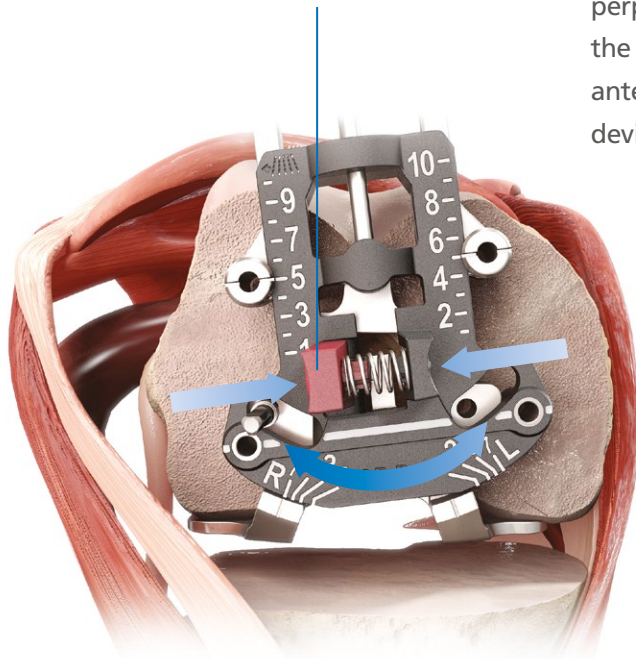

The rotation markings indicate the degree of external femoral rotation with reference to the posterior condyles

Measured Femoral Sizing and Rotation

Size Locking Knob

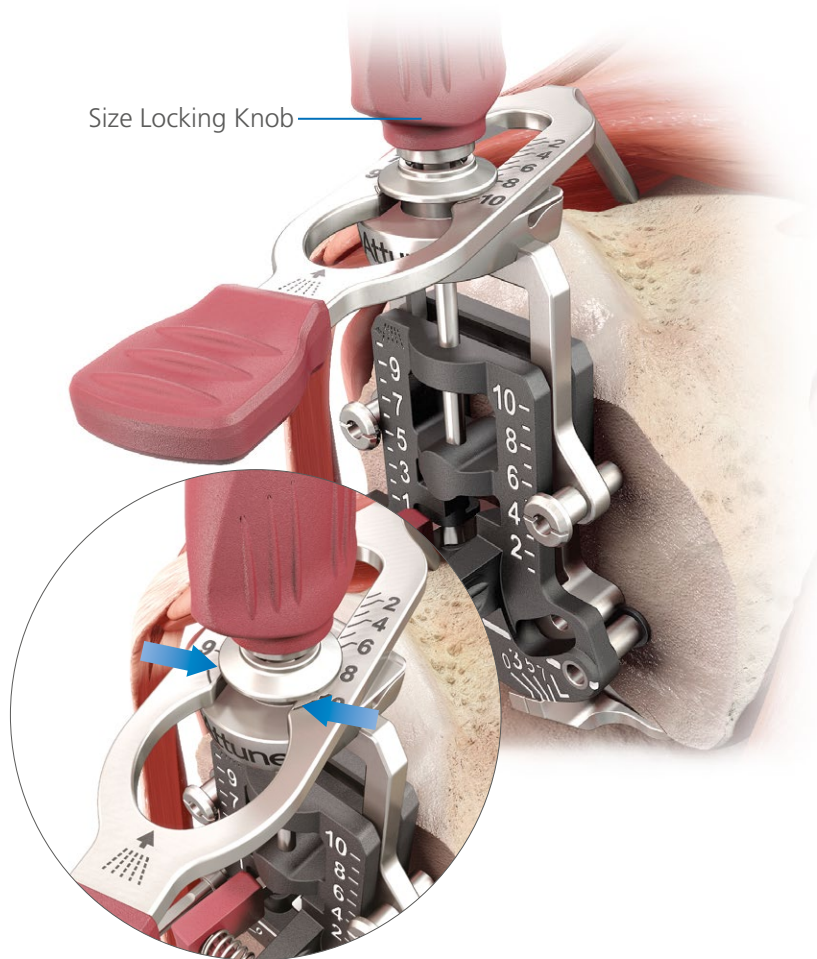

Slide the anterior section down.

Adjust the superior-inferior position of the Stylus to indicate the proper femoral component size. The position of the Stylus will have an effect on the femoral component sizing. Pick the M/L position of the Stylus to match the highest point of the anterior femur at the appropriate size indication on the Stylus scale. The position of the Stylus will then be located near the exit point of the Saw Blade.

Read the scale from the distal side of the Size Locking Knob.

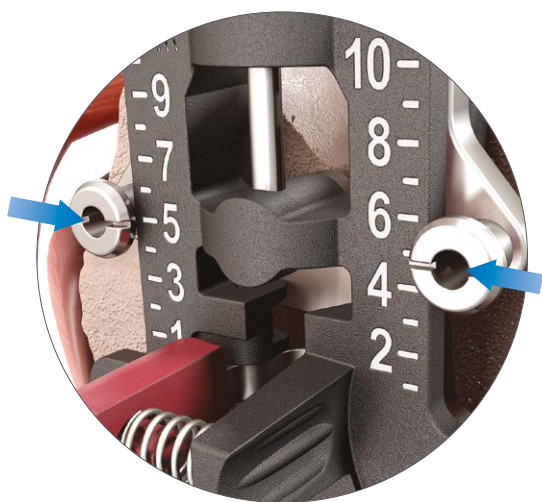

The line through the center of the Anterior Down Pin Holes indicates the size of the femur. Lock the size position by twisting the Size Locking Knob.

Anterior Down Pin Holes indicating Size 5



CAUTION

Be very careful not to apply a large force when contacting the anterior femur with the Stylus, avoiding excessive deflection of the Stylus which may bias the sizing.

Measured Femoral Sizing and Rotation

Pin Insertion

Insert Universal or Non-Headed Pins through the top pin holes for **anterior down** referencing

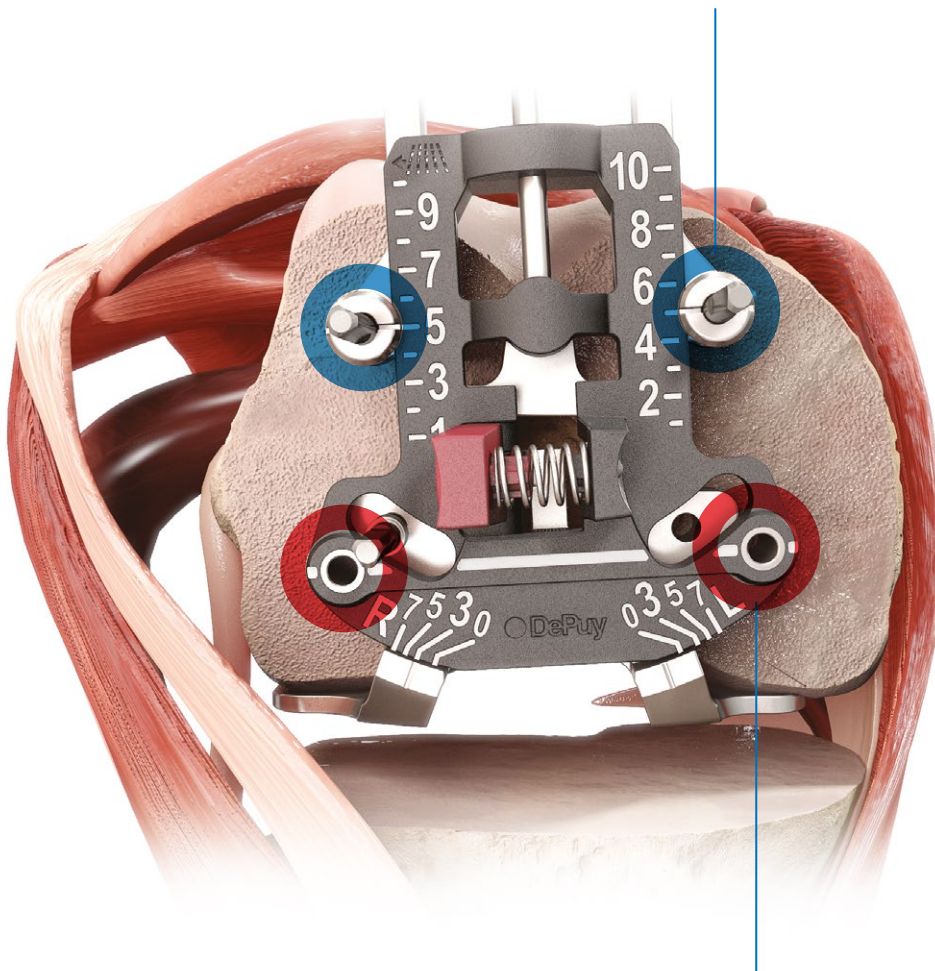

OR

Insert Universal or Non-Headed Pins through the bottom pin holes for **posterior up** referencing

(For further information see page 23).

Measured Femoral Sizing and Rotation

Removal of Sizer

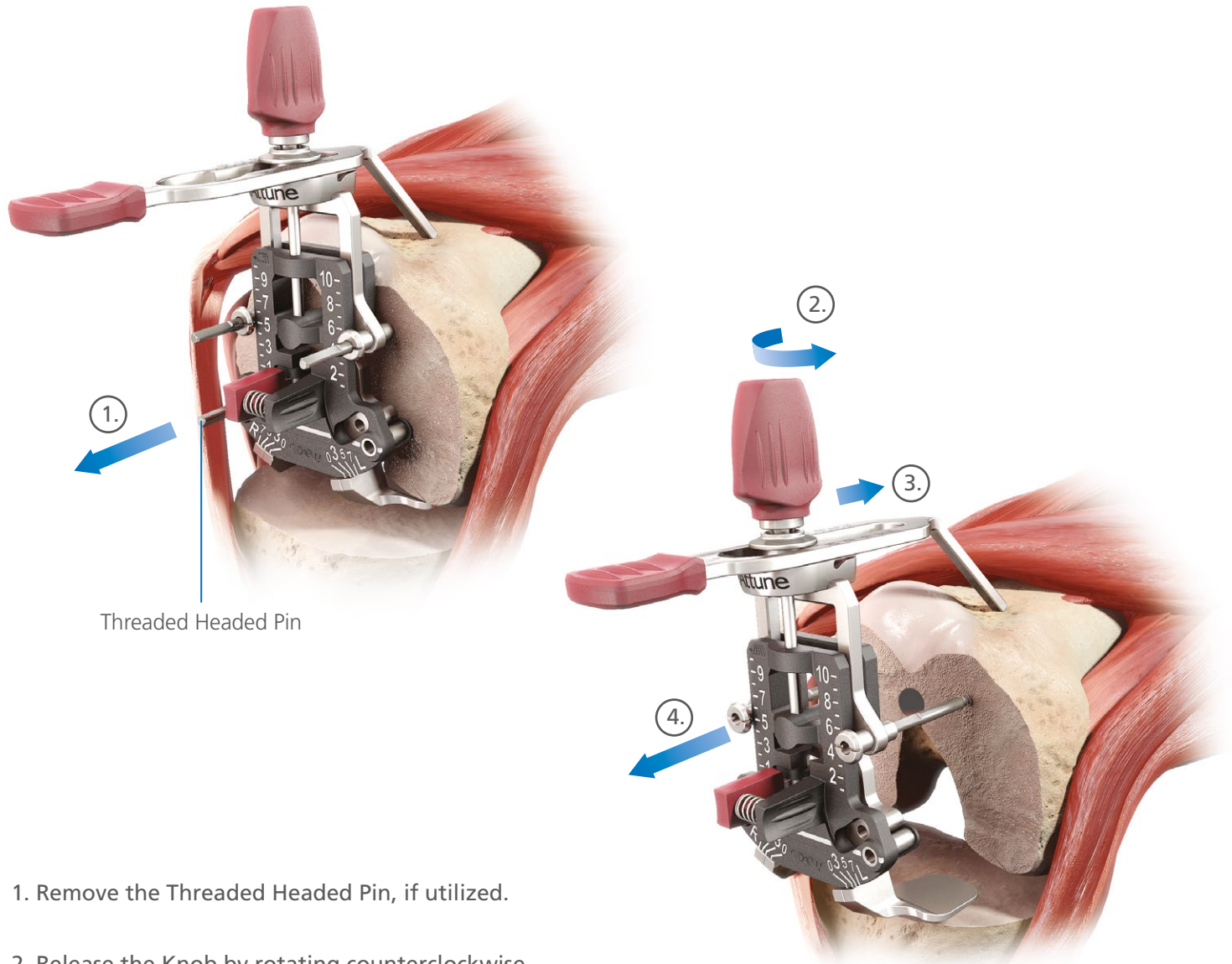

1. Remove the Threaded Headed Pin, if utilized.
2. Release the Knob by rotating counterclockwise.
3. The Stylus is loosened, then pushed forward on the anterior face of the femur so that it is no longer contacting the bone surface (as the anterior surface slopes downward). The Sizer is pulled off the femur and the two components removed together.
4. Remove the Sizing/Rotation Guide, leaving the Universal or Non-Headed Pins in the distal femur.

Balanced Femoral Sizing and Rotation

Balanced Sizing/Rotation Guide Assembly

To accommodate differences in the flexion gap assessment between the CR and PS Femoral Implants, two different feet are available. Attach the appropriate CR or PS Balanced Sizer Foot to the Balanced Sizing/Rotation Guide.

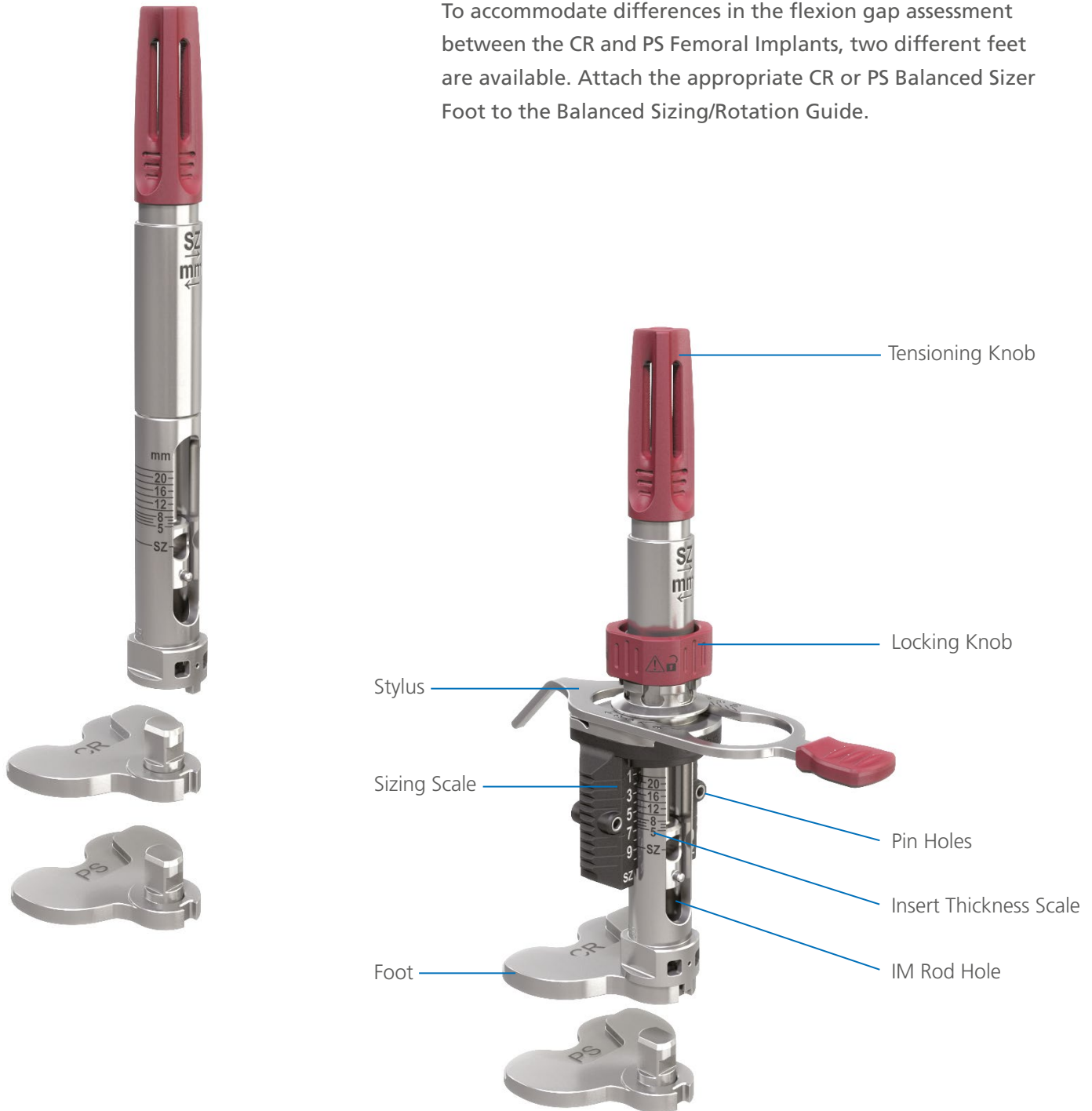

Balanced Femoral Sizing and Rotation

Balanced Sizing and Rotation Guide

The Balanced Sizer performs several key functions:

1. Sizes the femur
2. Sets rotation of the femoral component based on ligament tension
3. Enables assessment of the flexion gap in comparison to the previously determined extension gap

Before using the Balanced Sizer, clear osteophytes to remove any impingement of soft tissues especially in the posterior capsule. Evaluate the extension gap using the Spacer Block. After making the primary cuts and determining the extension gap, record the insert thickness that corresponds to the extension gap for future reference.

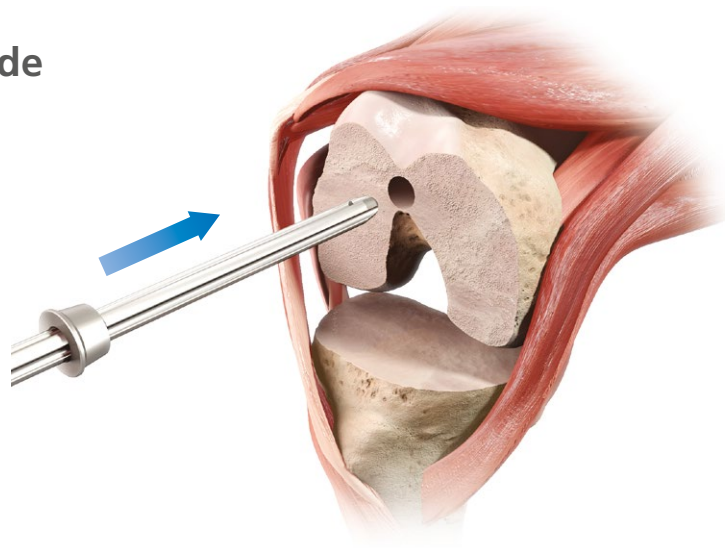

Attach the IM Rod Handle to the Balanced Sizer IM Rod and insert the Rod into the intramedullary canal.

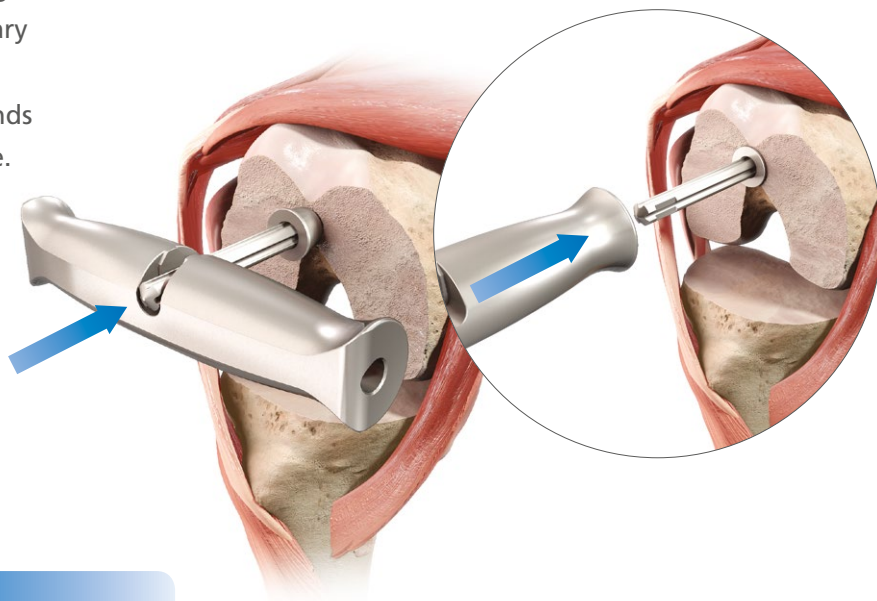

Use the handle as a Slap Hammer to secure the Tapered Plug and stabilize the IM Rod.



INFORMATION

The Balanced Sizer technique is anterior referencing only. The Tapered Plug may not fit flush against the bone, but should be tight.

The IM Rod should not be inserted past the isthmus to ensure that the angle of the rod is not affected.

Ensure that the IM canal has been prepared up to the wider diameter of the Step Drill.

Balanced Femoral Sizing and Rotation

Sizing the Femur

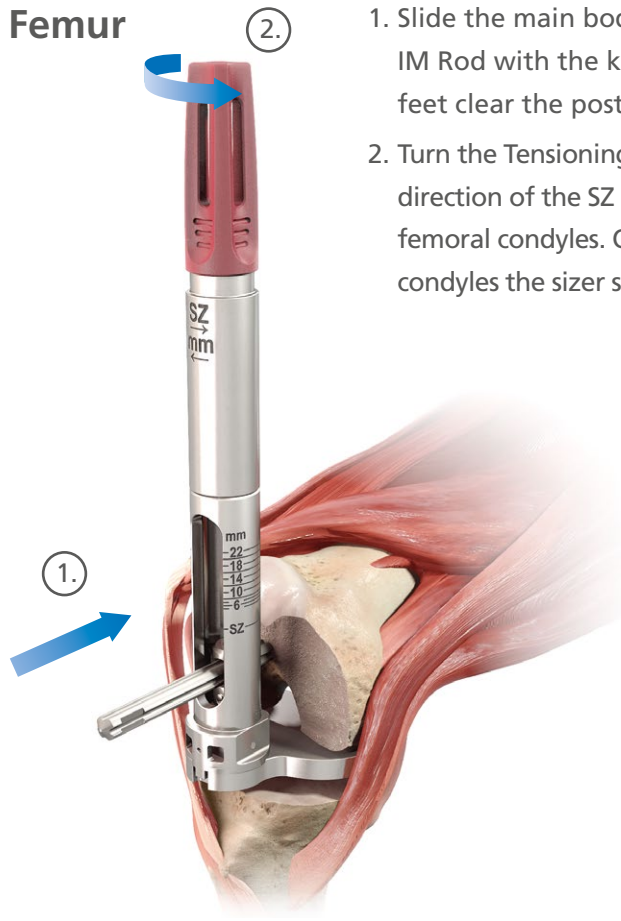

1. Slide the main body and foot of the Balanced Sizer onto the IM Rod with the knee flexed at 90 degrees, ensuring that the feet clear the posterior condyles.
2. Turn the Tensioning Knob in a counterclockwise direction (in the direction of the SZ arrow) until the Foot contacts the posterior femoral condyles. Once the Foot contacts the posterior femoral condyles the sizer should not be able to rotate about the IM Rod.

Slide the Sizing Guide and Stylus over the main body of the Balanced Sizer until the Stylus touches the anterior femur.

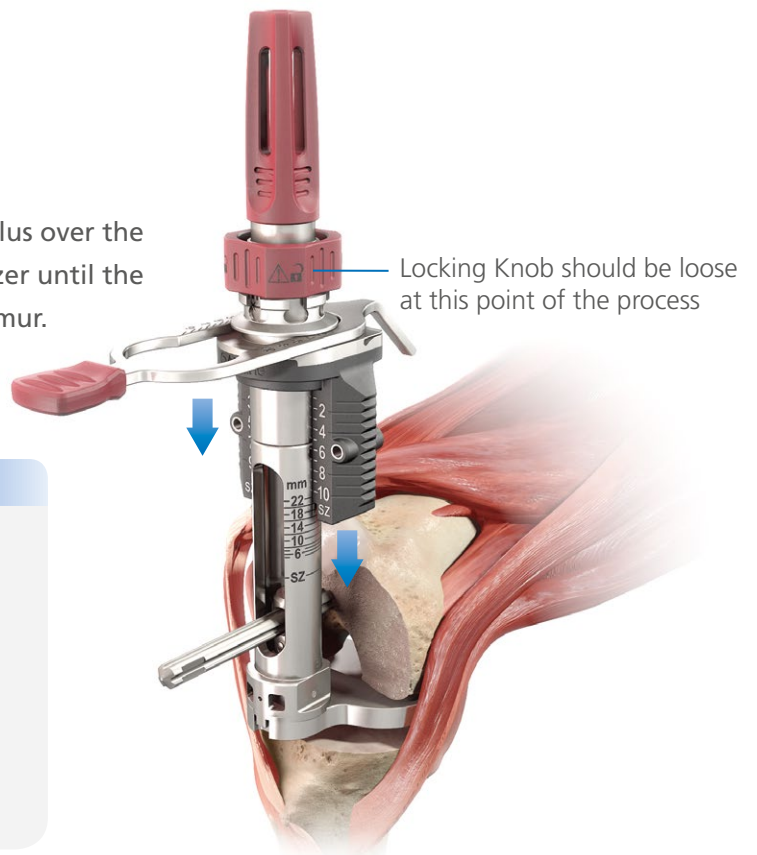

i INFORMATION

Once the Foot of the Balanced Sizer has contacted the posterior femoral condyles, be careful not to excessively rotate the Tensioning Knob in the direction of the SZ arrow as this could result in disassembling the device.

Balanced Femoral Sizing and Rotation

Confirm that the Guide is firmly placed against the distal femoral cut with the knee flexed at 90 degrees.

Adjust the superior-inferior position of the Stylus to indicate the proper femoral component size. The position of the Stylus will have an effect on the femoral component sizing. Pick the M/L position of the Stylus to match the highest point of the anterior femur at the appropriate size indication on the Stylus scale. The position of the Stylus will then be located near the exit point of the Saw Blade.

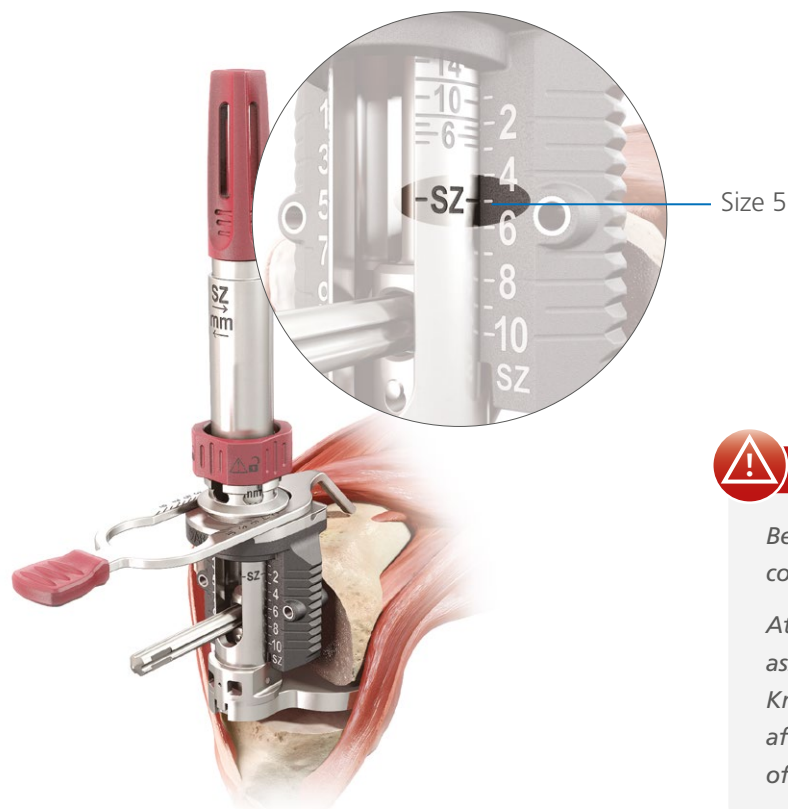
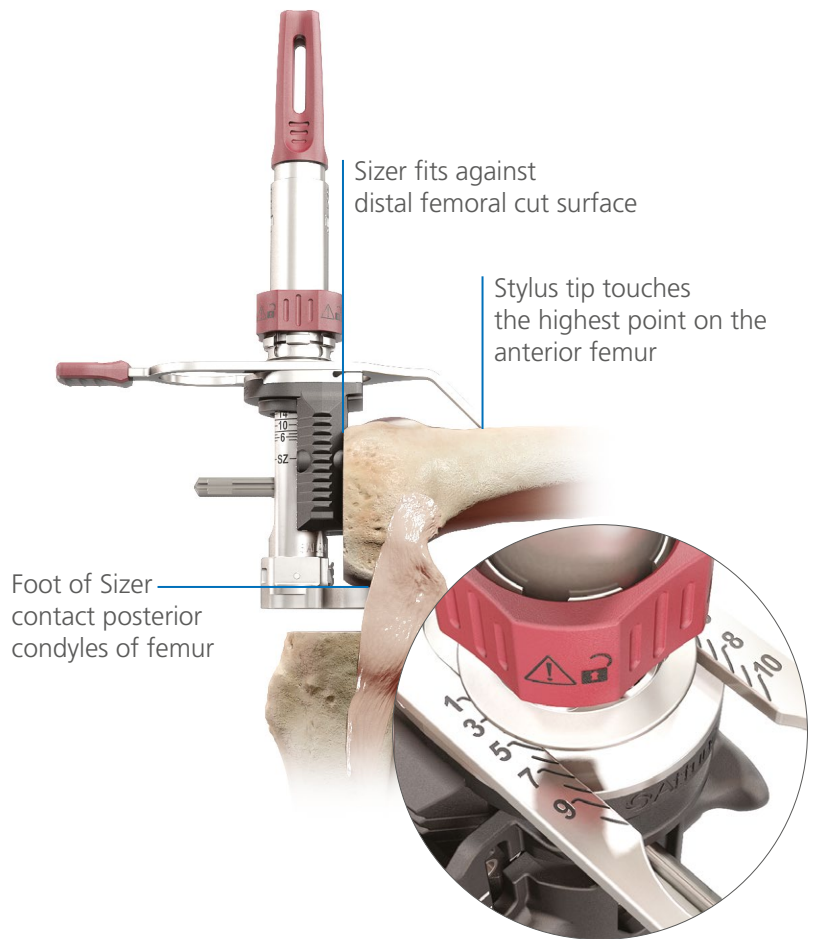

Then determine the femoral component size indicated by lining up the black SZ line on the main body of the balancer with the white numbers on the sizing scale.



CAUTION

Be very careful not to apply a large force when contacting the anterior femur with the Stylus.

At this point in the procedure do NOT lock the assembly by turning the Locking Knob. The Locking Knob should only be turned to lock the assembly after completion of balancing and in preparation of pin placement.

Balanced Femoral Sizing and Rotation

Interpreter for Balanced Sizer

The optional Interpreter performs two functions:

1. It allows the surgeon to visualize the position and rotation of the posterior cut prior to placing reference pins
2. The window feature aids in reading the insert thickness scale relative to the femoral component size selected

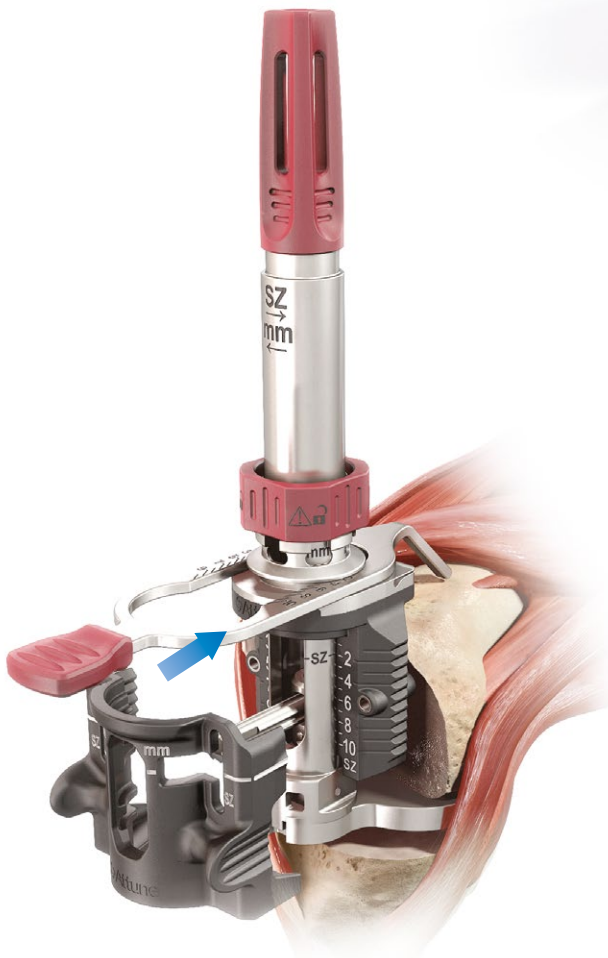

The Interpreter is assembled to the sizer such that the size required is displayed through the window.

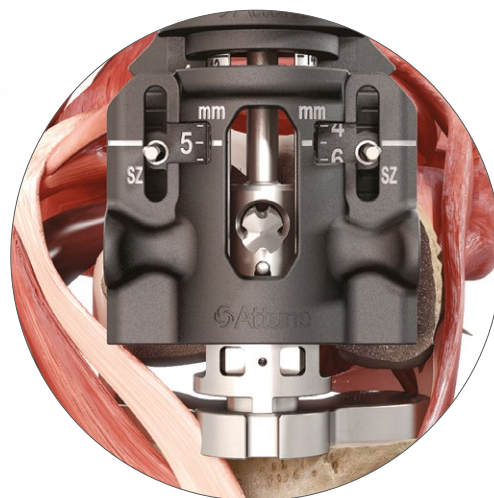

Balanced Femoral Sizing and Rotation

Setting Femoral Rotation

Turn the Tensioning Knob in a clockwise (in the direction of the mm arrow) direction until the flexion gap matches the previously evaluated extension gap.

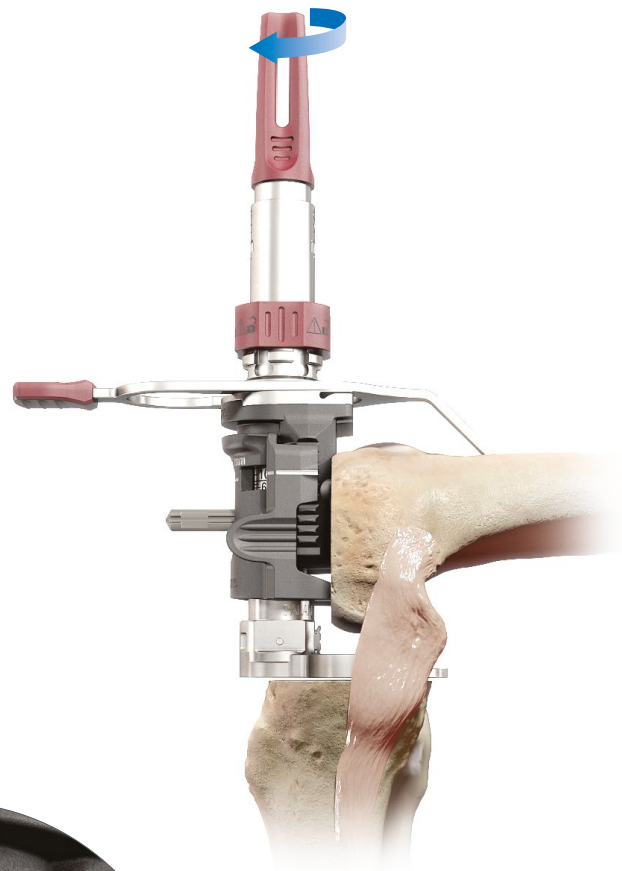

8 mm tibial insert thickness for a size 5 femoral component



INFORMATION

Ensure that the Sizer has good contact with the distal femur.

The leg should be at 90 degrees and the Sizer Foot should rest on the proximal tibia.

As tension is applied the femur rotates, therefore it is important to review and adjust the Stylus to the recommended position which is the highest point on the anterior femur relative to the appropriate size.

To determine the tibial insert thickness read the insert thickness scale (denoted by the black markings on the main body) across from the previously determined femoral size indication (denoted by the high contrast white markings on the sizing scale). e.g. This image indicates an 8 mm tibial insert for a size 5 femoral component.

Balanced Femoral Sizing and Rotation



To assess the ligament tension, hold the tibia firmly and use the Tensioning Knob to apply a Varus/Valgus stress while observing lift off between the Foot and the tibial cut.

Posterior resection level

If further tension is required, turn the Tensioning Knob in a clockwise direction until the next thickness of insert is reached and conduct a further assessment of the ligaments using a Varus/Valgus stress test. If the predicted insert thickness in flexion is not matching the previously evaluated extension thickness, then the surgeon may need to consider moving the femoral component position by 1.5 mm in an anterior or posterior direction, or upsizing or downsizing the femoral component, using the A/P Chamfer Block.

Refer to the "Flexion/Extension Gap Chart" section for further gap balancing information.



CAUTION

Over-rotation of the lateral condyle in the anterior direction could result in excessive external rotation of the femoral component and could be an indication of over-tightening.

The posterior feet of the Interpreter may be used to visualize the position and rotation of the posterior resection.

Balanced Femoral Sizing and Rotation

Verify the appropriate position of the Stylus, then, lock the assembly in place by rotating the Locking Knob clockwise. Insert Universal Pins into the Pin Holes on each side of the Sizing Scale.

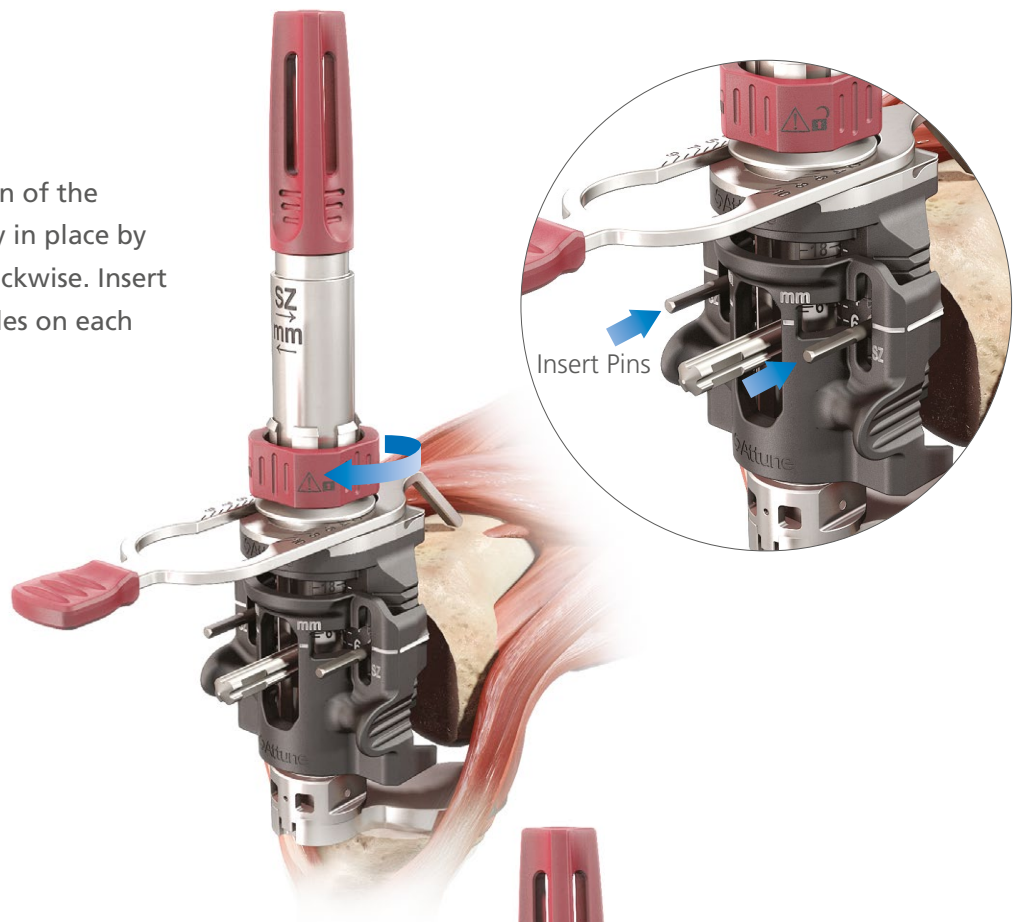

Remove the Balanced Sizer. First unlock the Locking Knob and release the tension by turning the Tensioning Knob in a counterclockwise direction. Attach the Rod Handle and remove the IM Rod with the Tapered Plug, engage the Tapered Plug with the guide to remove it from the bone.

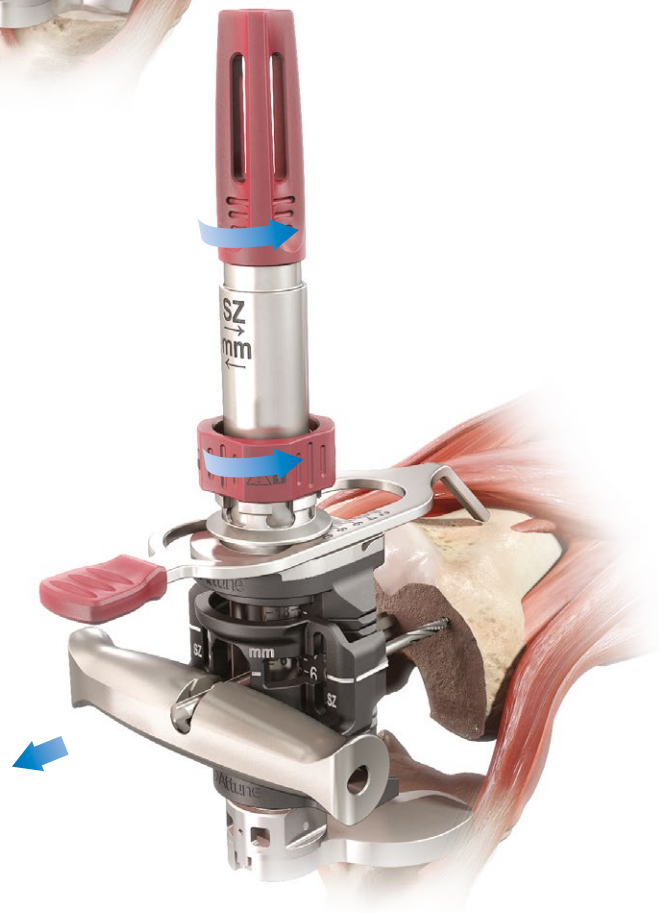

Femoral Preparation

A/P Chamfer Block

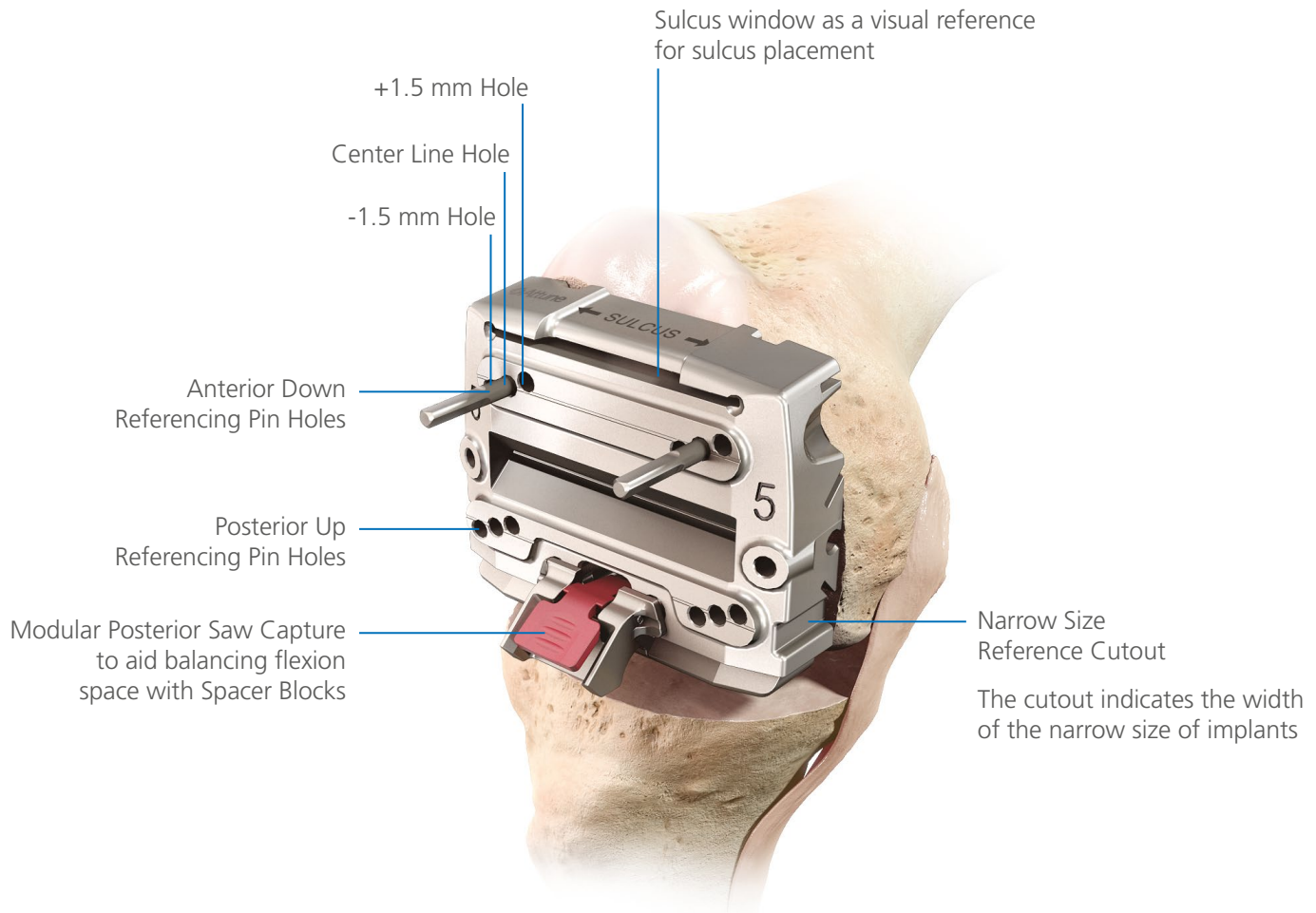

INFORMATION

The ATTUNE Knee System femoral components increase in size by a consistent 3 mm in the A/P direction. The INTUITION A/P Chamfer Blocks allow the surgeon to adjust the A/P position of the femoral component by 1.5 mm in either direction.

This creates the intra-operative flexibility to position the femoral component based on the surgeon's assessment of the flexion gap and the desired posterior condylar offset. See page 102 for more information on gap balancing. If there is no cutout, a narrow component is not available for that size. Narrow components are available for sizes 3, 4, 5 and 6.

Femoral Preparation



A/P and Chamfer Cuts

Select the A/P Chamfer Block that matches the femur size. Place the Block over the two anterior or posterior Universal or Non-Headed Pins through the pin holes marked with a center line.

The flexion space can be checked by using a Spacer Block placed below the A/P Chamfer Block with the Modular Posterior Saw Capture removed.



INFORMATION

When using the anterior offset pin holes, changing the size of the femoral component will alter the posterior femoral condyle resection.

To evaluate femoral size adjustments without altering the posterior femoral cut, place the A/P Chamfer Block onto the anterior Universal Pins and insert two additional pins through the posterior up holes on the Block.

Then remove the anterior reference pins. This enables the femoral implant size to be adjusted without altering the flexion gap.

Alternatively, the Block can be moved 1.5 mm up or down (one hole location) to adjust the flexion gap, if necessary.

Femoral Preparation



INFORMATION

Good pinning technique is critical to achieving accurate bone cuts during the anterior and posterior resections. The recommended technique is to avoid stripping the

Threaded Headed Pins in the divergent pin holes and to retain the straight pins during anterior and posterior resections for added stability.

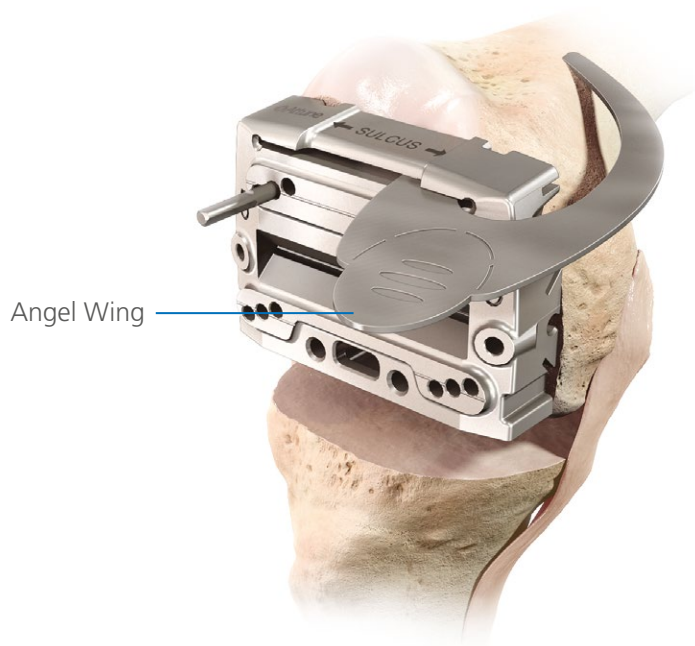

Angel Wing

Use an Angel Wing to confirm the location of the cut and the degree of rotation. The Block can also be used at this stage to assess the M/L width of the implant size for both the standard or narrow sizes.

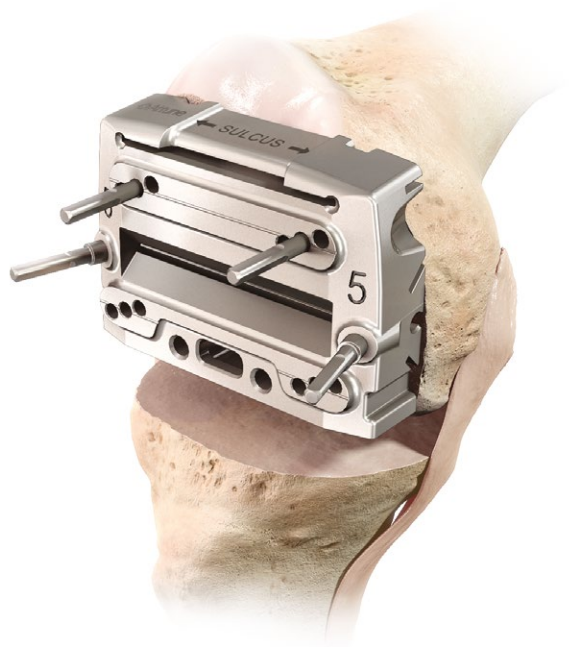

Insert Threaded Headed Pins into the divergent pin holes on the medial and lateral aspects of the A/P Chamfer Block.

Femoral Preparation



INFORMATION

INTUITION A/P Chamfer Blocks were designed to ensure the femoral trial and implant seats fully on the distal femur by preparing the chamfer cuts with additional clearance.

Therefore, a small "gap" may be observed between the femoral trial/implant and the chamfer cuts, particularly the anterior chamfer.

This gap is intentional by design to ensure that fixation is achieved with the distal, anterior, and posterior surfaces. In this way, the position of the femoral component can be best controlled with regards to flexion and extension gaps.

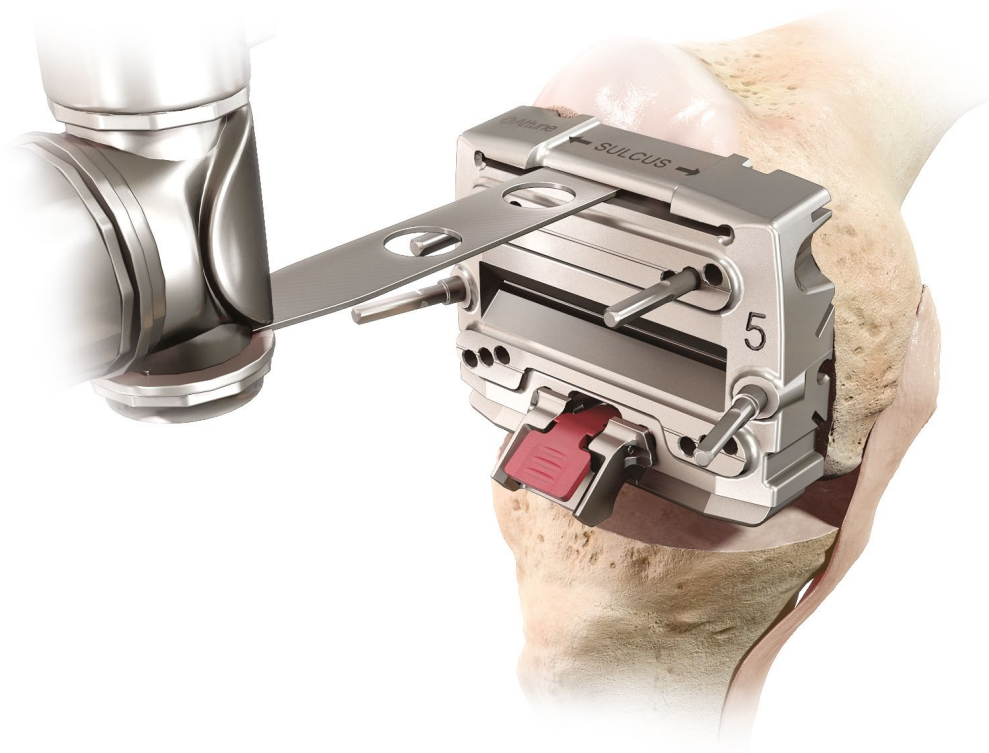

Recommended: Re-attach the appropriate size Modular Posterior Saw Capture to the A/P Chamfer Block to provide for capture guidance on all cuts.

Femoral Preparation

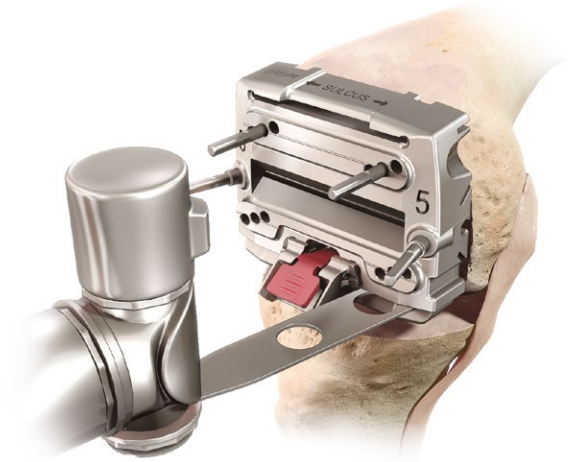

Place Retractors to protect the medial and lateral collateral ligaments and the popliteal tendon. Then resect the anterior and posterior femur, as well as the anterior chamfer if posterior referencing or posterior chamfer if anterior referencing.

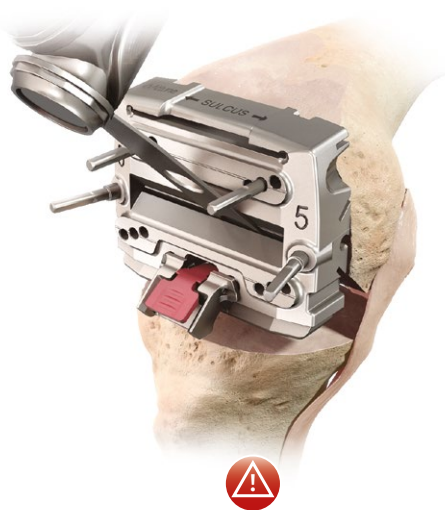

Remove the Universal or Non-Headed Pins and cut the remaining anterior or posterior chamfer. Remove the Threaded Headed Pins and the A/P Chamfer Block.



CAUTION

It is recommended to revisit the anterior and posterior femoral cuts after the initial resection to avoid the effect of Saw Blade skiving.



INFORMATION

The posterior Saw Captures are open medially and laterally to accommodate complete saw cuts. To reduce the risk of inadvertent Saw Blade kickout, point the Blade slightly toward the midline before starting the Saw.

Posterior Condyle Preparation

Removal of Excess Bone

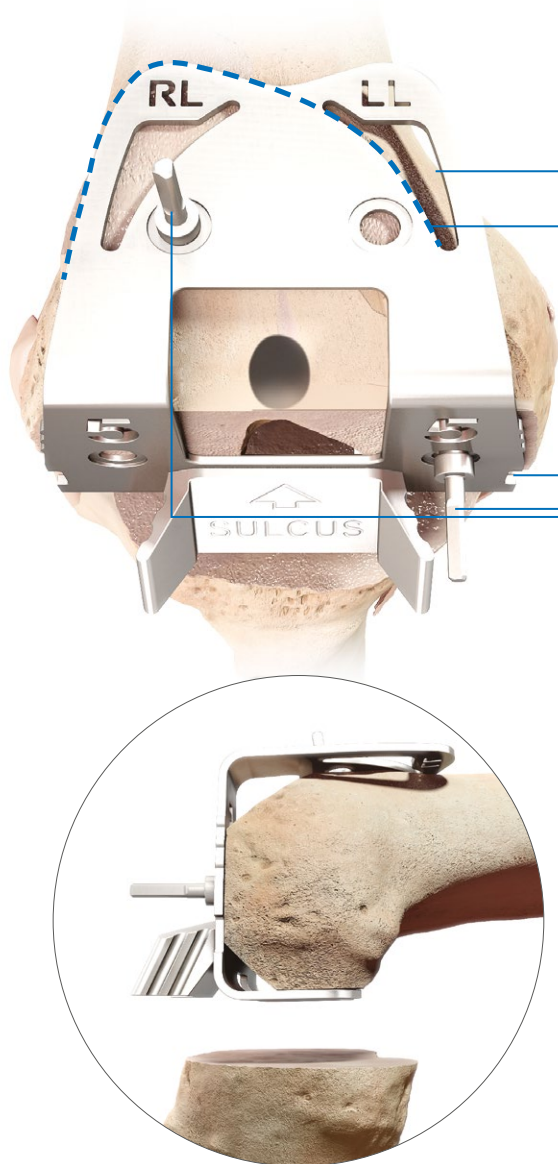

Reference Window

Dotted lines indicate the outer edges of the final component

Cutouts indicate narrow size

For optimal stability, place Base Pins as shown

To avoid impingement in flexion, remove any excess bone between the posterior tibial implant and the posterior femoral condyles in flexion. To aid in osteophyte and excess bone removal, select the Femoral Finishing Guide that corresponds to the femoral trial component size. Push the instrument onto the resected distal femur and position mediolaterally, using the lateral anterior profile of the instrument as a guide. The inner surface of the windows represents the anterior medial aspect of the implant and the outside profile of the anterior face represents the anterior lateral aspect of the implant.

Fix the instrument flush to the distal cut using 4.7 mm diameter Base Pins.



INFORMATION

The cutouts on the sides of the Femoral Finishing Guide show where the outer edge of the narrow component is located. If there is no cutout, a narrow component is not available for that size. Narrow components are available for sizes 3, 4, 5 and 6.



Base Pin

Posterior Condyle Preparation

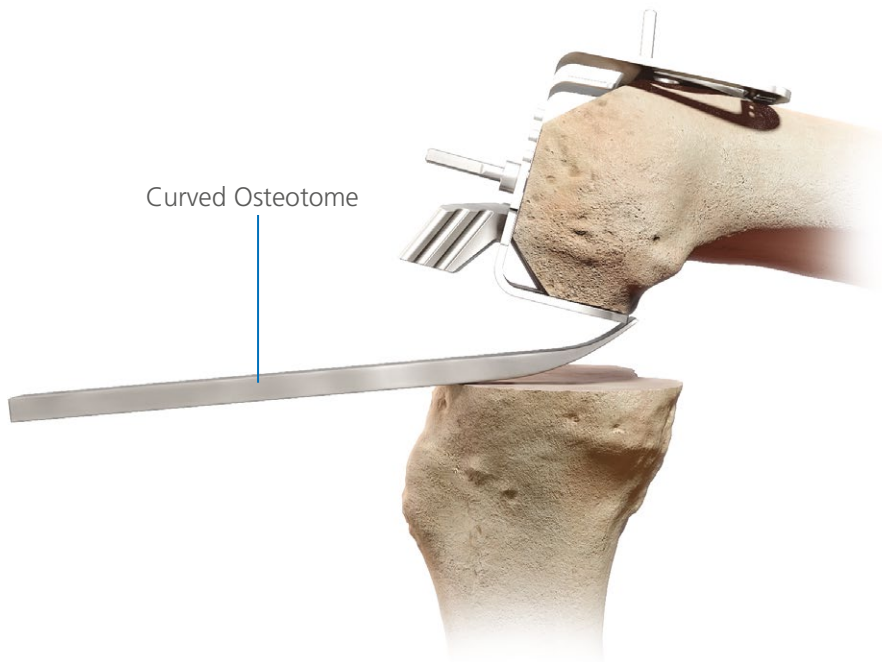

Removal of Excess Bone (Cont.)

With the Femoral Finishing Guide in place, verify that any excess bone or residual osteophytes in the posterior recesses have been removed. If not, use a Curved Osteotome or Gouge to remove any remaining bone that can be seen beyond the end of the Femoral Finishing Guide feet.

Always work carefully under direct vision to avoid damage to the neurovascular structures in the popliteal fossa.

CR Sulcus Femoral Preparation

When implanting an ATTUNE Knee System CR component, use the Femoral Finishing Guide to perform the sulcus cut. Using the Sulcus Cut Ramp as a guide, remove bone from the sulcus with the Rasp, a 0.5 in. Saw or Osteotome. Then remove the Femoral Finishing Guide.

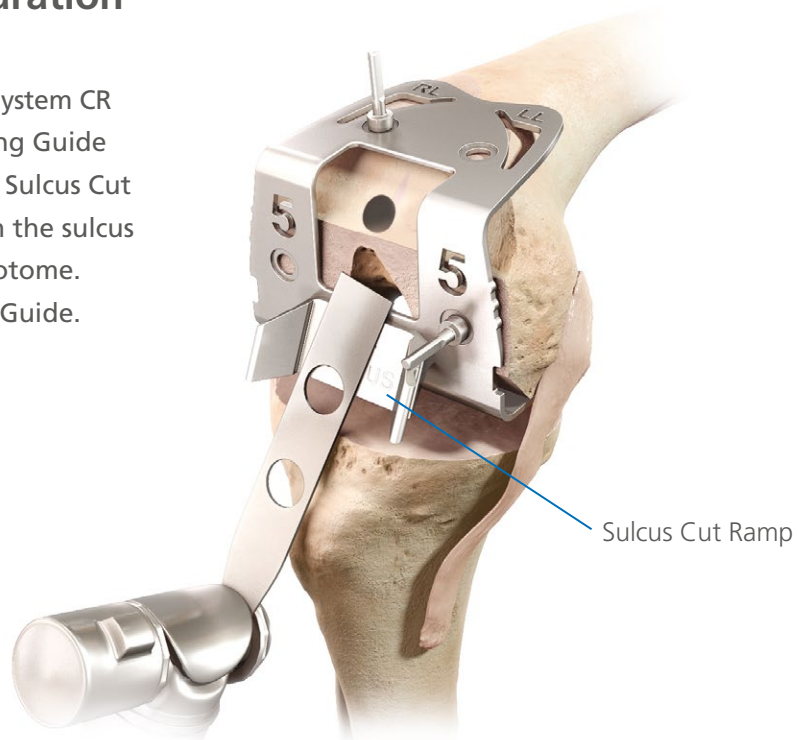

Femoral Resection – PS Femoral Notch Cuts

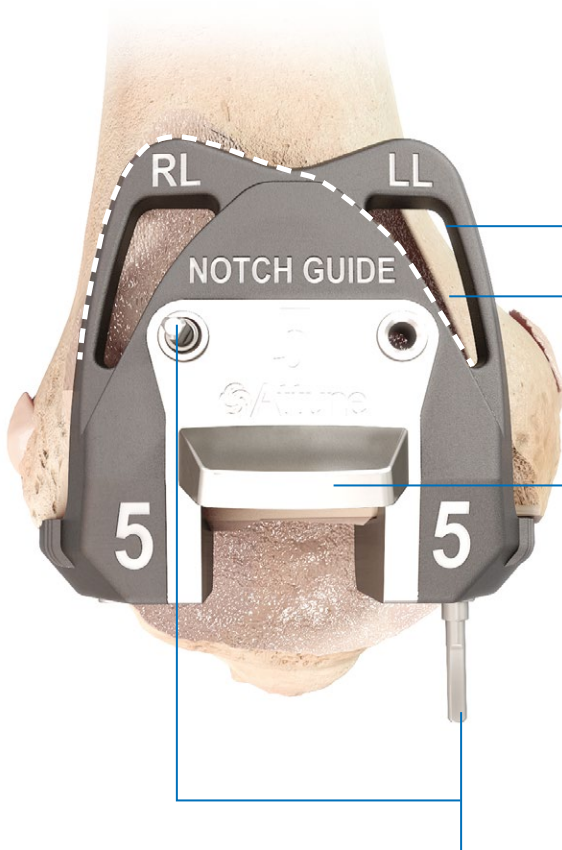

Reference Window

Dotted lines indicate the outer edges of the final component

The tongue of the Notch Guide is extended to provide a long cutting surface for an 18 degree cut

For optimal stability, place Threaded Headed Pins as shown

When implanting an ATTUNE Knee System PS component, use the Notch Guide to perform the notch cut. The profile of the Notch Guide provides anterior and distal references to the width of the implant. In addition, windows in the Notch Guide provide additional reference.

The inner surface of the windows represents the anterior medial aspect of the implant and the outside profile of the Notch Guide represents the anterior lateral aspect of the implant. The references are designed to confirm optimal component size and position. The tongue of the Notch Guide is extended to provide a long cutting surface for an 18 degree cut.

Position the Notch Guide on the resected anterior and distal surfaces of the femur as far laterally as possible while assuring that the lateral border of the implant does not overhang the lateral femoral cortex. Pin the Guide in place using the Threaded Headed Pins.



INFORMATION

The cutouts on the sides of the Notch Guide show where the outer edge of the narrow component is located. If there is no cutout, a narrow component is not available for that size. Narrow components are available for sizes 3, 4, 5 and 6.

Femoral Resection – PS Femoral Notch Cuts

Perform the notch cut. 

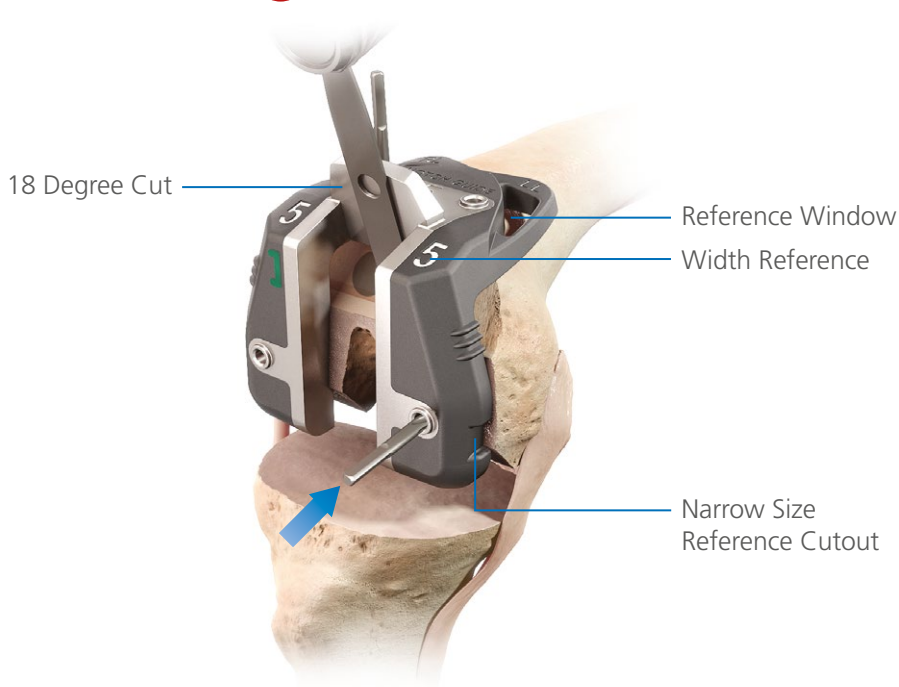

CAUTION

When completing the notch cut, be careful to avoid excessive angulation of the Saw Blade or penetration past the posterior femoral cortex to avoid injury to the neurovascular structures.

Avoid undercutting the condyles.

Trial Reduction

Position the appropriate Femoral Trial onto the femur by hand. Use the ATTUNE System Impactor to impact the trial as necessary.

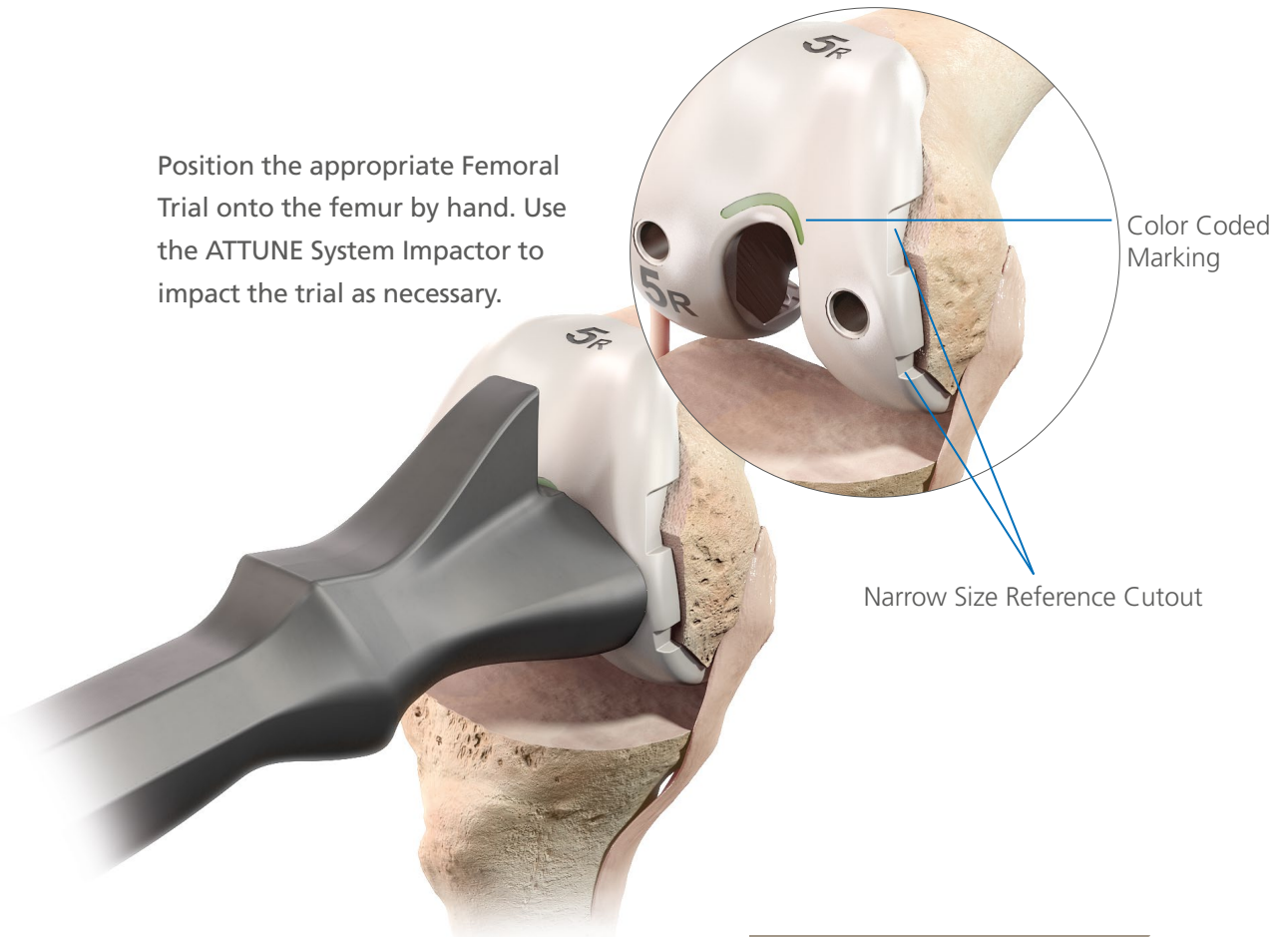

Femoral Component Indicators	
CR	
PS	



INFORMATION

If the trial is not seating properly, the bone cuts may need to be rechecked. Excessive impaction required is a signal that under-resection has occurred of the AIP Chamfer cuts, or of the Sulcus cut in a CR configuration.

In a PS configuration, this could also be an indication of underresection of the Notch Guide cuts. Femoral Trial MIL width of box is representative of implant and cement mantle. The Femoral Trial should be fully seated prior to joint reduction.



INFORMATION

The cutouts on the sides of the Femoral Trial show where the outer edge of the narrow component is located. If there is no cutout, a narrow component is not available for that size. Narrow components are available for sizes 3, 4, 5 and 6.

Trial Reduction

Femoral Trial Gripper (Optional Instrument)

Insertion

Position the appropriate Femoral Trial onto the femur by hand or using the Femoral Trial Gripper. Squeeze the Femoral Trial Gripper slightly until the prongs align with the lug holes of the Femoral Trial. Continued pressure should be applied to the Gripper to maintain a secure grip between the Gripper and the Femoral Trial.

If the Femoral Trial Gripper is used to position the Femoral Trial, remove the Gripper and use a Femoral Impactor to fully seat the trial.

Extraction

To extract the Femoral Trial, place a Femoral Trial Gripper in the lug holes and remove by hand. Optionally, use a Mallet to lightly tap the extraction surface until the Trial is removed.



CAUTION

The Femoral Trial Gripper should not be used to fully seat the Trials as the prongs protrude past the distal surface of the Trial.

The Femoral Trial Gripper can be used for Sizes 3 - 10 only.

When extracting the Trial, rocking it medio-laterally may cause condylar fracture. Such rocking should be avoided.

Soft Tissue Considerations for Cruciate Retaining Application

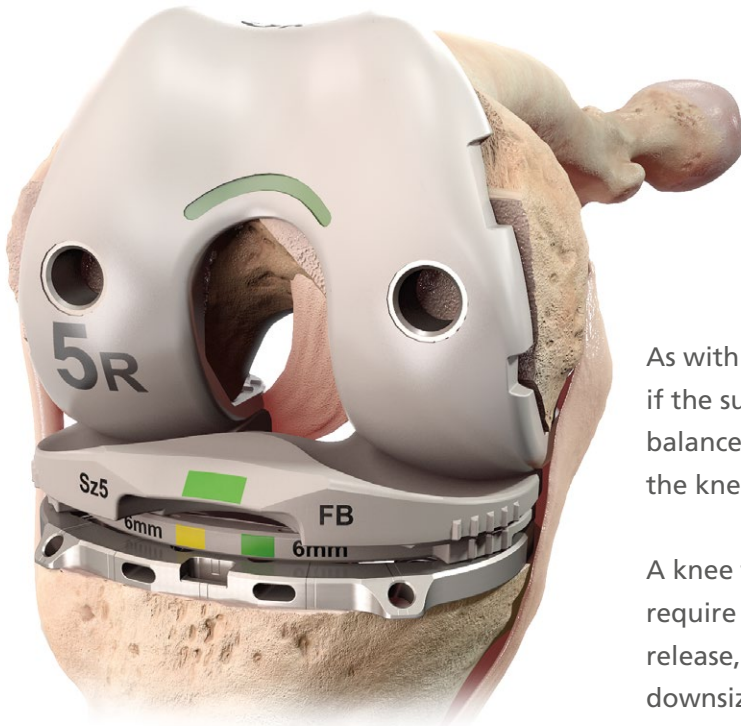

As with any cruciate retaining total knee replacement, if the surgeon plans to preserve the PCL, attention to PCL balance is extremely important for proper kinematics of the knee.¹

A knee that is tighter in flexion than extension may require one or a combination of the following: PCL release, increasing the amount of tibial slope, or downsizing the femoral component.¹

During trialing, the surgeon should select the trials that provide the greatest stability in flexion while still allowing full extension. Indications of an excessively tight flexion space may include one or more of the following:

- Femoral trial lifting off
- Tibial trial lift off or booking
- Excessive rollback of the femoral component on the tibia

If there is any indication of imbalance, it is not uncommon to perform a gradual release of the PCL.

Trial Components

Tibial Trial

Attach the Alignment Handle to the appropriate size Tibial Base Trial and place onto the resected tibial surface. Assess the position of the base to maximize tibial coverage while avoiding overhang. Alternatively, the Low-Profile Tibial Pin Puller can be used to posteriorly pin the Base Trial to the proximal tibia using the Posterior Low-Profile Tibial Pins. For Fixed Bearing, the rotation of the Tibial Base Trial is typically centered on the junction between the medial and central third of the tibial tubercle.

Rotating Platform

For Rotating Platform tibial components, secure the Impaction Handle to the Spiked Evaluation Bullet and insert the Bullet into the cutout of the Base Trial. Tap down lightly on the Impaction Handle to secure the Base Trial to the proximal tibia.

Fixed Bearing

For Fixed Bearing tibial components, snap the Fixed Bearing (FB) Float Evaluation Bullet into the cutout of the Base Trial by hand. The FB Float Evaluation Bullet is used when allowing normal internal/external rotation of the tibial component during a range of motion to dictate the optimal placement of the Base Trial. The bone can be marked for the Base Trial orientation reference.

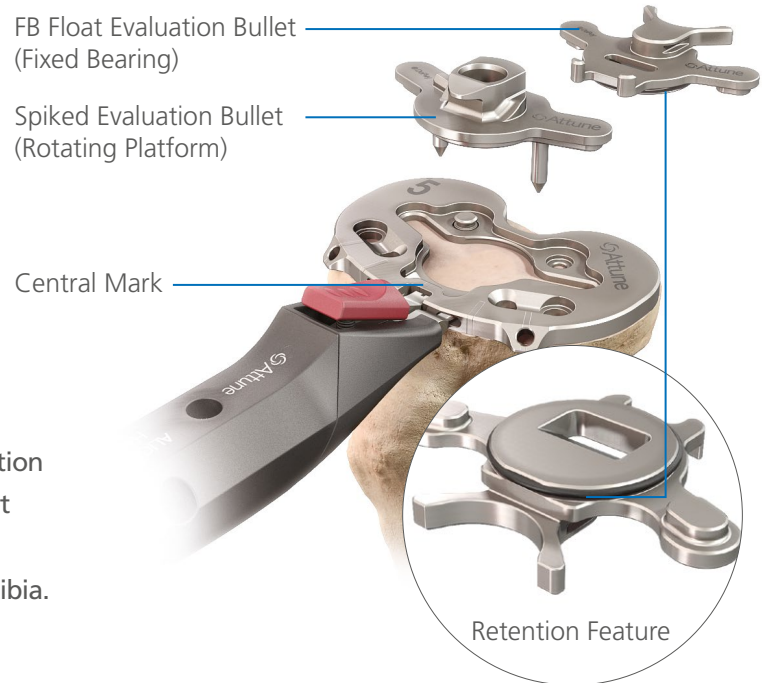
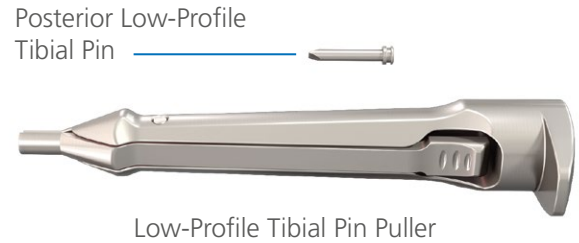

INFORMATION

When implanting a Rotating Platform, it is recommended to use the Impaction Handle to guide the Spiked Evaluation Bullet. Either Rotating Platform or Fixed Bearing tibial components can be trialed before preparing the tibia. Pinned Tibial Base Trials sizes 1 and 2 do not have posterior pinholes.

Trial Components

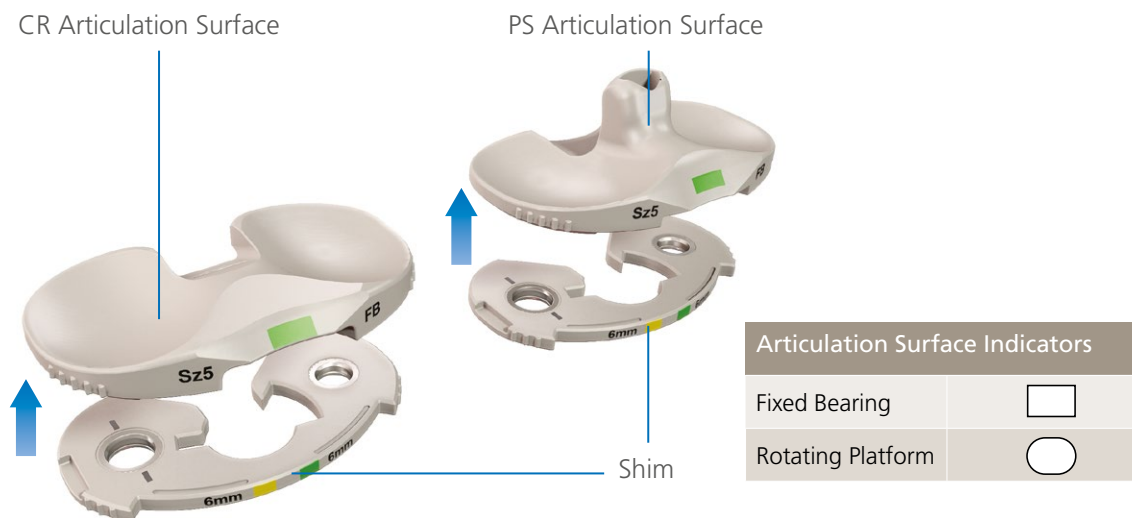

Select the Tibial Articulation Surface Trial that matches the femoral size and style (CR or PS for either Rotating Platform or Fixed Bearing), and attach the corresponding size Shim of the appropriate thickness (5 mm, 6 mm, 7 mm, 8 mm, 10 mm, 12 mm, 14 mm and 16 mm for CR and PS, and in addition 18 mm for PS, for core sizes 3 - 8).

The thickness markings on the insert trials and the final insert implant indicate the insert thickness without the base thickness included. For further information, see the chart on page 103. For alternative technique please see Appendix 4.

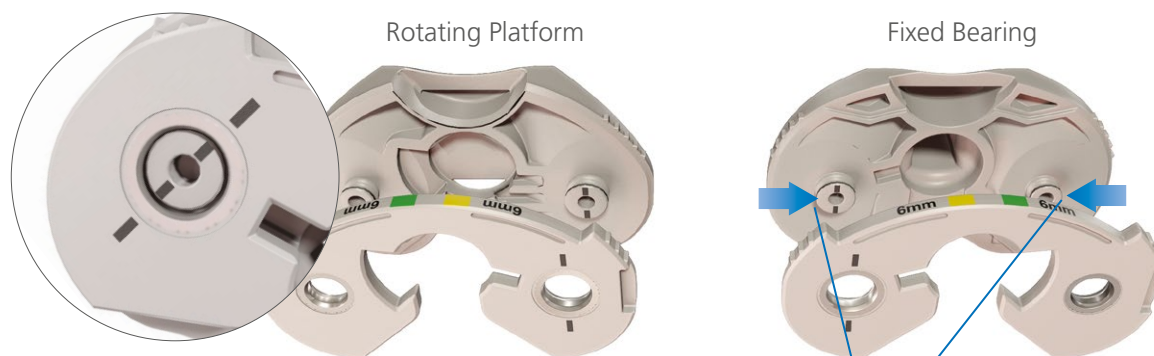

The Shims are reversible to accommodate both Rotating Platform and Fixed Bearing implants. Ensure that the Articulation Surface Trial and Shim are securely engaged, as these two components make up the Insert Trial. Attach the assembly into the Tibial Base Trial.

Check for Bal Seal® Spring damage. If damage is observed, replace the damaged component.

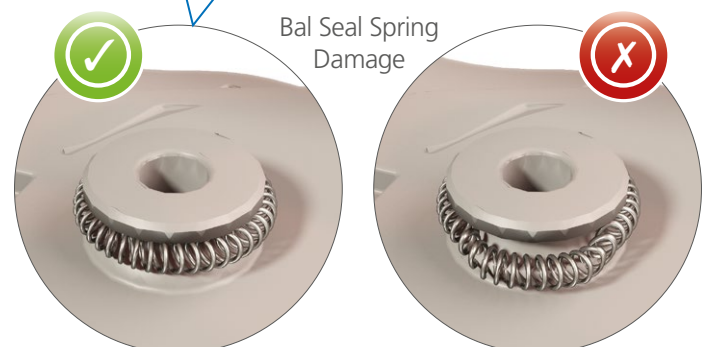

Trial Components

Remove the Alignment Handle from the Tibial Base Trial and, with the trial prosthesis in place, extend the knee carefully, noting the anteroposterior and mediolateral stability, and the overall alignment in the A/P and M/L planes. If there is any indication of instability, use the next thicker Shim and repeat the check. Select the trial assembly that provides the greatest stability in flexion while still allowing full extension. Verify that the posterior femoral condyles are sufficiently prepared to prevent impingement on the tibial insert in deep flexion.



Re-attach the Alignment Handle to the Tibial Base Trial and then attach the two-part Alignment Rod to the Alignment Handle and confirm the overall alignment. For a Fixed Bearing component, mark the position of the trial component on the anterior tibial cortex.

Alternatively, the Low-Profile Tibial Pin Puller can be used to anteriorly pin the Base Trial to the proximal tibia using the Anterior Low-Profile Tibial Pins.

Trial Components

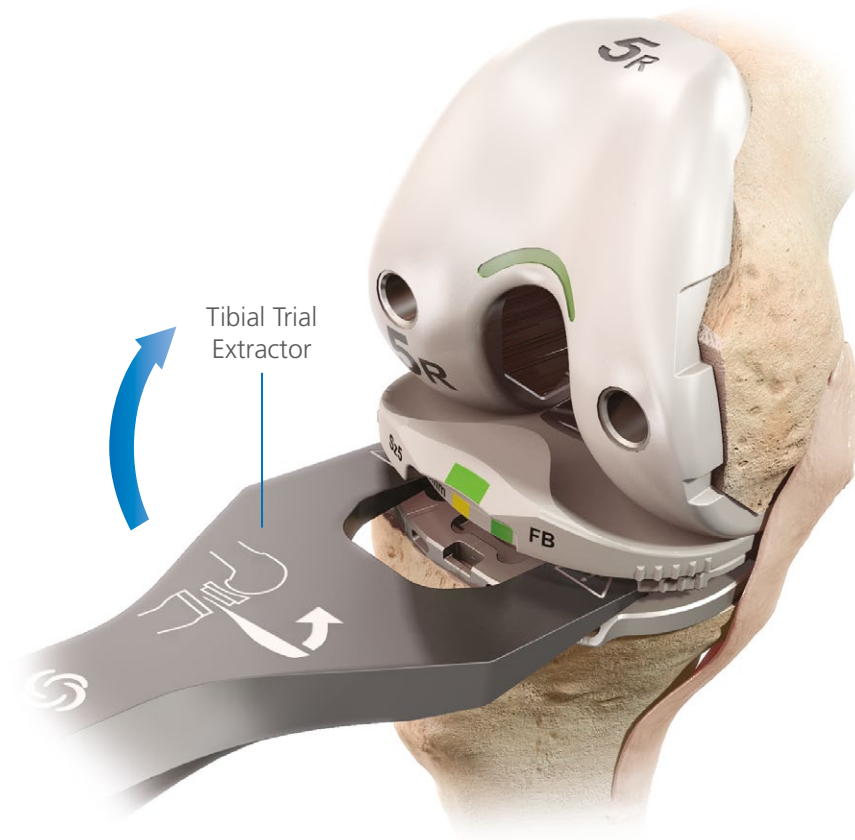

Fully flex the knee, and remove the Insert Trial. The Tibial Trial Extractor can be used to aid in the removal of the Insert Trials.

Insert the Tibial Trial Extractor between the Tibial Base Trial and the Shim, and lever the handle upwards toward the femur in order to remove the Insert Trial.



CAUTION

Do not insert the Tibial Trial Extractor between the Shim and the articulation surface to prevent damage to the connection feature.

When removing the Tibial Trials with the Tibial Trial Extractor, avoid engaging the Keel Punch to prevent damage to the Tibial Trial Extractor.

Tibial Preparation

Re-attach the Universal Handle to the Tibial Base Trial and re-insert it on the resected tibial surface, (aligning it with the mark on the bone for a Fixed Bearing Tibial Construct).

Attach the Tibial Drill Tower to the Tibial Base Trial by inserting the spikes on the underside of the Tower through the two inside holes on the anterior aspect of the Base Trial. The spikes provide fixation for both the Drill Tower and the Base Trial. If additional fixation is desired, place Base Pins through the two outside holes on the anterior aspect of the Base Trial.



If desired, use the appropriate size Tibial Drill Stop.

Use the Tibial Drill to ream the tibia to where the line marked on the side of the Drill aligns to the top surface of the tower. The Line marking corresponds to the Tibial Base size. Bone debris from drilling could prevent the Keel Punch from seating completely in the Base Trial. To prevent this, flush out the cavity after drilling.

Base Pins
(Optional)

Optional Drill Stop



CAUTION

Care should be taken not to protrude through the medial tibial cortex if using the medial Base Pin.

Care should be taken not to overdrill. An optional Drill Stop is available.

Tibial Preparation



Keel Punch

Attach the correct size Keel Punch to the Impaction Handle, and insert the assembly into the Tibial Drill Tower. Impact the assembly into the cancellous bone until the Keel Punch is seated flush on the Tibial Base Trial. Use the anterior window in the tower to monitor the progress of the Keel Punch while impacting.

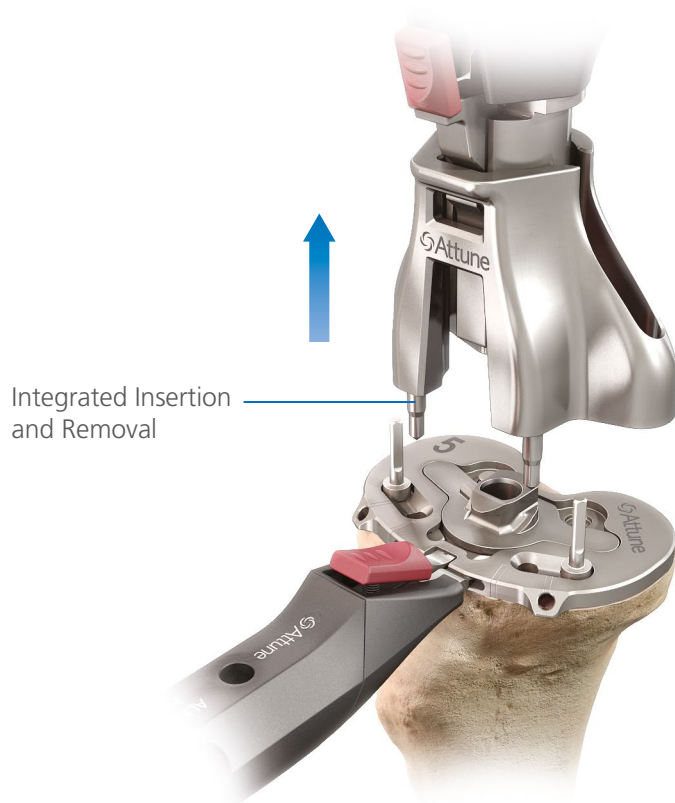

When the Keel Punch is fully seated, the Impaction Handle will automatically disengage from the Keel Punch, allowing the Impaction Handle and the Tibial Drill Tower to be removed together.

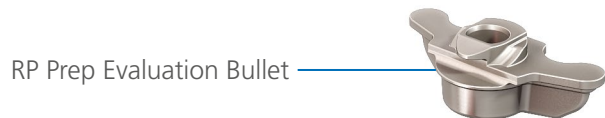

INFORMATION

Optional: If desired, perform a final trial reduction by inserting the appropriate trial components and repeating the previous trial evaluation. The FB Prep Evaluation Bullet or RP Prep Evaluation Bullet can be used in place of the Keel Punch to aid in the insertion and extraction of the insert trials during a final trial reduction.

Patella Resection and Preparation – Instrument Assembly

Patella Resection Guide

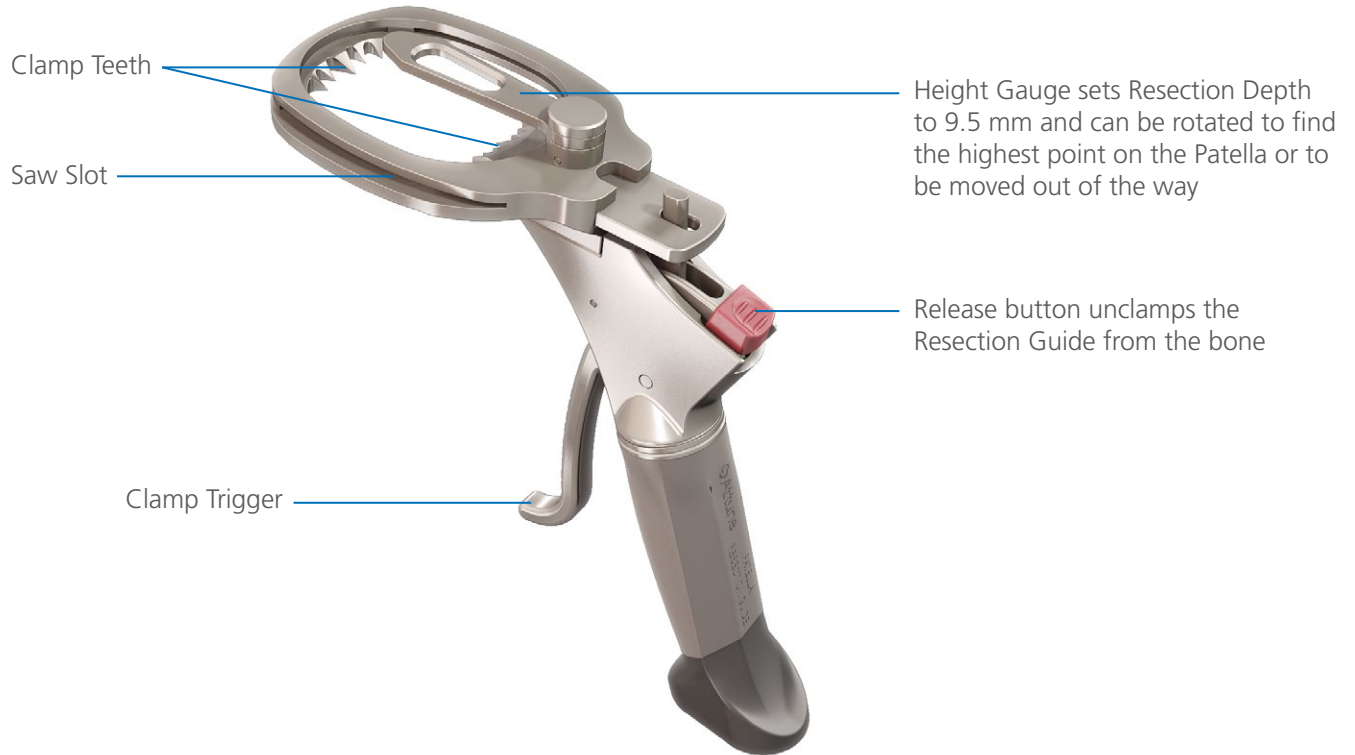

Patella Drill Trials



Assemble by inserting the Trial Handle into the slot on the Drill Trial until it clicks into place

Patella Resection and Preparation – Instrument Assembly

Patella Drill Clamp

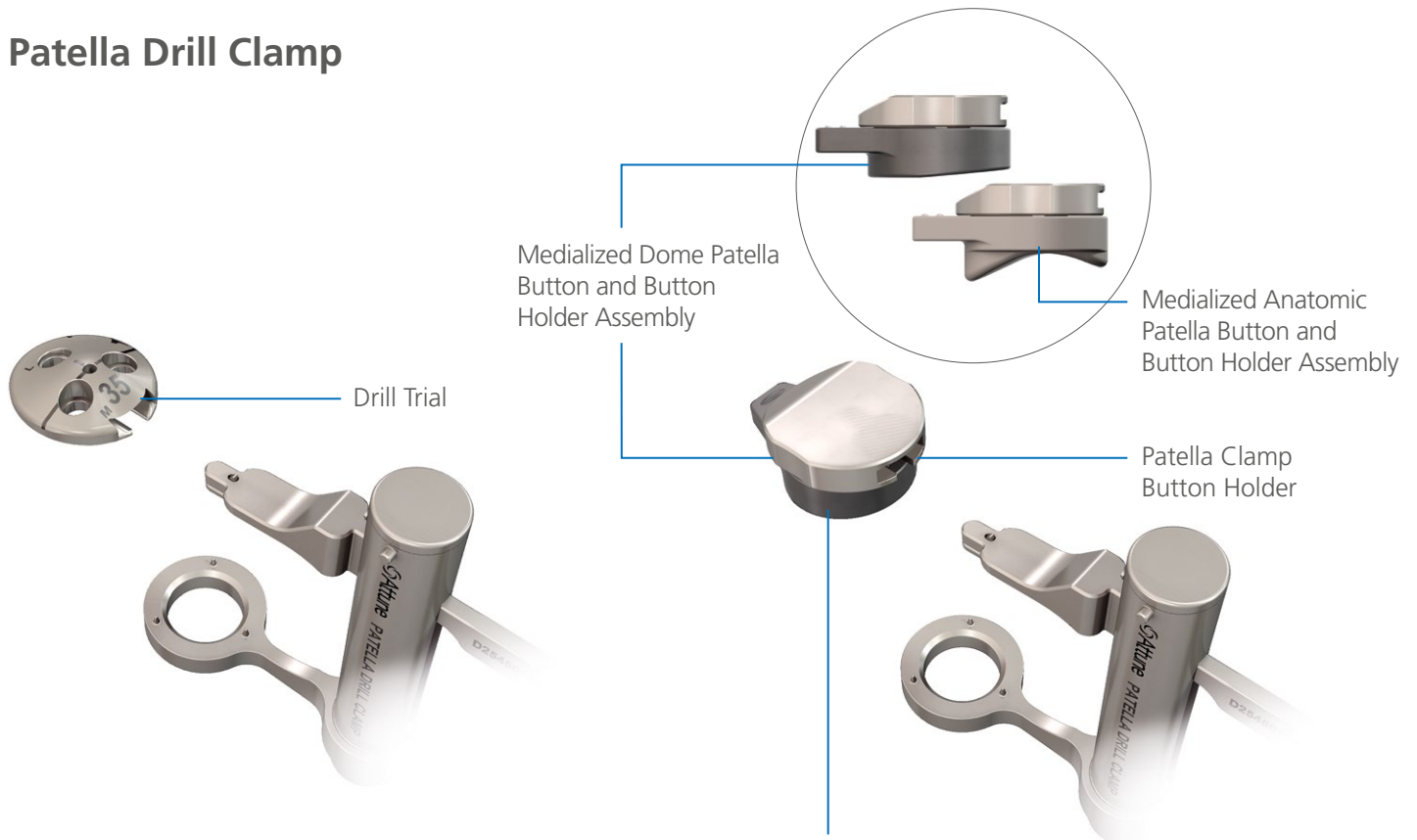

A Medialized Dome or Medialized Anatomic Silicone Button is assembled to the Patella Clamp Button Holder to protect the implant surface during cement pressurization

Clamp Connection Post attaches to either the Drill Trials or Patella Clamp Button Holder with a snap-on mechanism

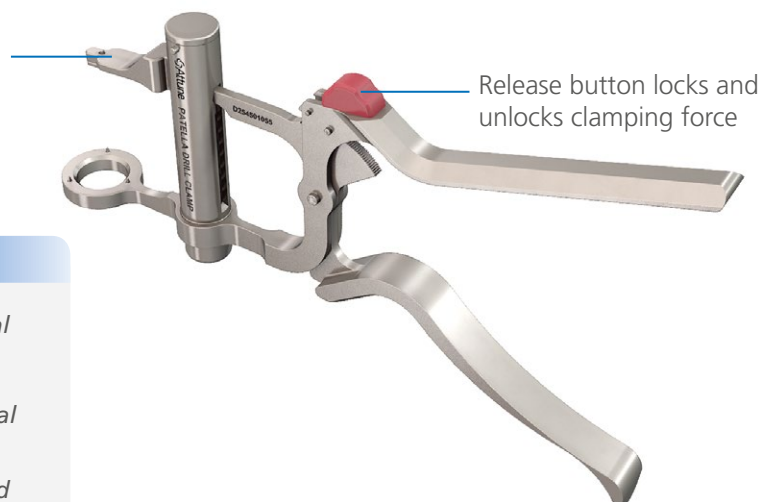

i INFORMATION

The patella instrumentation is designed for a medial approach only.

The clamp and trial handle are designed for a medial approach only. The Resection Guide and Drill Trials (used as stand alone without the clamp) can be used for a medial or lateral approach.

Patella Resection



Use the Caliper to estimate the thickness of the patella and evaluate the level of bone resection. The Height Gauge on the Patella Resection Guide accounts for a resection of 9.5 mm of bone, which is the average thickness of the ATTUNE Knee Systems Patellae.



Patella Guide Shim



Place the leg in extension and evert the patella.

Position the Patella Resection Guide so the Height Gauge is against the articular surface of the patella. Align the serrated jaws at the medial and lateral margins of the articular surface. Engage the largest tooth on the lateral side then engage the largest tooth on the opposite side to temporarily secure the clamp while allowing for rotation of the patella until the inferior and superior orientation is achieved and clamp fully.



CAUTION

If the patellar thickness is less than 21.5 mm, the thickness of the bone remaining after resection would be less than 12 mm and resecting less bone should be considered.

If less resection is required, the Patella Guide Shim is available which reduces the depth of the resection to 7.5 mm.



INFORMATION

The resection extends from the medial chondro-osseous junction to the lateral chondro-osseous junction.

Patella Resection

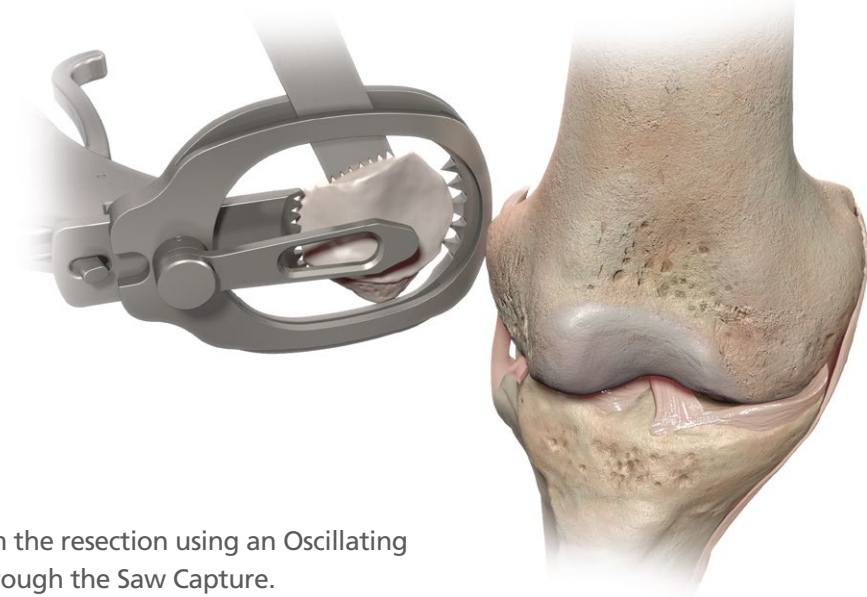

Perform the resection using an Oscillating Saw through the Saw Capture.

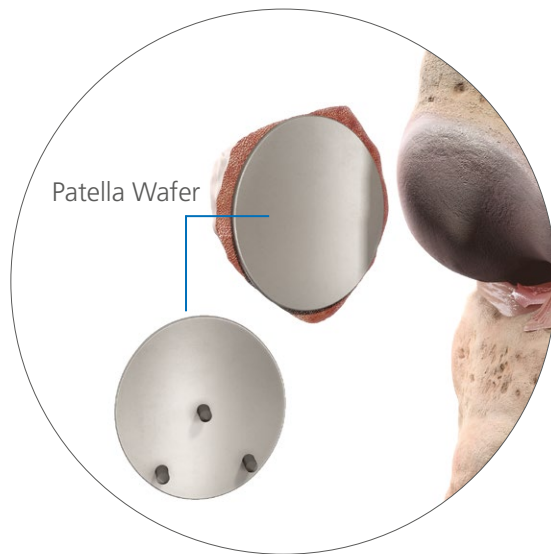

If desired, place a Patella Wafer on the resected surface by hand to protect the patellar bone bed.



INFORMATION

When resecting the patella, care should be taken to avoid Saw Blade excursion into the Femoral Trials or Implants.

Patella Preparation

Patella Implant Options



Medialized Anatomic Patella



Medialized Dome Patella

Patella Size Chart	
Size	Thickness
29	8.5 mm
32	9 mm
35	9.5 mm
38	10 mm
41	10.5 mm

Two patella options are available, the Medialized Dome Patella or the Medialized Anatomic Patella.

The Medialized Anatomic Patella is designed to be conforming with the femoral component and has a built in range of +/- 15 degrees freedom of rotation from its optimal position. Therefore, accurate alignment of the Patella Drill Trial is important for proper patella placement and tracking.

The following steps will aid in accurate alignment of both patella designs, but is particularly critical for the Medialized Anatomic Patella.

Patella Preparation

Patella Drill Trialing

If used, remove the Patella Wafer from the patella. Place the Patella Drill Trial on the resected patella to assess bone coverage. Select the correct size of Patella Drill Trial for maximum patella bone coverage. Verify the medial lateral location of the patella implant apex relative to the native anatomy ridge.

For an alternative technique, see Appendix 1 on page 73.



Patella Preparation

Patella Drill Trialing

Press the trial onto the bone manually or with the Patella Modular Clamp and Clamp Ring to engage spikes.

The Drill Trials have one larger central spike to allow engagement of only the central spike so that the Drill Trial may be rotated about the central axis to aid in assessment of its optimal position prior to being fully seated on bone.

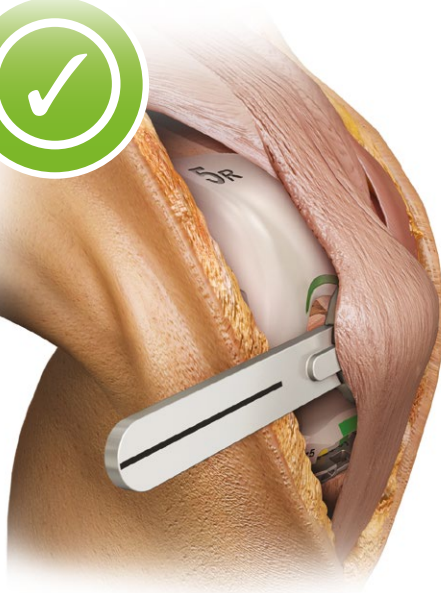
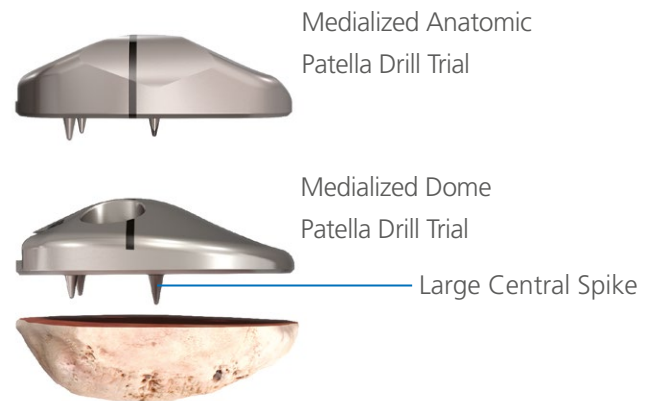

Correct trial handle alignment

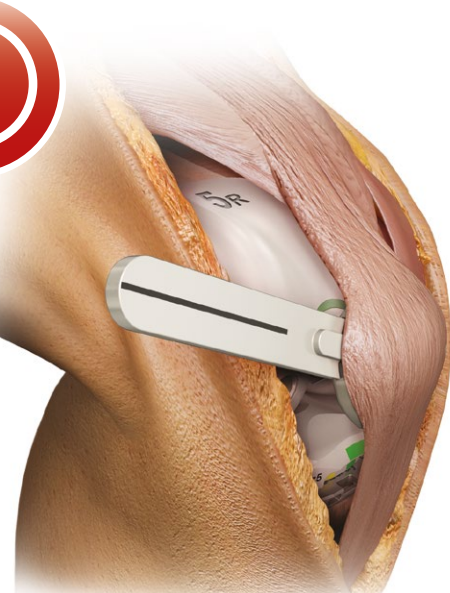

Incorrect trial handle alignment



INFORMATION

In a case where a short patella tendon raises concern about the Medialized Anatomic Patella contacting the top of the spine of the PS femoral component, it is recommended to downsize the patella, superiorize and medialize its position. If that recommended positioning does not resolve the concern, the surgeon should consider using the medialized dome patella.

Lug Hole Preparation

Patella/Femoral Lug Drill

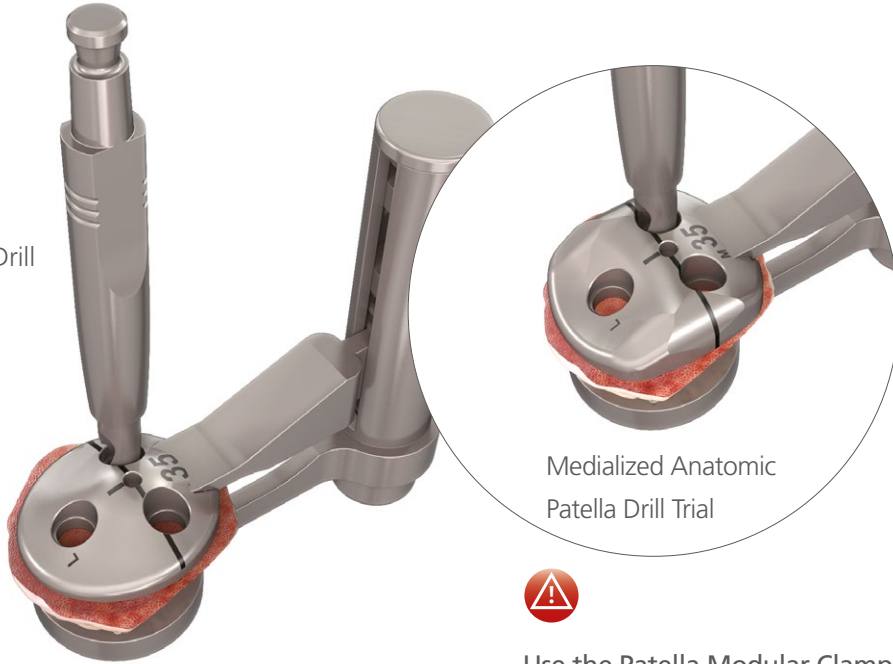

Medialized Dome Patella Drill Trial

Medialized Anatomic Patella Drill Trial



Use the Patella Modular Clamp to secure the Drill Trial if desired. Drill the holes using the Patella/Femoral Lug Drill.

Femoral Lug Hole Preparation

Drill the femoral lug holes through the Femoral Trial using the Patella Femoral Lug Drill. It is recommended to perform this step after patella trialing to ensure adequate medial/lateral placement.

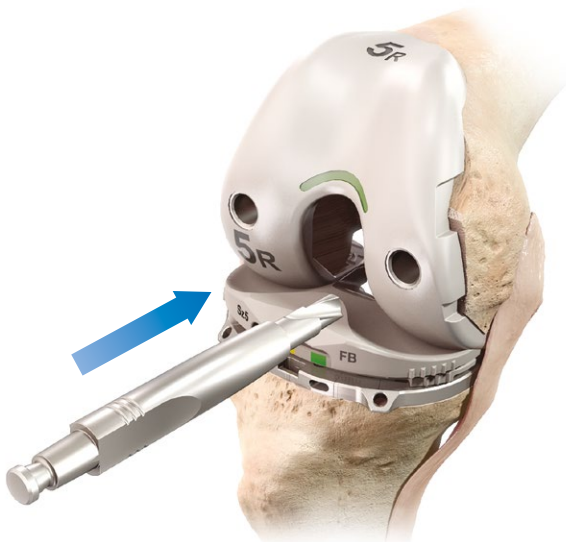
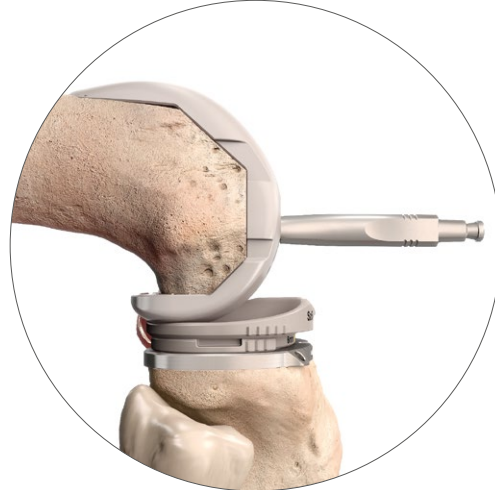

CAUTION

If the surgeon is not satisfied with alignment or tracking of the Medialized Anatomic Patella Trial after drilling the peg holes, it is recommended to use a Medialized Dome Patella. The patella peg hole preparation is identical for the Medialized Dome Patella and the Medialized Anatomic Patella.

Tibial Base Implantation

Cementing Technique



During cementing of implants, movement of the components should be minimized while the cement is curing.

Prepare the sclerotic bone to ensure a continuous cement mantle with good cement interdigitation of 2 mm - 4 mm. This can be done by drilling holes and cleansing the bone with pulsatile lavage, taking care to dry the bone afterwards. Pack residual small cavity bone defects with cancellous autograft, allograft, or synthetic bone substitutes.



Apply a thick layer of cement to the bone, the implant surface or to both.

Cement should be applied to the cleaned and dried prepared tibial plateau. Also, it is critical to ensure that cement fully surrounds the cone of the tibial base implant.



CAUTION

Blood lamination can reduce the mechanical properties of the cement; therefore, it is vital to choose cement that reaches its working phase quickly. If applying cement to both the implant and bone, implantation should be completed early in its dough state to ensure good cement-cement adhesion and reduce the risk of dry laminations; which can weaken the cement.



CAUTION

Application of the cement to the roughened implant surface early in the dough state has been demonstrated to increase the fixation strength of the cement to the implant.²

Tibial Base Implantation



Carefully insert the Tibial Base, avoiding malrotation using the ATTUNE System Impactor.



ATTUNE System Impactor



Per the illustration above, the tibial base implant should be directly impacted to the bone prior to mating with the polyethylene tibial insert as shown in the Tibial Insert Implantation section (page 68). The polyethylene tibial insert should not be attached to the tibial base prior to tibial base implantation. With the Tibial Base inserted, impact it with several blows from the Mallet to the top of the ATTUNE System Impactor in order to pressurize the cement. Then use a Curette to remove all extruded cement.



CAUTION

To prevent damage to the bearing surface, do not remove the Base Protector before impacting the base. Care must be taken not to pull cement from under the edge of the implant in order to ensure the edges remain sealed.

Femoral Component Implantation

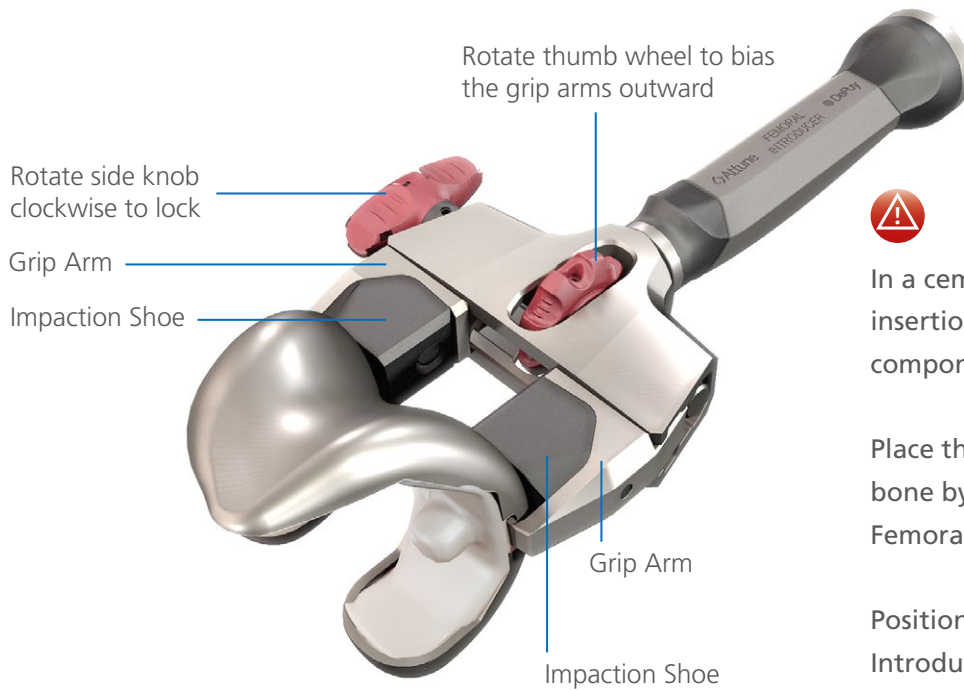

In a cemented application, before insertion, place cement onto the femoral component and the femur.

Place the femoral component onto the bone by hand or, if preferred, use the Femoral Introducer.

Position the femoral component on the Introducer by rotating the red Central Thumb Wheel on the Introducer to move the Grip Arms outward. Then push the femoral component against the impaction shoes, and rotate the Central Thumb Wheel to move the Grip Arms inward so that the arms engage in the slots on the femoral component. Rotate the Side Knob clockwise to lock and secure the implant.

Begin inserting the femoral component by engaging the Femoral Lugs in the lug holes of the distal femur, and deliver several Mallet blows to the Introducer.

To release the Femoral Introducer, rotate the Side Knob counterclockwise and rotate the red Central Thumb Wheel to move the Grip Arms outward.



CAUTION

Application of the cement to the roughened implant surface early in the dough state has been demonstrated to increase the fixation strength of the cement to the implant.²

Femoral Component Implantation

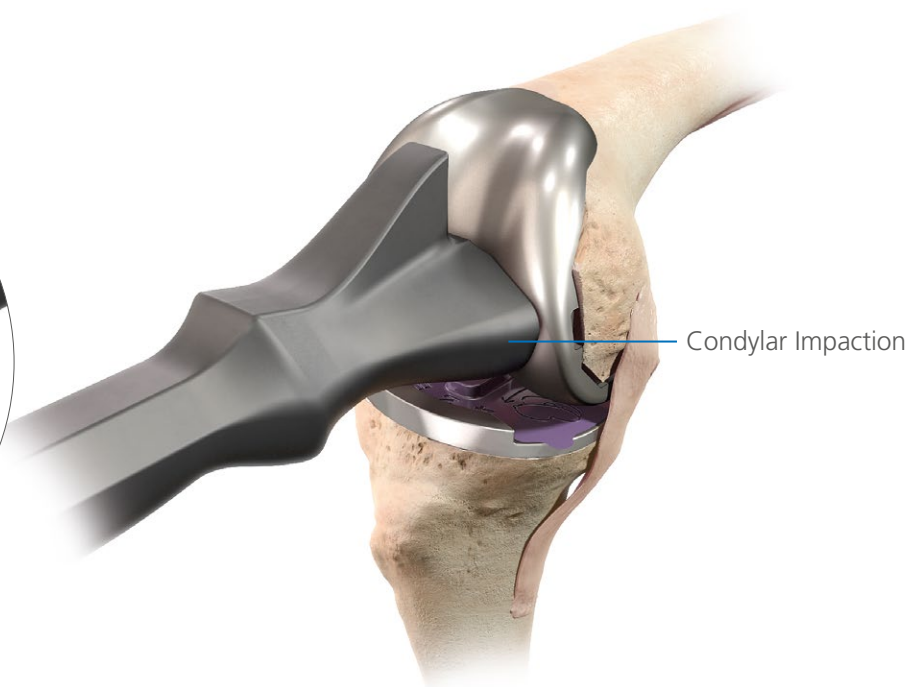

For final femoral component impaction use the ATTUNE System Impactor.

Use a combination of condylar and notch impaction to seat the femoral component. Then use a Curette to remove all extruded cement.

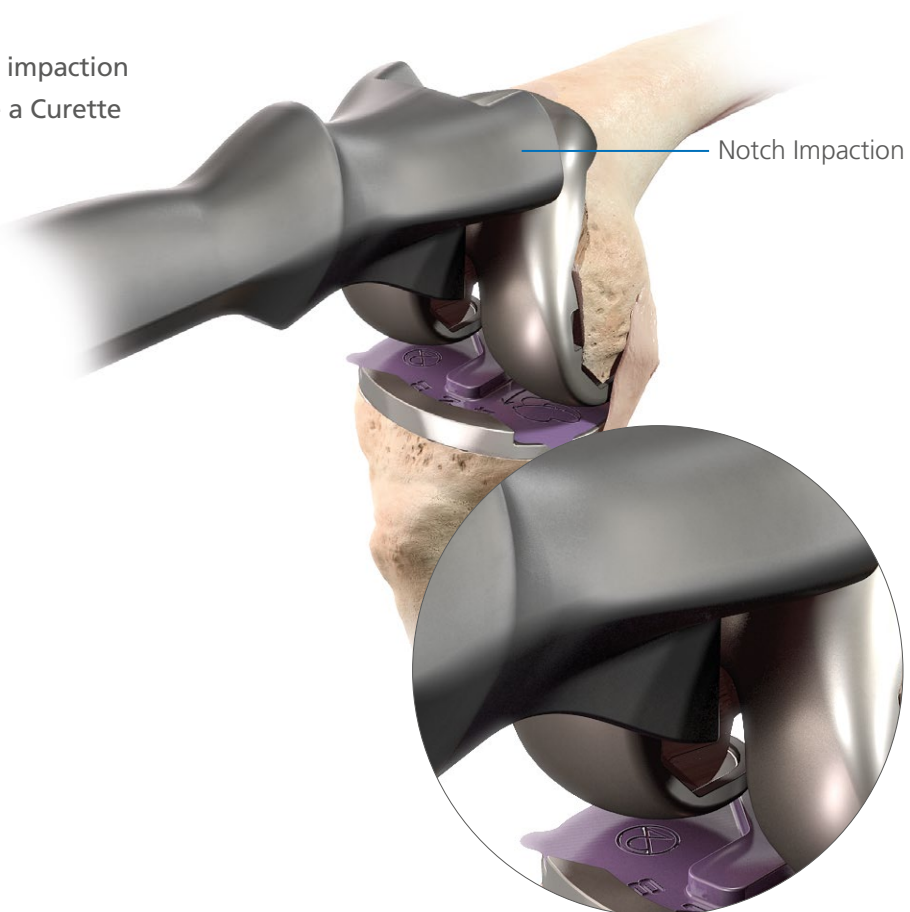

Femoral Component Implantation

Tibial Trial Extraction

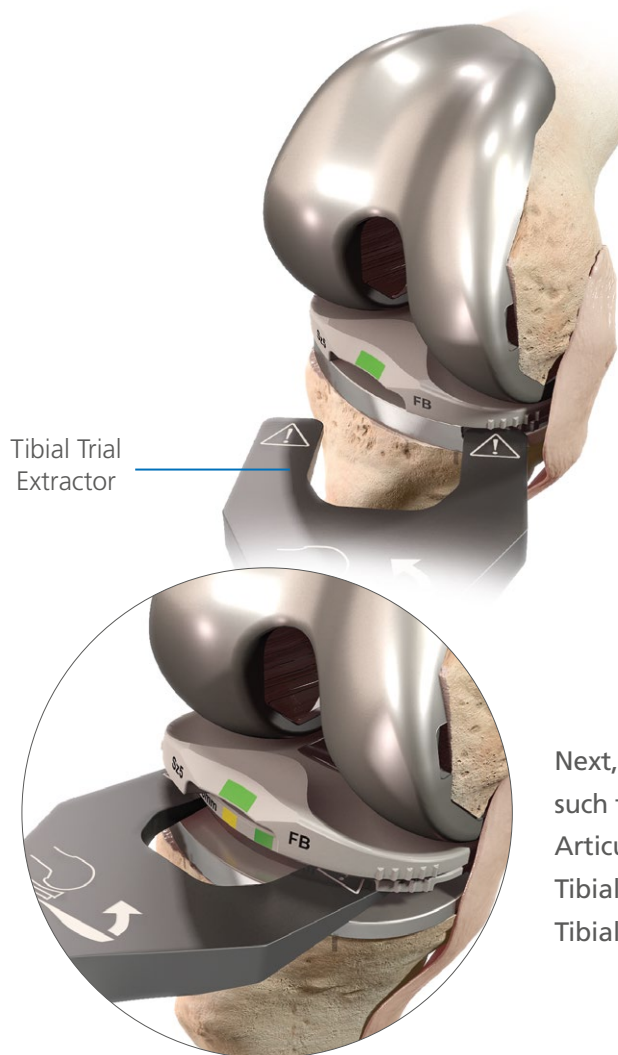

The Tibial Trial Extractor is designed to aid in the removal of insert trials. The instrument can be used with the Tibial Base Implant as well as with the Tibial Base Trials.

With the knee in flexion, the surgeon inserts the Tibial Trial Extractor first on the medial side, underneath the Shim and Articulation Surface construct. After inserting one side of the Tibial Trial Extractor, the surgeon then levers up the Insert Trial.

Next, the surgeon pivots the Tibial Trial Extractor such that both ends are underneath the Shim and Articulation Surface construct, followed by pushing the Tibial Trial Extractor into the joint and underneath the Tibial Insert Trials as far as possible.

The surgeon then should lift the handle of the Tibial Trial Extractor **UPWARDS**. This upward movement works with the geometry of the condyles to aid in removal of the Tibial Insert Trials.



Tibial Insert Implantation

A trial reduction may be performed using Insert Trials.

Rotating Platform

For a Rotating Platform implant, place the RP Trial Post into the implanted base component. Then place the Insert Trial over the post and perform the trial reduction. For Rotating Platform components, verify rotational stability with PCL tension. Remove loose fragments or particulates from the Final Tibial Base.

For Rotating Platform tibial components, insert the final Tibial Insert.



Once cement is cured, the trials can be used to verify stability throughout the range of motion. Refer to page 48 (Soft Tissue Considerations for CR Application).

Fixed Bearing

For Fixed Bearing components, place the Insert Trial on the Tibial Base. Verify that the Insert Trial does not tilt up off the front of the base during the range of motion test. This could indicate that the PCL is too tight. Remove loose fragments or particulates from the Final Tibial Base.



For Fixed Bearing tibial components, angle the Tibial Insert posteriorly and slide the posterior tabs into the posterior undercuts of the Tibial Base.



Tibial Insert Implantation

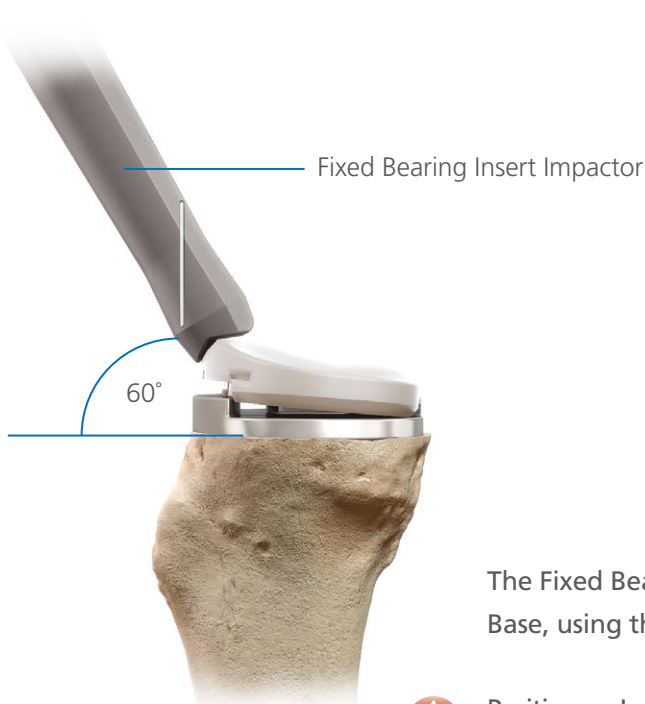

The Fixed Bearing Tibial Insert is impacted into place on the Tibial Base, using the Fixed Bearing Insert Impactor.



Position an Impactor at approximately 60 degrees on the insert so that the notch rests on the anterior edge of the center of the insert. Use a Mallet to strike the Fixed Bearing Insert Impactor. Confirm seating by circumferential inspection. Move the leg into extension, and then lift the leg back into flexion for final removal of excess cement.



CAUTION

Care should be taken when flexing the knee past 45 degrees to avoid putting force on the posterior aspect of the tibial base while the cement is curing.

Once all components are implanted, extending the leg will further pressurize the cement. The leg should then remain in extension until the cement hardens for the appropriate time depending on the cement type used.

Final Patella Preparation



Connect the Patella Clamp Button Holder to the Patella Drill Clamp.

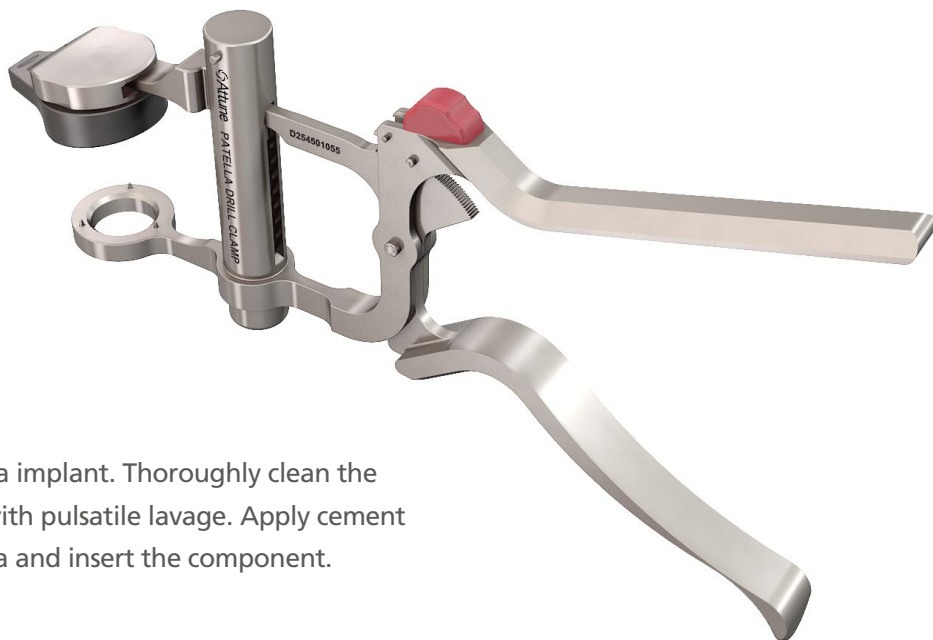

Apply cement to the patella implant. Thoroughly clean the cut surface of the patella with pulsatile lavage. Apply cement to the surface of the patella and insert the component.

Patella Component Implantation

The Medialized Dome or Medialized Anatomic Patella Buttons are designed to fully seat and stabilize the implant as the cement polymerizes.

Center the Medialized Dome or Medialized Anatomic Patella Button and Button Holder Assembly over the articular surface of the implant and the metal backing plate against the anterior cortex of the patella, avoiding skin entrapment.

Engage the Patella Drill Clamp to firmly hold the Patella Implant until polymerization is complete. Remove all extruded cement with a Curette.

Release the Patella Drill Clamp by unlocking the Locking-Switch on the handle and slightly squeezing the Patella Drill Clamp Handles to disengage the locking mechanism.



Reduce the patella.

Final Medialized Dome Patella

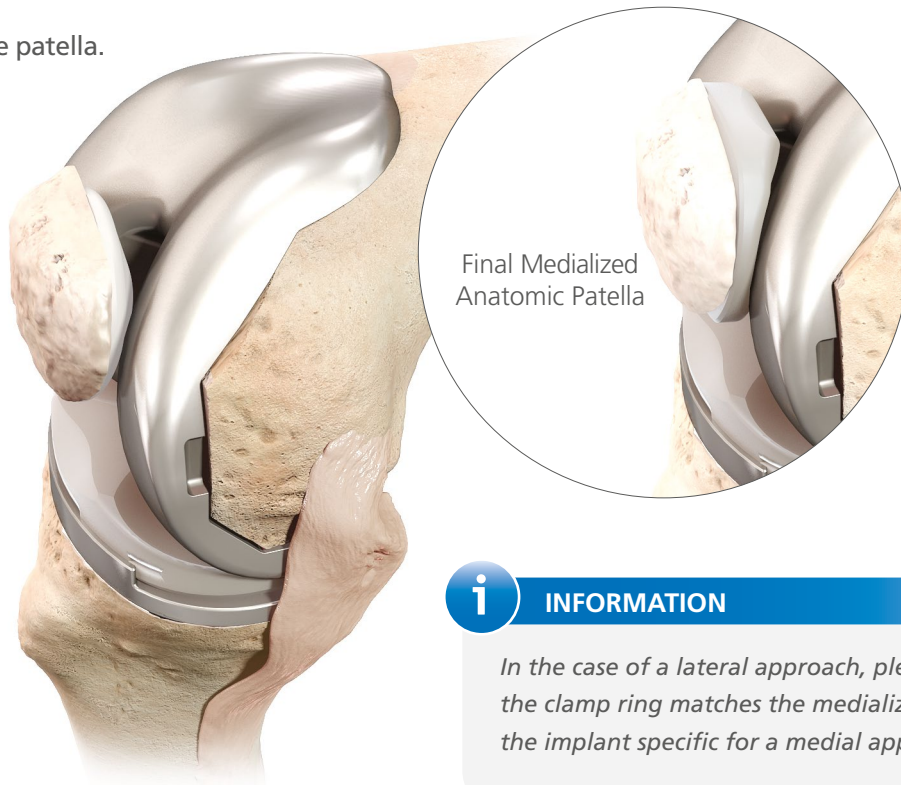

i INFORMATION

In the case of a lateral approach, please consider that the clamp ring matches the medialized geometry of the implant specific for a medial approach.

Closure



Close the knee in layers using the surgeon's preferred technique.

Appendix 1: Optional Patella Drilling Technique



Mark the apex of native patella. In most cases duplication of the median crest is recommended.



INFORMATION

Prior to resecting the patella a small hole can be drilled through the apex of the native patella bone (1 - 2 mm deeper than the intended amount of resection). Once the patella has been resected the remainder of the hole will be present on the resected bone surface.

The Drill Trial has a small hole through the center of the apex, representing the peak of the patella implant. This hole can be visually aligned with the pre-drilled hole on the resected patella surface to aid in anatomic placement of the trial.

Appendix 2: Optional Minimally Invasive (MI) Instrument Technique

Overview of the ATTUNE Knee MI Instruments

This appendix highlights the key differences between the standard and MI instruments. The standard ATTUNE Knee INTUITION Instruments are pictured in blue for comparison to the ATTUNE Knee MI Instruments.

Minimally Invasive (MI) Stylus

The MI Stylus has a side loading point in the anterior aspect allowing surgeons to introduce the Sizer body first and then assemble the Stylus. This feature also allows for easy removal of the device.

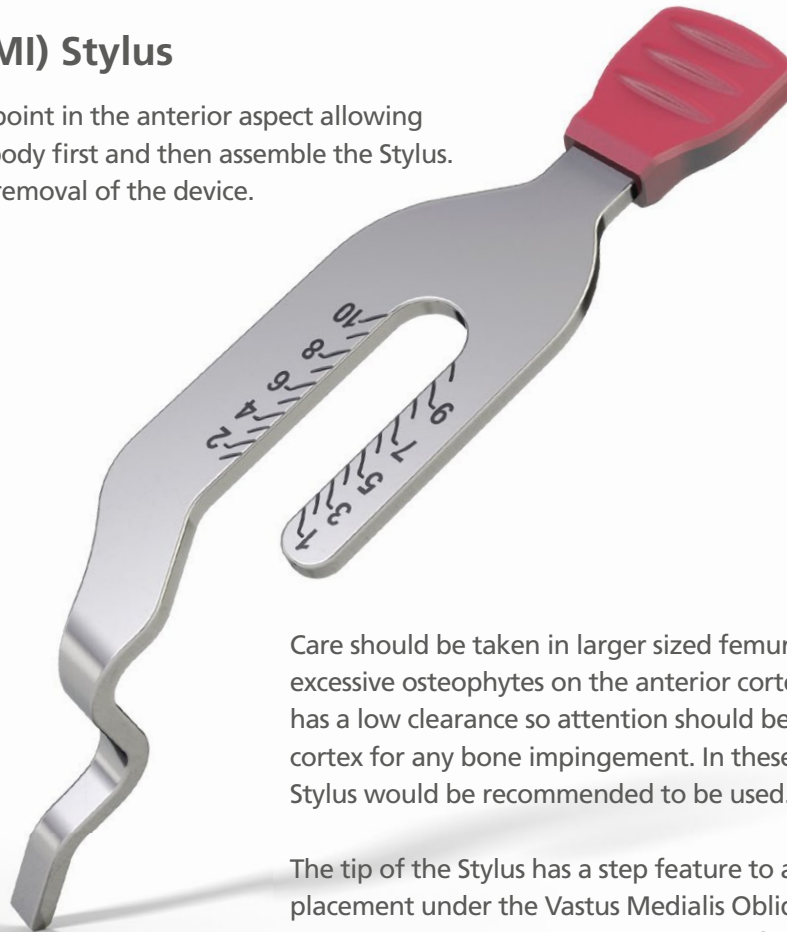

Care should be taken in larger sized femurs or femurs with excessive osteophytes on the anterior cortex. The step feature has a low clearance so attention should be paid to the anterior cortex for any bone impingement. In these cases, the standard Stylus would be recommended to be used.

The tip of the Stylus has a step feature to allow for easy placement under the Vastus Medialis Obliquus (VMO) for small incisions. The height and length of the Stylus remain the same as the standard Stylus.

To assemble, the short arm on the left hand side should be placed underneath the lowest collar which will sit flush against the base allowing for the Stylus to be pushed forward.

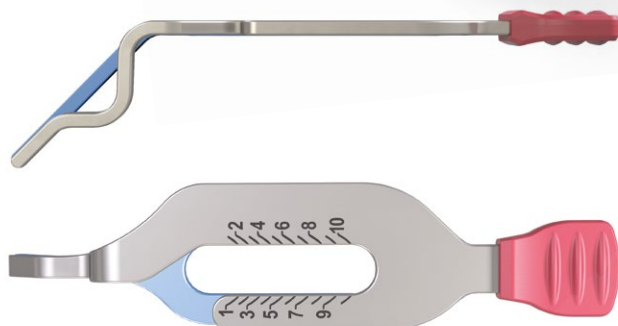

ATTUNE Knee INTUITION Standard Instrument size comparison

Appendix 2: Optional Minimally Invasive Instrument Technique

MI Distal Femur Cutting Block

The MI Distal Femur Cutting Block is smaller by 12 mm in the M/L (medial/lateral) and 6 mm in the A/P (anterior/posterior) dimension as compared to the standard Distal Femur Cutting Block. The clusters of 3 pin holes are 2 mm closer in M/L and therefore, these two Blocks are not interchangeable.

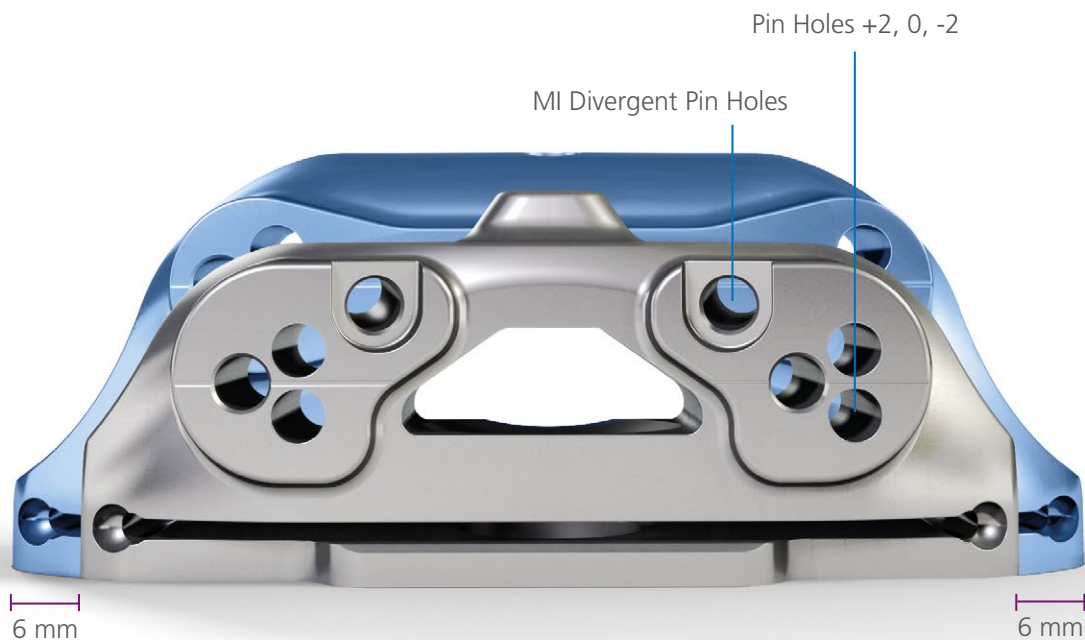

Divergent pin holes are located above and inside the cluster of 3 pin holes.

Note that due to the close proximity of the holes, the Pin Jack head may interfere with the pins.



SIGMA[®] HP Knee System MI Angel Wing

The main features of the MI Angel Wing include a reduced length by 20 mm and a geometric profile for ease of use including an increased width and angle of curvature.

Appendix 2: Optional Minimally Invasive Instrument Technique

MI Tibial Drill Tower

The height is the same for both towers allowing for the same Drill to be used as well as the Drill Stops. The M/L width has been reduced by 9 mm (matching the width of the Size 1 Tibial Tray) as compared to the standard INTUITION Tibial Drill Tower and the posterior wall thickness has also been reduced by 1.5 mm. **The MI Tibial Drill Tower accepts sizes 1-5 Keel Punches only.**



ATTUNE Knee MI Spacer Block ATTUNE Knee MI Spacer Base ATTUNE Knee MI CR Flexion Base

The MI Spacer Block has an offset handle to allow surgeons to avoid patella tendon impingement and allow better access to the joint space. With the offset handle, this device allows for medial or lateral access. The overall length has been reduced by 18 mm.

The MI Spacer Block should be used with Shim sizes 3-4. The material is stainless steel to maintain rigid properties. There are two holes to accept the Alignment Rod. Both ends are modular unlike the standard Spacer Blocks allowing for more flexibility. One base for CR Extension/PS Flexion Extension and one base for CR Flexion is available.

Appendix 2: Optional Minimally Invasive Instrument Technique

SIGMA HP Knee System 0 Degree Left/Right MI Tibial Cutting Blocks

The block geometry has been optimized to complete cuts while avoiding patella impingement.

The Cutting Blocks contain a convergent pin hole to prevent lift off during cutting and an anatomic reference line to ensure correct alignment on the tibial tubercle.

The Cutting Blocks can be used with an extra medullary (EM) approach, have ± 2 mm adjustability, and a vertical pin slot to lock down the Varus/Valgus angle.

It is important to note that the pin holes on these Blocks are different than the other INTUITION Instruments and SIGMA® HP Knee System Tibial Blocks. The pin holes on the MI Tibial Cutting Blocks are positioned more medially and perpendicular to the angled tibial bone surface (see Image 2 below). This medialization allows the Block to be used in very small incisions.

In Image 1, the Alignment Handle and Alignment Rod can be used for alignment. However, because of the medial orientation of the MI Cutting Block in Image 2, the Alignment Handle and Alignment Rod cannot be used in conjunction with this Block.

When assessing alignment with the MI Cutting Blocks, the medial third of the tibial tubercle should be referenced using the line on top of the Block. This, along with the alignment features on the Tibial Jig, will provide the necessary points of reference to precisely align the Block.

It is also important to remember that the MI Tibial Cutting Blocks will not work with the SIGMA HP Knee System IM Tibia Jig nor the SIGMA HP Knee System Spiked Uprod. The reason for this is due to the position of the lateral pin holes. The lateral pin holes will be covered up by the HP Spiked Uprod and HP IM Tibial Jig assembly, making pinning impossible on the lateral side.

Lastly, when pinning the MI Tibial Cutting Blocks in place, the medial pin should be inserted first and the lateral pin second. If a pin was placed in the vertical slot, it should be removed before inserting the lateral pin.

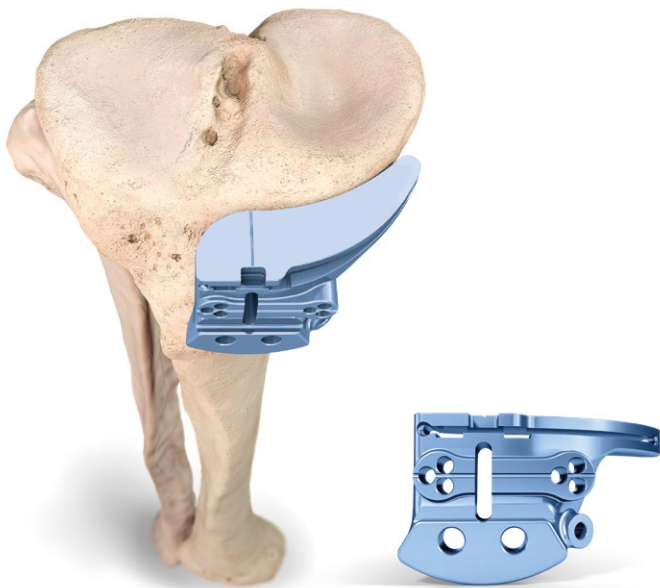

Image 1
ATTUNE Knee Standard Block



Image 2
SIGMA HP Knee System MI Block

■ ATTUNE Knee INTUITION Standard Instrument size comparison

Appendix 3: Optional Lamina Spreader Technique

The following technique describes the use of Lamina Spreaders to assess soft tissue balance, femoral sizing, and setting femoral rotation using the ATTUNE Knee System INTUITION Instruments.

Extension Space Balancing

After the distal femoral and proximal tibia resections are made, consider removing prominent osteophytes, particularly medial and lateral osteophytes, as they can affect soft tissue balancing. Use the Spacer Block or Lamina Spreaders medially and laterally to assess a rectangular gap in extension. The Spacer Block can be used to determine the appropriate thickness of the tibial insert in extension. Introduce the Alignment Rod through the Spacer Block in order to assess alignment.

If the alignment is correct and medial or lateral tightness remains after removal of osteophytes, selective releases can be performed at this time if the surgeon chooses.

Flexion Space Balancing

Lamina Spreaders may be used with the knee flexed to 90 degrees to set the femoral rotation in flexion.

Lamina Spreader

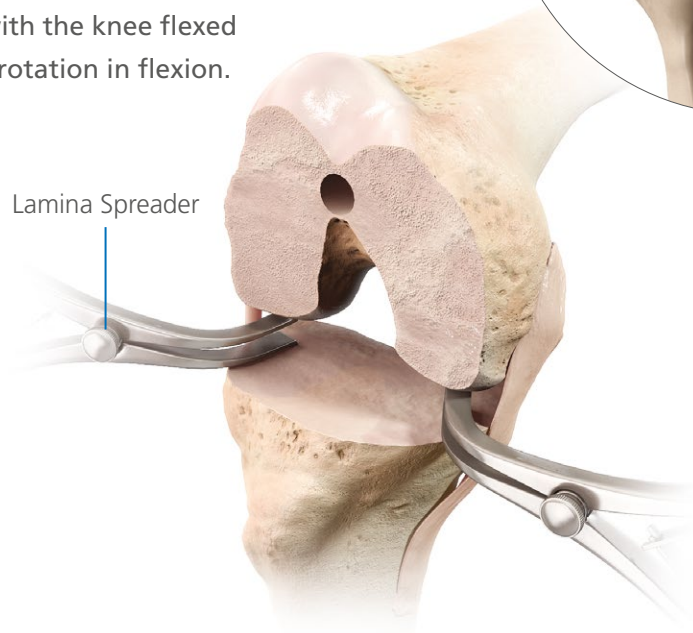

Appendix 3: Optional Lamina Spreader Technique

Marking the Bone

There are three ways to mark the femur to orient the femoral rotation.

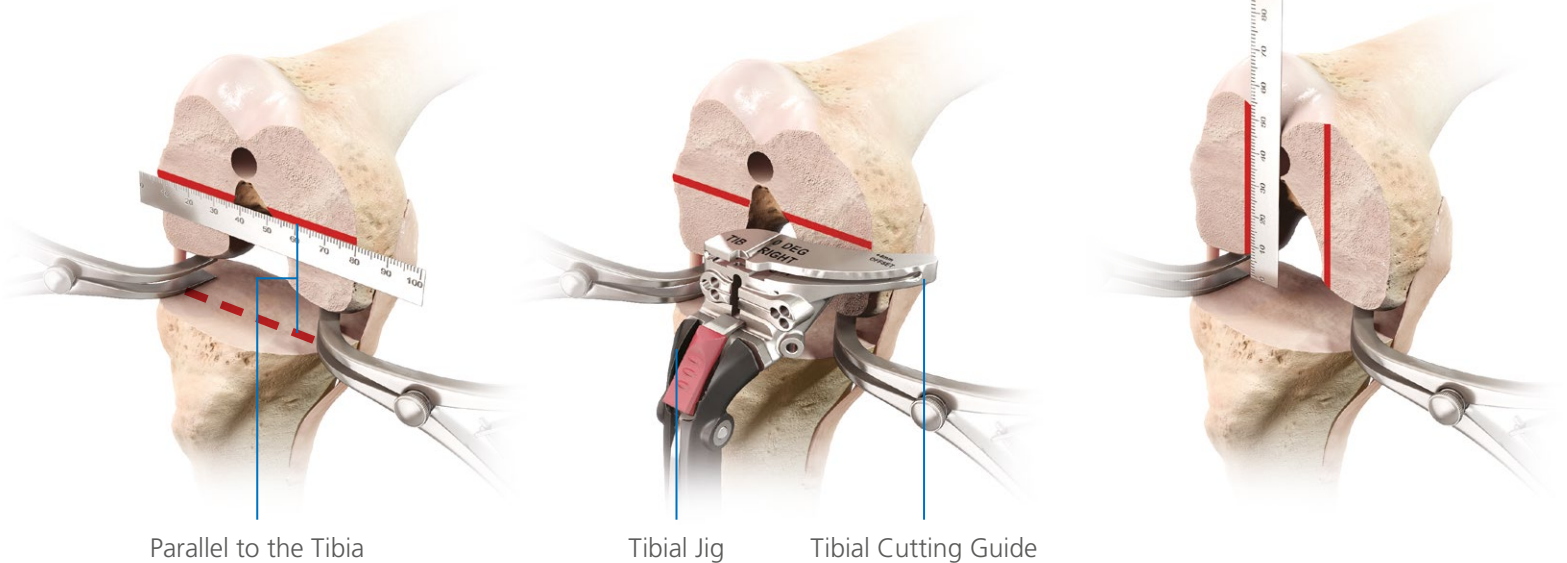

Option 1:

With appropriate tension placed on the medial and lateral soft tissues, a transverse line that is parallel to the tibia can be marked across the distal femur a fixed distance from the resected tibial surface by using the edge of an Osteotome or a General Medical Ruler.

Option 2:

The Tibial Cutting Guide can be extended to reach the resected femoral bone surface as a guide to mark a line parallel to the tibial resection surface.

Option 3:

A perpendicular line can be drawn from the resected tibial surface by using the edge of an Osteotome or a General Medical Ruler.

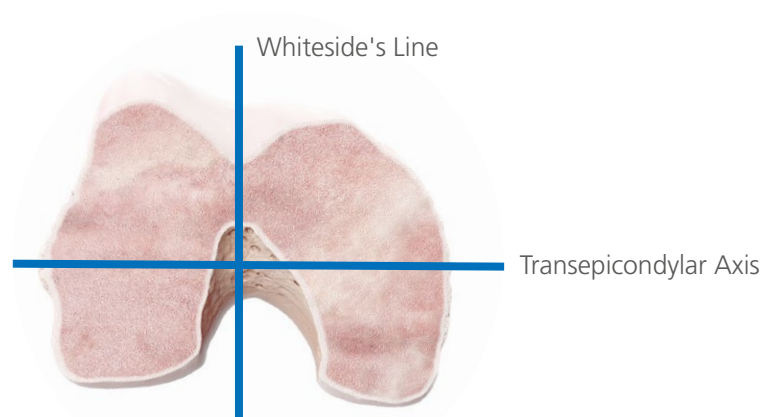

As a secondary check, these lines can be compared against key anatomical landmarks to avoid malrotation of the femoral component.

Appendix 3: Optional Lamina Spreader Technique

Placing the Measured Sizer

The Measured Sizing and Rotation Guide is then placed on the distal femur. The Measured Sizer allows placement in 0, 3, 5, or 7 degrees of external femoral rotation based on the posterior femoral condyles and can be adjusted on the bone.

Dependent on the method chosen to mark the femur, the Sizer can now be rotated so that the horizontal (the white line between the posterior reference holes) or vertical (the metal Uprod) lines on the Measured Sizer are parallel to the horizontal or vertical lines previously drawn on the femur.

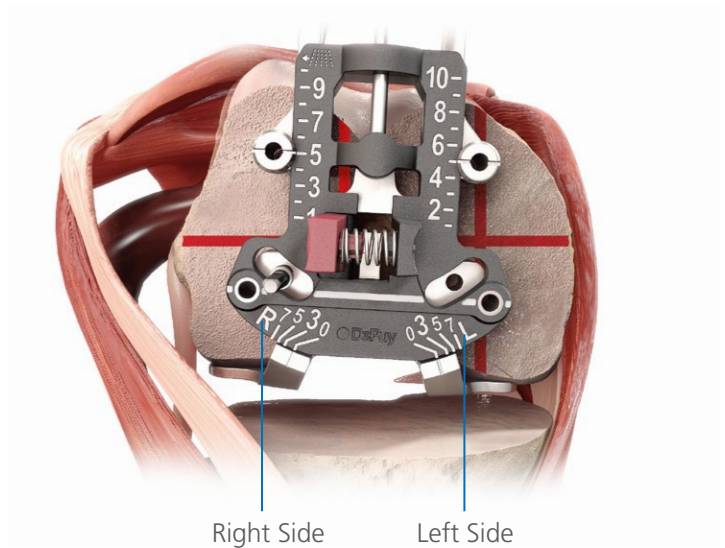

Squeeze the lever and simultaneously rotate

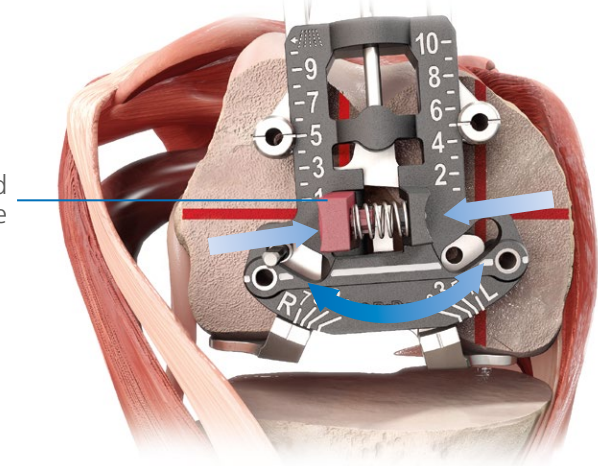

Setting Rotation

Adjust the degree of external rotation by squeezing the Femoral Rotation Lever and rotating the anterior section while holding the feet of the device against the posterior condyles.

Checks for excessive rotation can be made against Whiteside's line, the transepicondylar axis or the rotation markings on the Measured Sizer.

Size the femur and insert the pins according to the technique described in the main body of this surgical technique.

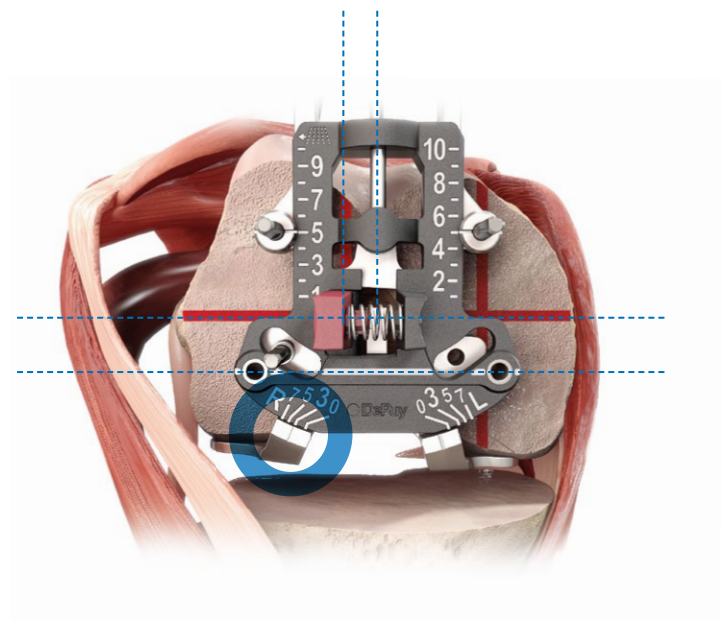

Appendix 4: ATTUNE Tibial Insert Trials and Trial Handle

The ATTUNE Tibial Insert Trials and the ATTUNE Trial Handle shall be used in conjunction with the INTUITION Instruments surgical technique for trial reduction while implanting an ATTUNE Knee.

It is the surgeon's choice to use the modular or one-piece insert trials. ATTUNE Tibial Insert Trial variations are shown below.



PS Rotating Platform



CR Rotating Platform



PS Fixed Bearing



CR Fixed Bearing

The **ATTUNE Tibial Insert Trials** are a solid construct and will indicate the equivalent size and thickness of the Tibial Insert Implant.

The **ATTUNE Trial Handle** is an instrument that is designed to work with the ATTUNE Tibial Insert Trials in the trial reduction.



Select the ATTUNE Tibial Insert Trial that matches the femoral size and style (CR or PS for either Rotating Platform or Fixed Bearing), and the appropriate thickness (5 mm, 6 mm, 7 mm, 8 mm, 10 mm, 12 mm, 14 mm and 16 mm for CR and PS, and in addition 18 mm for PS, for core sizes 3 - 8).

Articulation Surface Indicators	
Fixed Bearing	<input type="checkbox"/>
Rotating Platform	<input type="radio"/>

i INFORMATION

Continue with trialing and the remainder of the surgical work-flow as described in the main body of this surgical technique.

Appendix 5: Revision Fixed Bearing (FB) Tibial Base

The following technique describes the use of the ATTUNE Revision Fixed Bearing (FB) Tibial Base, alone or with a 50 mm Cemented Stem following the Extramedullary Tibial Resection described on page 19, for patients who might need supplemental fixation. Pre-operative planning templates are provided for these constructs and should be used to confirm tibial baseplate size/position/slope relative to stem position within the canal.

Tibial Sizing

Attach the Alignment Handle to the appropriate size Revision Tibial Prep Plate based on pre-operative templating and place onto the resected tibial surface. Rotation should be set per surgeon preference. One suggested technique follows:

The rotation of the Tibial Base Trial is typically centered on the junction between the medial and central third of the tibial tubercle. Assess the position of the Base at the proper rotation to maximize tibial coverage while avoiding overhang. Optionally, a mark may be made on the anterior cortex of the tibia for future reference to tibial rotation.

When using Pins, be careful not to deflect the Base position. 

Only utilize Non-Headed Pins through the parallel or angled Pin Hole options on the Prep Plate. Additionally, the Anterior Pin Holes may be utilized with the Low Profile Anterior Pins inserted with the Low Profile Tibial Pin Puller to aid in fixating the Prep Plate. Tibial Prep Plates for Sizes 1 - 3 have an anterior protrusion with an indicated line for the anterior profile of the definitive implant.



Angled Pinning

Parallel Pinning



Anterior Profile

Example of anterior protrusion for Sizes 1 - 3

CAUTION

Care should be taken when seating the Pins so as to not perforate the Tibial Cortex.

INFORMATION

Final Tibial Base Rotation can also be determined during trialing with the Femoral Trial and Revision Tibial Insert Trial in place.

INFORMATION

The Revision Tibial Prep Plates are 6 mm thick and are not reflective of the actual Tibial Base Implant or Tibial Base Trial thicknesses. The Prep Plates should not be utilized to determine definitive Insert thickness.

Appendix 5: Revision Fixed Bearing (FB) Tibial Base

Tibial Preparation

With the Revision Tibial Prep Plate in place, attach the Revision Tibial Prep Tower by inserting the spikes of the Tower through the two inside holes on the anterior aspect of the Plate.



Insert the Revision Cemented Reamer Bushing into the Tower.



The Revision Tibial Cemented Stem Reamer includes markings for the various Short Cemented Stems and Tibial Base construct depths.



INFORMATION

The Tibial Cemented Stem Reamer prepares for a line-to-line fit with the pre-assembled End Cap or the 14 x 50 mm Cemented Stem Implant.

Appendix 5: Revision Fixed Bearing (FB) Tibial Base

Tibial Preparation

Assemble the Modular Stop on the Revision Tibial Cemented Stem Reamer to align with the "FB-0" mark for the Revision Tibial Base alone or the "FB-50" mark when utilizing the 50 mm Cemented Stem. Once assembled, advance the Reamer until the Modular Stop is flush with the top of the Revision Cemented Reamer Bushing.



Modular Stop assembled to the Cemented Stem Reamer at the FB with 50 mm Stem mark

The Cemented Stem Reamer may be utilized through the Reamer Bushing without the Modular Stop. In that application, progress the Reamer until the desired depth line is flush with the proximal feature of the Reamer Bushing.

Remove the Cemented Stem Reamer and Cemented Reamer Bushing.

i **INFORMATION**

If preparing for a Revision FB Tibial Base without a Stem Extension, ream to the "FB-0" mark on the Cemented Stem Reamer to prepare for the End Cap on the Tibial Implant.



Appendix 5: Revision Fixed Bearing (FB) Tibial Base

Tibial Preparation

Assemble the corresponding 50 mm Stem Trial to the end of the Revision Cemented Conical Reamer. If preparing for a Revision Tibial Base without the Stem Extension utilize the Conical Reamer without the Stem Trial.

Assemble the Modular Stop to align with the "FB" line on the Revision Cemented Conical Reamer. 

To prepare for the conical section of the Revision Tibial Base, advance the Conical Reamer through the Revision Prep Tower and seat to the Stop. The Conical Reamer can be used without the Modular Stop. In that application, progress the reamer until the "FB" line on the Reamer is flush with the proximal surface of the Revision Prep Tower. 

With the tibial canal prepared, remove the Tibial Preparation Instruments.



INFORMATION

Do not apply excessive force to the Conical Reamer. If approaching the cortex, stop reaming and consider a slightly different position on the tibial plateau, readjustment of tibial slope and the use of cement to fill any resulting bone voids.



CAUTION

Avoid contacting the sharp edges of the Reamer flutes when attaching the Modular Stop.

Do not reverse ream.

Appendix 5: Revision Fixed Bearing (FB) Tibial Base

Straight Tibial Trial Assembly

Choose the appropriate size of Revision FB Base Trial that corresponds to the Tibial Prep Plate and assemble the Fixed Bearing Stem Adaptor Trial when utilizing the 50 mm stem or assemble the Fixed Bearing Adaptor Trial when a Stem Extension will not be utilized. Either adaptor should be assembled utilizing the temporary snap attachment.



Tighten the construct using the Torque Limiting Screwdriver and System Hex Attachment.

FB Base Trial construct with a 14 x 50 mm Cemented Stem Trial



Assemble the Cemented Stem Trial to the end of the FB Stem Adaptor Trial.



FB Base Trial with FB Adaptor Trial

If preparing for a Revision FB Tibial Base without the Stem Extension, assemble the FB Adaptor Trial to the appropriate FB Base Trial and tighten the construct with the Torque Limiting Screwdriver Assembly.

Seat the Revision Tibial Base Trial construct into the prepared bone.



INFORMATION

DO NOT USE the ATTUNE Impaction Handle with the Revision Tibial Base Trial construct.



INFORMATION

FB Adaptor Trial is utilized when the Revision FB Tibial Base will be implanted without the addition of the Stem Extension.

Appendix 5: Revision Fixed Bearing (FB) Tibial Base

Keel Preparation

Attach the Revision Keel Punch corresponding to the correct tibial size grouping (1 - 2, 3 - 5, 6 - 8, and 9 - 10) to the Revision System Handle or ATTUNE Impaction Handle.



Impact the Revision Keel Punch into the cancellous bone in the correct alignment until the Keel Punch is fully seated with the Revision Tibial Base Trial. Remove the Keel Punch and Handle.

Remove any Pins prior to extracting the Trial Assemblies.



INFORMATION

The Revision Tibial Base Trial will interface with all ATTUNE CR and PS Knee (or System) INTUITION Tibial Insert Trials.

Appendix 5: Revision Fixed Bearing (FB) Tibial Base

Revision FB Tibial Base and 14 x 50 mm Cemented Stem Implant Assembly

i INFORMATION

Note: The protective covering should be retained on the Tibial Base during Assembly and Seating of the Tibial Base.

If utilizing the Revision FB Tibial Base without the 50 mm Cemented Stem, retain the pre-assembled End Cap on the Revision FB Base and proceed to Tibial Base Cementing and Impaction.

Remove the End Cap from the Revision Tibial Base Implant by utilizing the FB End Cap Remover in the Tibial Straight Stem Wrench and rotating the Tibial Straight Stem Wrench **counterclockwise** to unscrew the End Cap.

Thread the 50 mm Cemented Stem Implant into the Tibial Base until hand tight.



Appendix 5: Revision Fixed Bearing (FB) Tibial Base

Revision FB Tibial Base and 14 x 50 mm Cemented Stem Implant Assembly

Assemble the Assembly Wrench Adaptor to the Implant Assembly Wrench with the Stem Wrench facing outwards.

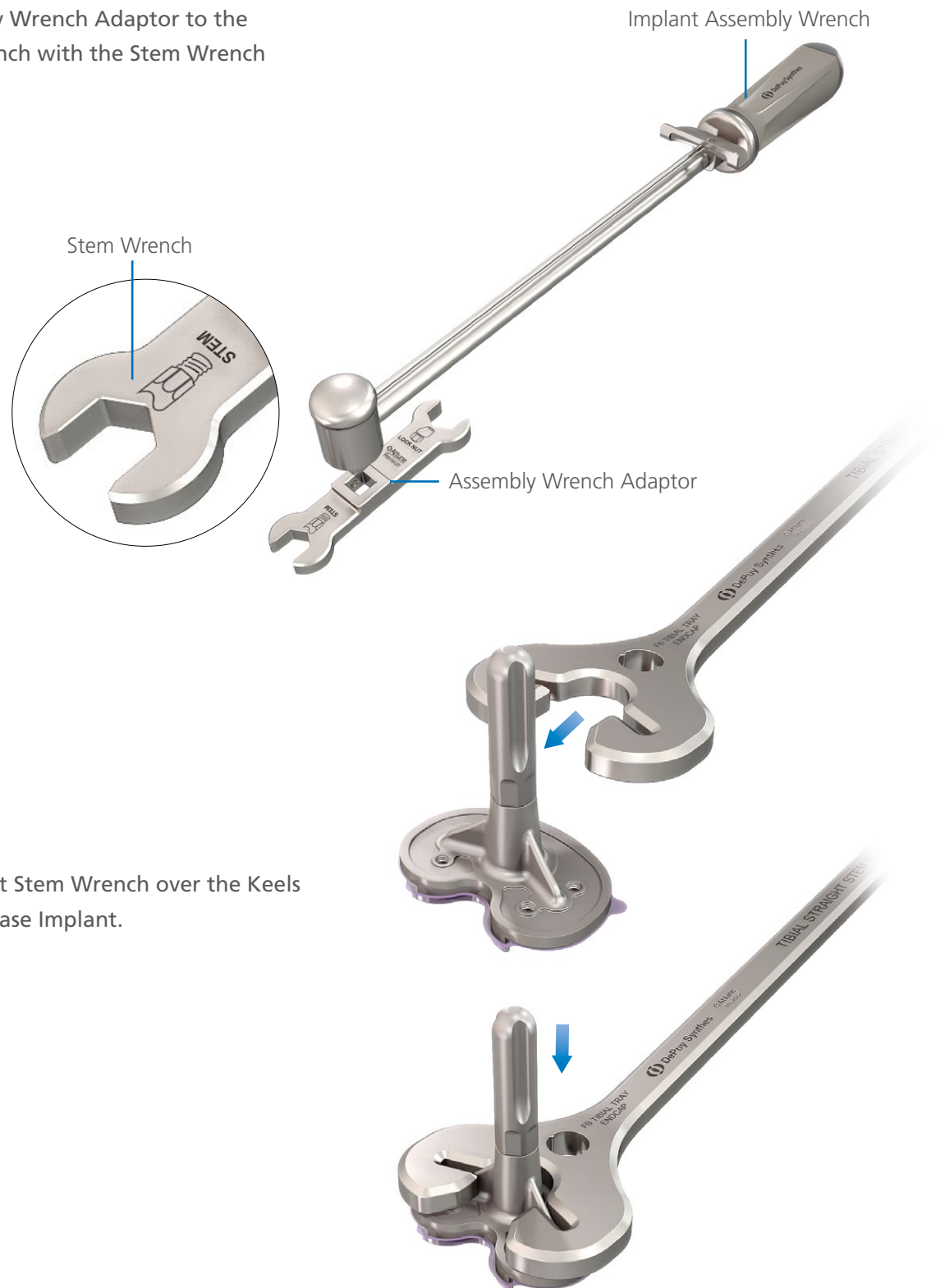

Place the Tibial Straight Stem Wrench over the Keels of the Revision Tibial Base Implant.

Appendix 5: Revision Fixed Bearing (FB) Tibial Base

Revision FB Tibial Base and 14 x 50 mm Cemented Stem Implant Assembly

Hold the **Tibial Straight Stem Wrench** in the left hand, ensuring that the surface of the Tibial Straight Stem Wrench is flush on the Revision Tibial Base.

Hold the **Implant Assembly Wrench** in the right hand and position on the Hex of the Stem that has been threaded onto the Tibial Base, trying to achieve an angle of approximately 90 degrees between the Implant Assembly Wrench and Tibial Straight Stem Wrench. This will make it easier to apply the desired torque.



Gradually bring hands together to rotate the Implant Assembly Wrench until the marker is within the torque range marking. 

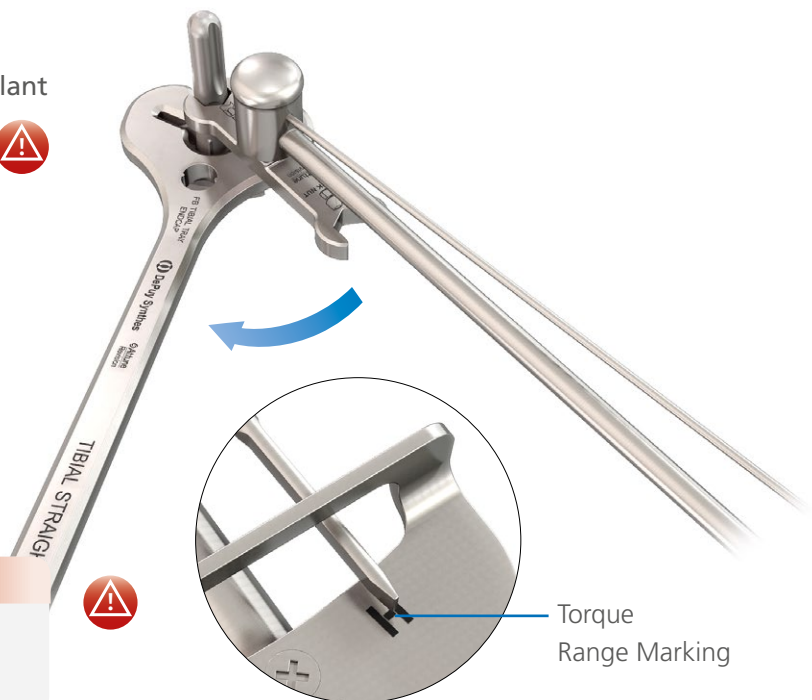
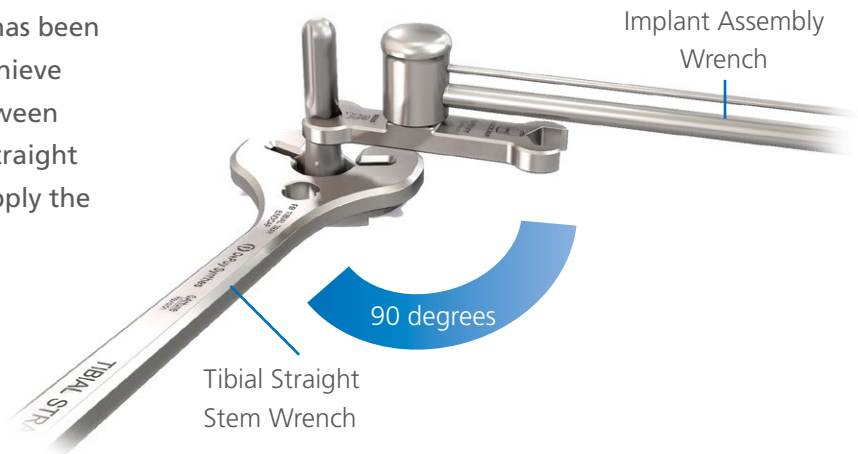

CAUTION

Do not apply so much torque that the marker fully passes the torque range marking.



Appendix 5: Revision Fixed Bearing (FB) Tibial Base

Preparation and Seating the Tibial Construct

Consider the use of a cement restrictor.

Apply a thick layer of cement to the bone, the implant surface or to both.

It is critical to ensure that cement fully surrounds the cone of the Revision FB Tibial Base Implant and the Cemented Stem (if applicable). For additional reference see the Guidance for Cementing Primary Total Knee Replacements document.

Carefully insert the Revision Tibial Base Implant using the ATTUNE System Impactor, avoiding malrotation.

Per the illustration above, the tibial base implant should be directly impacted to the bone prior to mating with the polyethylene tibial insert as shown in the Tibial Insert Implantation section (page 68). The polyethylene tibial insert should not be attached to the tibial base prior to tibial base implantation. Impact to seat the Revision Tibial Base Implant and to pressurize the cement. Then use a Curette to remove all extruded cement.

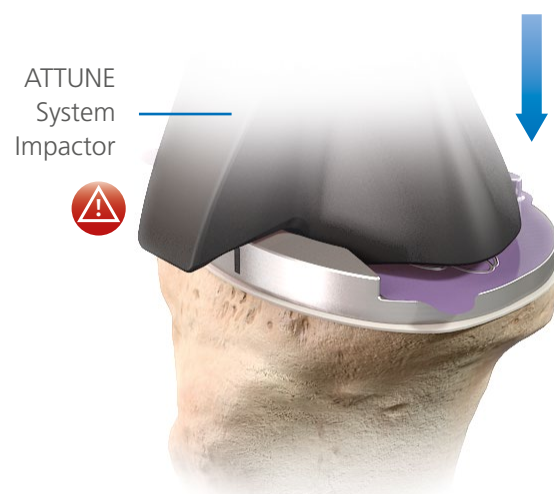
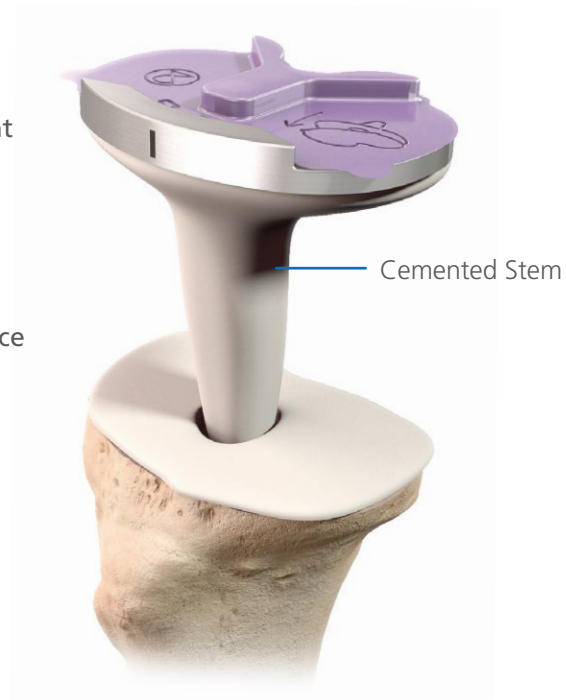

CAUTION

To prevent damage to the bearing surface, do not remove the Base Protector before impacting the Base. Care must be taken not to pull cement from under the edge of the implant in order to ensure the edges remain sealed.

INFORMATION

The ATTUNE Revision FB Tibial Base is compatible with both CR and PS ATTUNE FB Primary Tibial Inserts.

Appendix 6: Optional Balancing Block Technique

The following technique describes the use of the INTUITION Balancing Blocks as an alternative method to assess soft tissue balance in flexion.

Balancing Blocks can be used after proximal tibial resection (as described on pages 14 - 19), Distal Femoral Resection (pages 7 - 13), Femoral Sizing (pages 23 - 28), and Extension Gap Balancing (pages 20 - 21) have been completed.

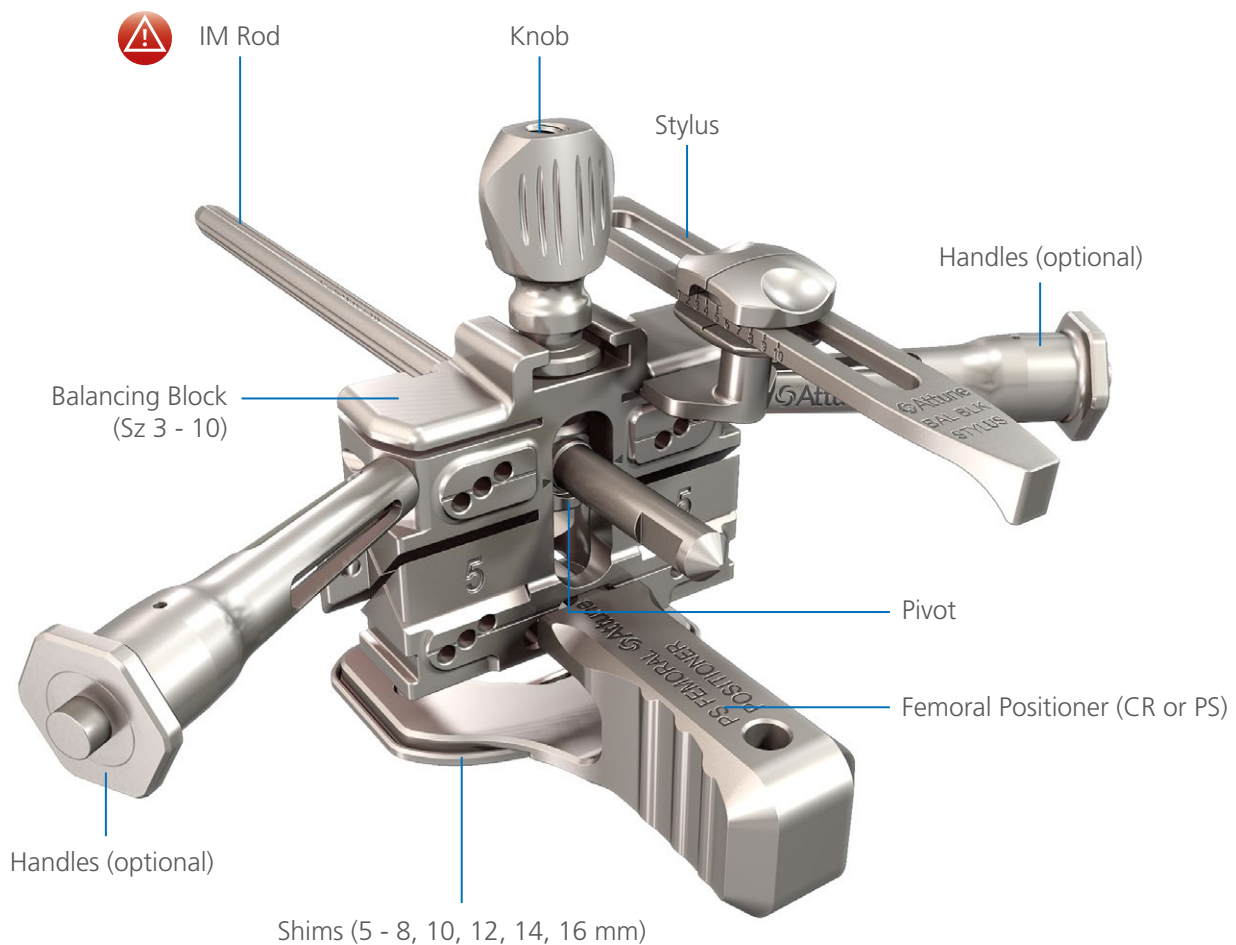

INFORMATION

Additional Shims from the Revision Kit (18 mm and 20 mm) can be used if required.



CAUTION

When drilling the IM hole, ensure that you do not use the stepped portion of the Step Drill.

Appendix 6: Optional Balancing Block Technique

Femoral Positioning and Rotation

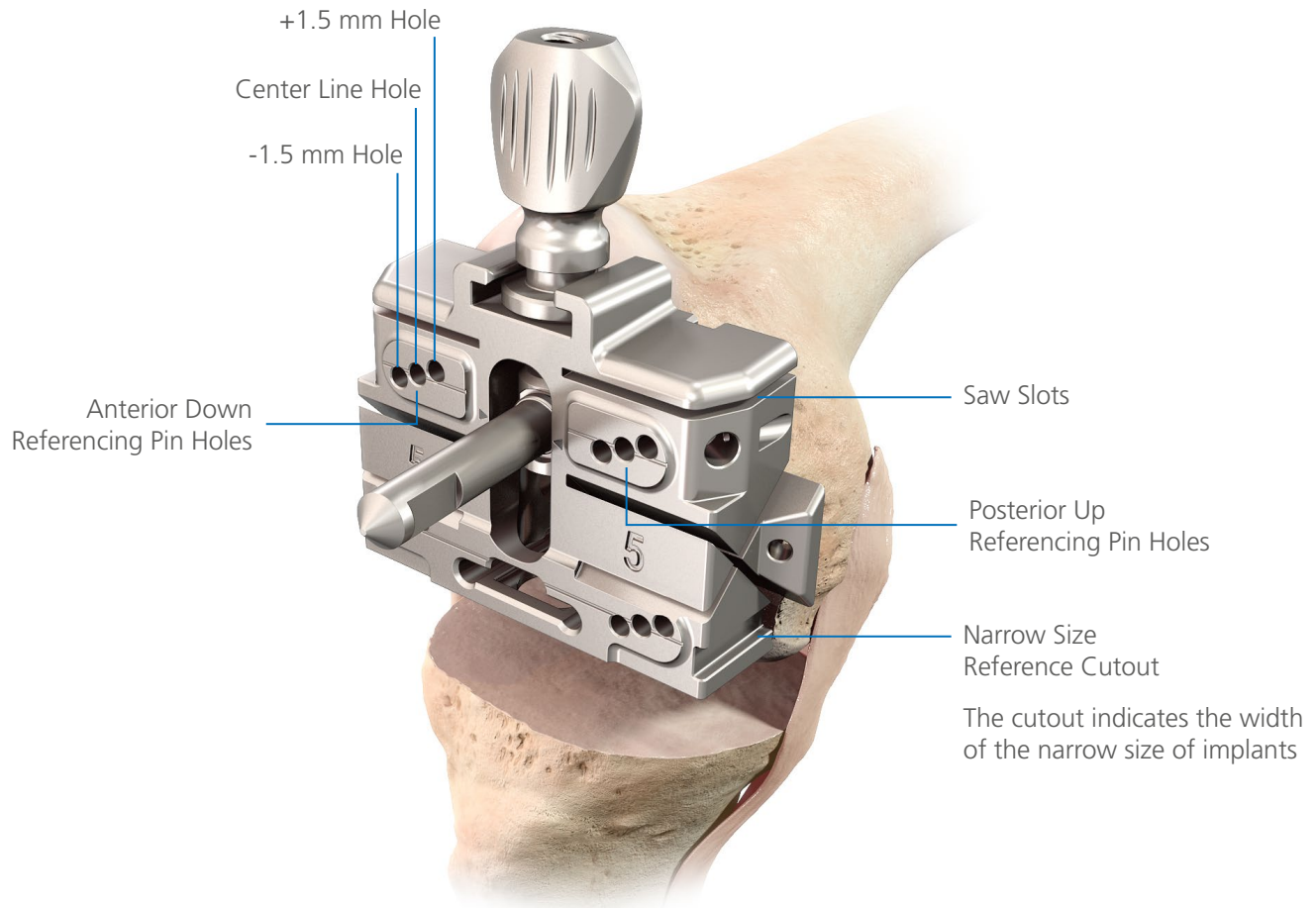

INFORMATION

The ATTUNE Knee System femoral components increase in size by a consistent 3 mm in the A/P direction. The INTUITION A/P Chamfer Blocks allow the surgeon to adjust the A/P position of the femoral component by 1.5 mm in either direction.

This creates the intra-operative flexibility to position the femoral component based on the surgeon's assessment of the flexion gap and the desired posterior condylar offset. See page 102 for more information on gap balancing. If there is no cutout, a narrow component is not available for that size. Narrow components are available for sizes 3, 4, 5 and 6.

Appendix 6: Optional Balancing Block Technique

Balancing Block Assembly

Order of Assembly:

1. Place the Knob between the anterior horns of the Balancing Block. Place hand behind the Knob to prevent it from sliding off the Block.

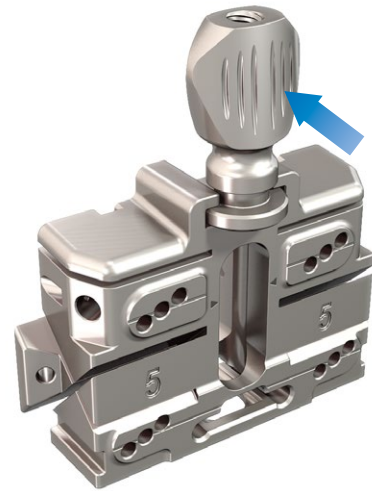

2. Insert the Pivot through the bottom of the Block, tilting the construct slightly to allow the Pivot to slide upwards. Maintain the slightly tilted orientation in order to prevent the Pivot from sliding out of the Block.



3. Insert the IM Rod through the exposed Pivot and turn the Knob clockwise. The IM Rod prevents the Pivot from free-spinning, allowing the Pivot and Knob threads to engage.

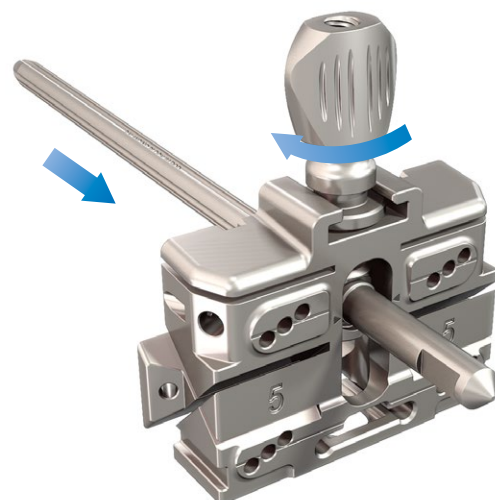

4. Adjust the initial location of the Pivot to the desired height.

Appendix 6: Optional Balancing Block Technique

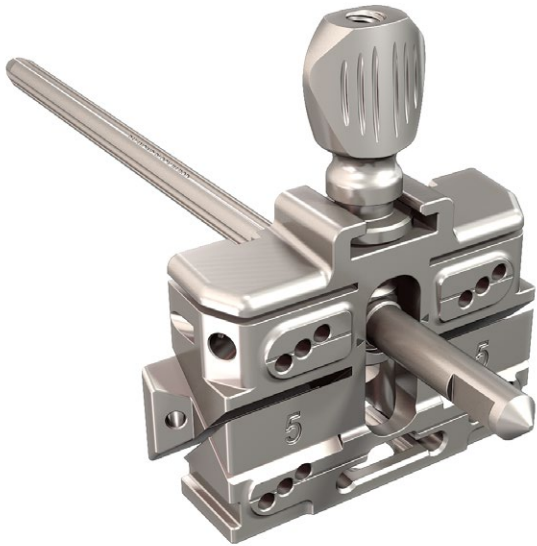

Use the INTUITION Measured Sizer to measure the resected distal femur (as described on page 26), allowing the surgeon to select the appropriate size Balancing Block to load onto the bone.

Select the Balancing Block that matches the femur size indicated by the Measured Sizer. Insert the IM Rod through the Pivot, ensuring placement through the front face. The IM Rod has a collar to prevent it from passing through and into the IM canal.

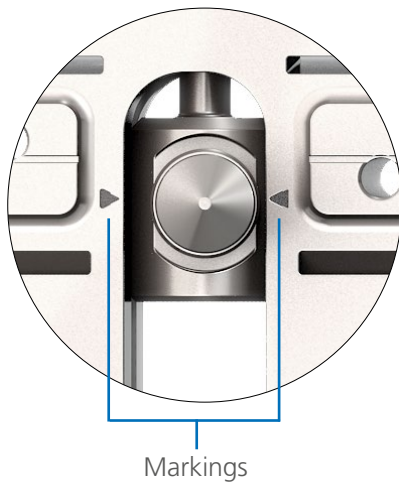

Prior to loading on to the bone, adjust the IM Rod height by rotating the Knob until the IM Rod approximately aligns with the markings on the Balancing Block. This position provides a starting point from which the Block can be adjusted anteriorly or posteriorly by approximately 4.5 mm to achieve the desired ligament tension. Please note that changing the A/P position of the Balancing Block will affect the amount of bone resected.

Appendix 6: Optional Balancing Block Technique

Insert the Block and IM Rod assembly in to the IM canal, ensuring that the Block sits flush with the distal femur. The rotating Pivot provides the ability for the Block to rotate about the IM Rod and seat flush on the distal cut for the selected varus/valgus angle as allowed by the Distal Femoral Jig.

Insert the Stylus through the anterior cutting slot of the Balancing Block, ensuring the Stylus is placed on the lateral side. Slide the Stylus to adjust the superior-inferior position and position it so that it comes into contact with the highest point of the anterior femur. Check that the Stylus indicates the same size of the Balancing Block using the Stylus scale. The position of the Stylus tip will indicate the approximate exit point of the Saw Blade.



INFORMATION

The Stylus has a friction fit to keep it from sliding unintentionally after placed in its desired position.

Also, it is important to note that the Stylus sizing is most accurate when the Stylus foot is positioned straight into the cut slot of the Block and the Stylus arm is positioned straight out, not obliquely.

Appendix 6: Optional Balancing Block Technique

Internal/external rotation is determined with the knee at 90 degrees of flexion so that the posterior surface of the Balancing Block is parallel to the resected tibial plateau. Select the appropriate Shim thickness to match the extension gap and assemble it to the CR or PS Femoral Positioner as appropriate. Introduce the Femoral Positioner and Shim into the joint space, engaging the posterior slot of the Balancing Block.

The knee may need to be slightly flexed or extended until the Femoral Positioner lies flat on the resected tibial surface.

If Lamina Spreaders are preferred, these can be placed and tensioned under the medial and lateral sides of the Balancing Block.

Alternatively, the Spacer Block can be used instead of the Femoral Positioner and placed under the posterior edge of the Balancing Block.

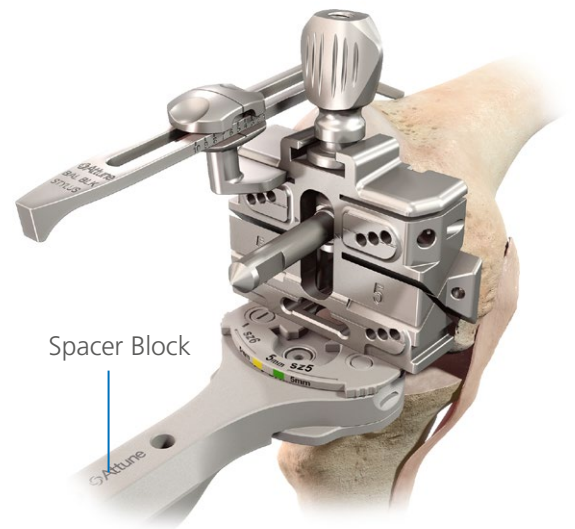
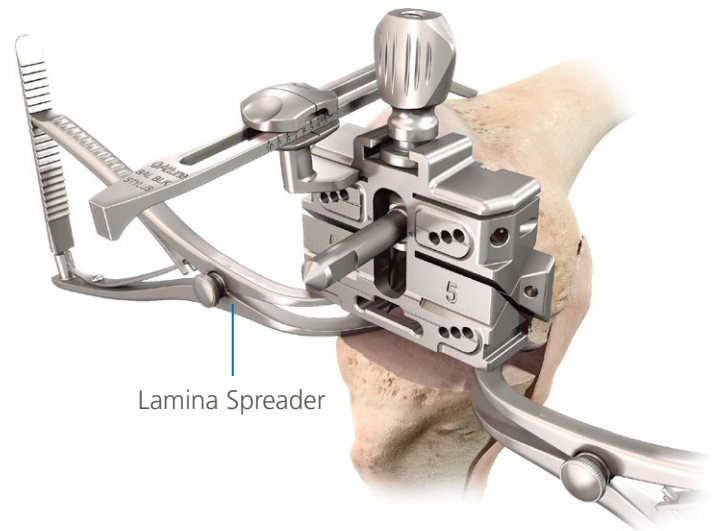

Appendix 6: Optional Balancing Block Technique

Assess the A/P position of the Block after it is loaded onto the distal femur. Anterior position can be assessed either by inserting the Stylus or an Angel Wing through the anterior cutting slot. Posterior resection can be checked visually by observing the placement of the posterior cutting surface relative to the posterior condyles. The Block can also be used at this stage to assess the M/L width of the implant size for both the standard or narrow sizes.



i INFORMATION

When using the anterior offset pin holes, changing the size of the femoral component will alter the posterior femoral condyle resection.

To evaluate femoral size adjustments without altering the posterior femoral cut, place the A/P Chamfer Block onto the anterior Universal Pins and insert two additional pins through the posterior up holes on the Block. Then remove the anterior reference pins. This enables the femoral implant size to be adjusted without altering the flexion gap.

Alternatively, the Block can be moved 1.5 mm up or down (one hole location) to adjust the flexion gap, if necessary.

Appendix 6: Optional Balancing Block Technique

Once the Balancing Block size is finalized, tension and rotation can be assessed. To assess the ligament tension, hold the tibia firmly and stress the leg both in a varus and valgus direction to observe lift off between the Femoral Positioner/Shim and the resected tibial surface. If the ligament tension observed is not as desired, an alternative Shim thickness may be required.

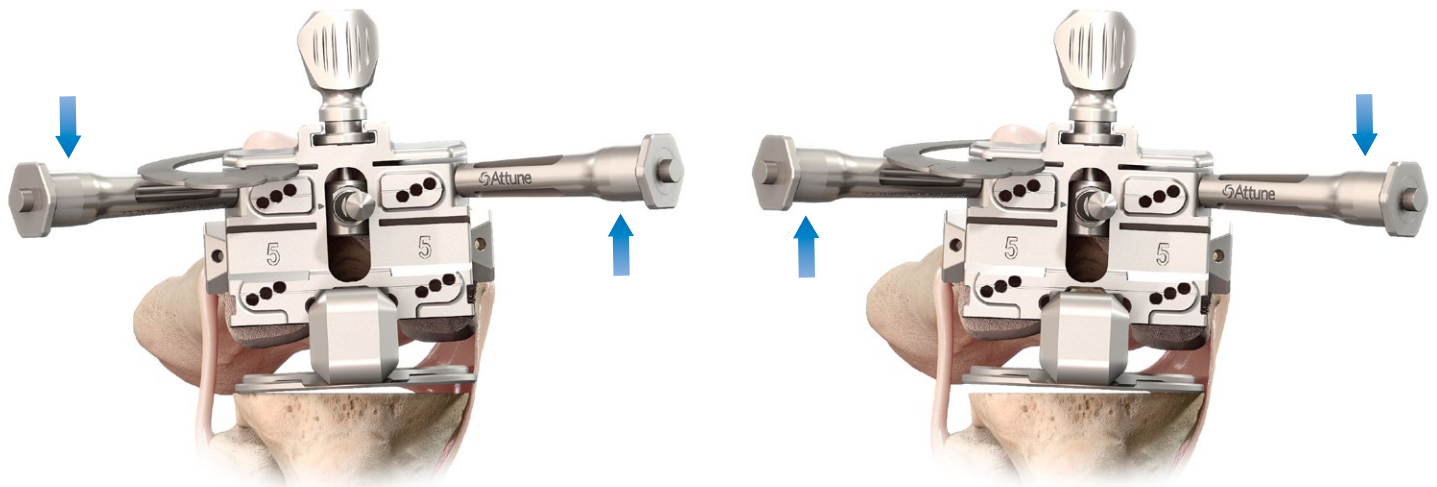

INFORMATION

Alternatively, the optional Handles can be used to stress the Balancing Block medially and laterally to observe lift-off.

Appendix 6: Optional Balancing Block Technique

The knob on top of the Block can be turned clockwise to move the Block posteriorly or put more tension on the collateral ligaments. The knob can be turned counter-clockwise to move the Block anteriorly or put less tension on the collateral ligaments. Please note how this affects the anterior and posterior cut positions relative to the femur. If desired, tibial alignment can also be assessed by inserting the Alignment Rod through the hole in the Femoral Positioner.

Conduct a final check of the anterior resection level with the Angel Wing. All adjustments should be made prior to pinning the Block.

Pin the Balancing Block to the distal femur through either the neutral anterior or posterior pin holes, using Threaded, Non-Headed or Universal Pins.

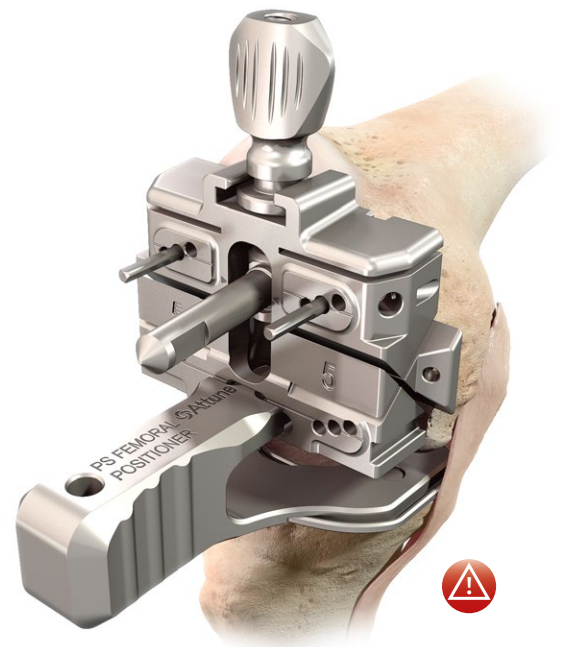
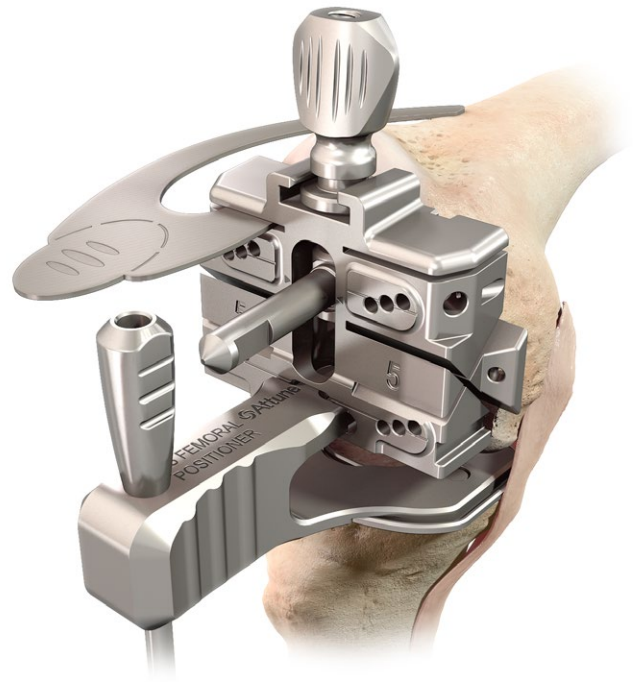

CAUTION

If the Shim size is changed, it may no longer match the extension gap and so the distal cut may need to be reassessed.

Appendix 6: Optional Balancing Block Technique

Femoral Finishing

Secure the Block using Threaded Headed Pins through the convergent pin holes and remove both the IM Rod (using the IM Rod Handle - as used with the INTUITION Balanced Sizer, page 30) and the Femoral Positioner.

If desired, there is an option to add a Modular Saw Capture to the Block through an attachment on the posterior side.

Resection of the femur can then be carried out, as described on pages 40 - 41 of this technique. The saw slots have an internal angle that accommodates a steep cut angle, facilitating completion of the cut. The remaining steps of the workflow are consistent with the core technique (page 42 onwards).

Vibration of the Saw Blade may cause the pivot knob to rotate during sawing. An assistant may hold the knob in place while sawing, or the knob and pivot can be removed from the site if they do separate.

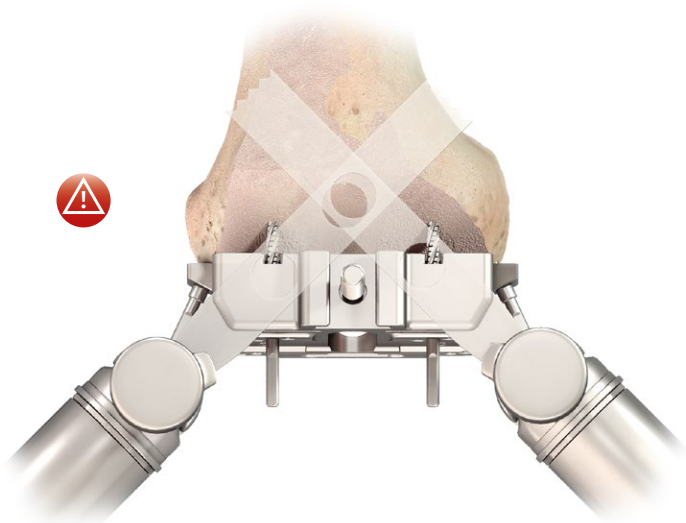
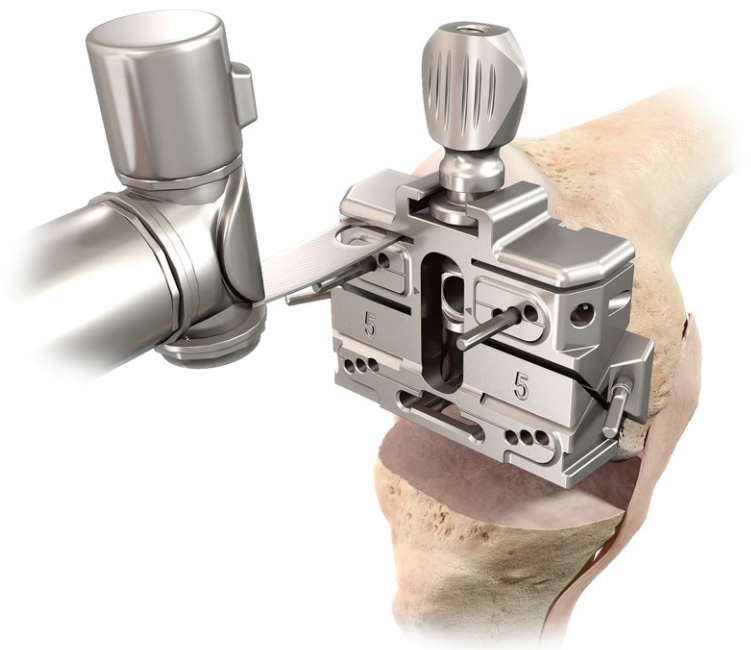
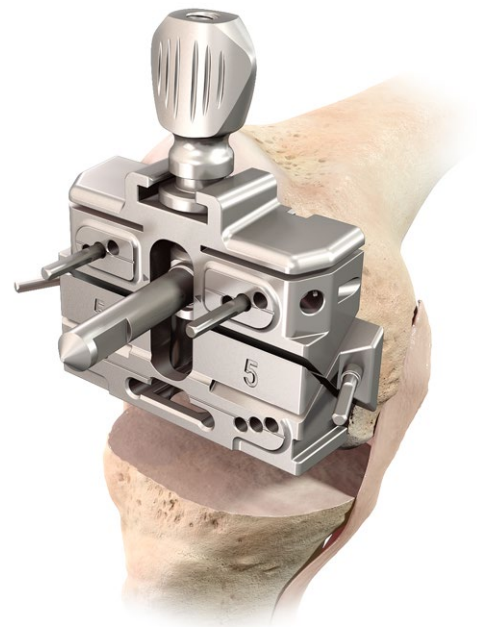

CAUTION

It is recommended to complete the femoral cuts at a steep angle to ensure that the central portion of the bone, behind the central column in the Balancing Block, is cleared.

Flexion/Extension Gap Chart

	Loose Extension	Tight Extension	Stable Extension
Loose Flexion	<p>Cause: Flexion and extension gaps are too large</p> <p>Possible Solution(s):</p> <ul style="list-style-type: none"> • Thicker tibial insert 	<p>Cause: Flexion gap is larger than the extension gap</p> <p>Possible Solution(s):</p> <ul style="list-style-type: none"> • Recut distal femur and use thicker insert • Posterior capsular release • Posteriorize the femoral component by 1.5 mm 	<p>Cause: Flexion gap is larger than extension gap</p> <p>Possible Solution(s):</p> <ul style="list-style-type: none"> • Decrease the tibial slope and use a thicker tibial insert • Recut the distal femur and use a thicker tibial insert • Larger femoral component • Posteriorize the femoral component by 1.5 mm
Tight Flexion	<p>Cause: Extension gap is larger than flexion gap</p> <p>Possible Solution(s):</p> <ul style="list-style-type: none"> • Check for osteophytes • Downsize femoral component and use thicker insert • Increase tibial slope • Recess PCL off of femur or tibia 	<p>Cause: Flexion and extension gaps are too small</p> <p>Possible Solution(s):</p> <ul style="list-style-type: none"> • Thinner tibial insert • Resect additional tibia 	<p>Cause: Flexion gap is too small</p> <p>Possible Solution(s):</p> <ul style="list-style-type: none"> • Check for osteophytes • Downsize femoral component • Anteriorize the femoral component by 1.5 mm • Increase tibial slope • Recess PCL off of femur or tibia
Stable Flexion	<p>Cause: Extension gap is too large</p> <p>Possible Solution(s):</p> <ul style="list-style-type: none"> • Downsize femoral component and increase insert thickness • Increase tibial slope and use thicker tibial insert 	<p>Cause: Extension gap is too small</p> <p>Possible Solution(s):</p> <ul style="list-style-type: none"> • Recut distal femur • Posterior capsular release • Larger femoral component and thinner insert 	<p>Cause: Balanced gaps</p> <p>Possible Solution(s):</p> <ul style="list-style-type: none"> • No solution required

Tibial Component Sizing Chart

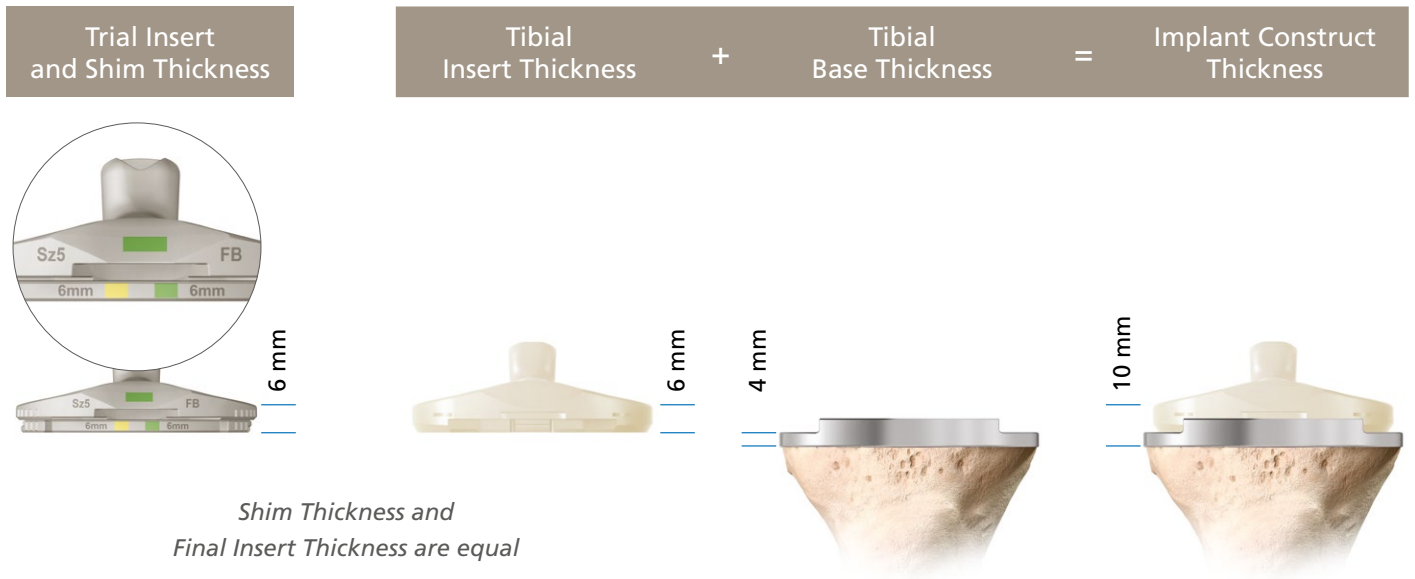







5 mm
6 mm
7 mm
8 mm
10 mm
12 mm
14 mm
16 mm
18 mm (PS only)
20 mm (PS only)

5 mm	+	4 mm	=	9 mm
6 mm	+	4 mm	=	10 mm
7 mm	+	4 mm	=	11 mm
8 mm	+	4 mm	=	12 mm
10 mm	+	4 mm	=	14 mm
12 mm	+	4 mm	=	16 mm
14 mm	+	4 mm	=	18 mm
16 mm	+	4 mm	=	20 mm
18 mm (PS only)	+	4 mm	=	22 mm (PS only)
20 mm (PS only)	+	4 mm	=	24 mm (PS only)

Thickness dimensions are all the same, whether using Cruciate Retaining (CR), Posterior Stabilized (PS) or Rotating Platform or Fixed Bearing combinations.

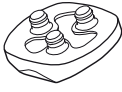
Compatibility Data





SIZE SZ	ATTUNE® CR & PS Femoral	ATTUNE® CR & PS FB Tibial Insert	ATTUNE® CR & PS RP Tibial Insert	ATTUNE® FB & RP Tibial Base										ATTUNE® Medialized Anatomic Patella		ATTUNE® Medialized Dome Patella			
																			
Pink	1	1	1	1	2	3									29	32	35	38	41
Dark Blue	2	2	2	1	2	3	4								29	32	35	38	41
Grey	3/3N	3	3	1	2	3	4	5							29	32	35	38	41
Black	4/4N	4	4		2	3	4	5	6							32	35	38	41
Green	5/5N	5	5			3	4	5	6	7						32	35	38	41
Yellow	6/6N	6	6				4	5	6	7	8					32	35	38	41
Light Blue	7	7	7					5	6	7	8	9					35	38	41
Red	8	8	8						6	7	8	9	10				35	38	41
Purple	9	9	9							7	8	9	10					38	41
Brown	10	10	10								8	9	10					38	41

Ref. Number: 103262475

Symbols on Surgical Instruments

Some of the instruments have markings on them for guidance.

The interpretation of these markings is as detailed in the table below.

Symbol or Text	Definition
	Cleaning position here
	Dismantle for cleaning
	Unlock
	Lock
L	Left
R	Right
LEFT	Left
RIGHT	Right
CR	ATTUNE Cruciate Retaining Implant
PS	ATTUNE Posterior Stabilized Implant
RP	Rotating Platform
FB	Fixed Bearing

Symbol or Text	Definition
L	Lateral (for Patella Trials)
M	Medial (for Patella Trials)
LL	Left Lateral
RL	Right Lateral
SULCUS	Sulcus
FLEXION	Flexion
EXTENSION	Extension
SZ	Size
TIB	Tibia
	Caution
DEG	Degrees
	Cemented/Press-fit Stem Assembly Icon

ATTUNE® KNEE SYSTEM – FIXED BEARING KNEE

IMPORTANT

This Essential Product Information sheet does not include all of the information necessary for selection and use of a device. Please see full labeling for all necessary information.

INTENDED USE

Total knee arthroplasty is intended to provide increased patient mobility and reduced pain by replacing the damaged knee joint articulation in patients where there is evidence of sufficient sound bone to seat and support the components. Total knee replacement may be considered for younger patients if, in the opinion of the surgeon, an unequivocal indication for total knee replacement outweighs the risks associated with the age of the patient, and if limited demands regarding activity and knee joint loading can be assured. This includes severely crippled patients with multiple joint involvement for whom a gain in knee mobility may lead to an expectation of significant improvement in the quality of their lives.

INDICATIONS

Candidates for total knee replacement include patients with a severely painful and/or severely disabled joint resulting from osteoarthritis, post-traumatic arthritis, rheumatoid arthritis, or a failed previous implant.

CONTRAINDICATIONS

The following conditions are contraindications for total knee replacement:

1. Active local or systemic infection.
2. Loss of bone or musculature, osteoporosis, neuromuscular compromise or vascular deficiency in the affected limb in sufficient degree to render the procedure unjustifiable (e.g., absence of musculoligamentous supporting structures, joint neuropathy).
3. Severe instability secondary to advanced loss of osteochondral structure or the absence of collateral ligament integrity.

NOTE: Diabetes, at present, has not been established as a contraindication. However, because of the increased risk for complications such as infection, slow wound healing, etc., the physician should carefully consider the advisability of knee replacement in the severely diabetic patient.

WARNINGS AND PRECAUTIONS

CAUTION:

- ATTUNE® CR Tibial Insert size should be the same size as the selected ATTUNE CR Femoral Component size. ATTUNE CR Tibial Inserts should be within 2 sizes of the ATTUNE Tibial Base.
- ATTUNE PS Tibial Insert size should be the same size as the selected ATTUNE PS Femoral Component size. ATTUNE PS Tibial Insert should be within 2 sizes of the ATTUNE Tibial Base.
- ATTUNE Patella Component:
 - Sizes 38mm and 41mm may be used with all femoral component sizes.
 - Size 29mm may only be used with femoral component sizes 1 through 3.
 - Size 32mm may only be used with femoral component sizes 1 through 6.
 - Size 35mm may only be used with femoral component sizes 1 through 8.
- Implants and trial components from different manufacturers or implant systems should never be used together.
- Knee prosthesis components should never be reimplanted. Even though the implant appears undamaged, the implant may have developed microscopic imperfections which could lead to failure.
- Always use a trial prosthesis for trial purposes. Trials should not be assembled with any components intended for permanent implantation. Trials must have the same configuration size, as the corresponding components to be permanently implanted.
- Do not alter or modify implants in any way.
- Avoid drilling multiple pin holes in the proximal tibia which may affect the compressive strength of the tibia.

NOTE: DePuy's Single Use devices have not been designed to undergo or withstand any form of alteration, such as disassembly, cleaning or re-sterilization, after a single patient use. Reuse can potentially compromise device performance and patient safety.

CAUTION: The following conditions, singularly or concurrently, tend to impose severe loading on the affected extremity thereby placing the patient at higher risk of failure of the knee replacement:

1. Obesity or excessive patient weight.
2. Manual labor.
3. Active sports participation.
4. High levels of patient activity.
5. Likelihood of falls.
6. Alcohol or drug addiction.
7. Other disabilities, as appropriate.

In addition to the above, the following physical conditions, singularly or concurrently, tend to adversely affect the fixation of knee replacement implants:

1. Marked osteoporosis or poor bone stock.
2. Metabolic disorders or systemic pharmacological treatments leading to progressive deterioration of solid bone support for the implant (e.g., diabetes mellitus, steroid therapies, immunosuppressive therapies, etc.).
3. History of general or local infections.
4. Severe deformities leading to impaired fixation or improper positioning of the implant.
5. Tumors of the supporting bone structures.
6. Allergic reactions to implant materials (e.g. bone cement, metal, polyethylene).
7. Tissue reactions to implant corrosion or implant wear debris.
8. Disabilities of other joints (i.e., hips or ankles).

A higher incidence of implant failure has been reported in paraplegics and in patients with cerebral palsy or Parkinson's Disease.

When the surgeon determines that knee replacement is the best medical option available and decides to use this prosthesis in a patient who has any of the above conditions or who is simply young and active, it is imperative that the patient be instructed about the strength limitations of the materials used in the device and for fixation and the resultant need to substantially reduce or eliminate any of the above conditions.

The surgical and postoperative management of the patient must be carried out with due consideration for all existing conditions. Mental attitudes or disorders resulting in a patient's failure to adhere to the surgeon's orders may delay postoperative recovery and/or increase the risk of adverse effects including implant or implant fixation failure.

Excessive physical activity or trauma to the replaced joint may contribute to premature failure of the knee replacement by causing a change in position, fracture, and/or wear of the implants. The functional life expectancy of prosthetic knee implants is, at present, not clearly established. The patient should be informed that factors such as weight and activity levels may significantly affect wear.

MRI SAFETY INFORMATION

The ATTUNE Fixed Bearing Knee System has not been tested for safety and compatibility in the MR environment. The devices have not been tested for heating or migration in the MR environment. Scanning a patient who has this device may result in patient injury.

The risks associated with other passive implants in an MR environment have been evaluated and are known to include heating, migration, and image artifacts at or near the implant site.

ATTUNE® KNEE SYSTEM – ROTATING PLATFORM

IMPORTANT

This Essential Product Information sheet does not include all of the information necessary for selection and use of a device. Please see full labeling for all necessary information.

INTENDED USE

Total knee arthroplasty is intended to provide increased patient mobility and reduced pain by replacing the damaged knee joint articulation in patients where there is evidence of sufficient sound bone to seat and support the components. Total knee replacement may be considered for younger patients if, in the opinion of the surgeon, an unequivocal indication for total knee replacement outweighs the risks associated with the age of the patient, and if limited demands regarding activity and knee joint loading can be assured. This includes severely crippled patients with multiple joint involvement for whom a gain in knee mobility may lead to an expectation of significant improvement in the quality of their lives.

INDICATIONS

The Rotating Platform (RP) Total Knee System is indicated for cemented use in cases of osteoarthritis and rheumatoid arthritis. The rotating platform prosthesis is indicated for primary total knee arthroplasty or the revision of failed knee prostheses.

The CR RP device configuration is indicated for use in knees whose posterior cruciate ligament is intact, absent, or in such condition as to justify its sacrifice.

CONTRAINDICATIONS

The use of the RP Total Knee System is contraindicated in:

- the presence of osteomyelitis, pyrogenic infection or other overt infection of the knee joint. Every effort should be made to rule out the possibility of preoperative sepsis in a patient who has one or more of the following abnormalities:
 - fever or local inflammation;
 - rapid destruction or bone resorption apparent on x-rays;
 - elevation of the erythrocyte sedimentation rate or white blood cell count unexplained by other disease or a marked shift in the white blood cell differential count.
- patients with any active infection at sites such as the genitourinary tract, pulmonary system, skin or any other site. Should a patient have any infection prior to implantation, the foci of the infection must be treated prior to, during and after implantation.
- patients with loss of musculature or neuromuscular compromise leading to loss of function in the involved limb or in whom the requirements for its use would affect recommended rehabilitation procedures.
- patients with severe osteoporosis or other metabolic bone diseases of the knee;
- patients with any of the following conditions:
 - lesions of the supporting bone structures (e.g. aneurysmal or simple bone cysts, giant cell tumor or any malignant tumor),
 - systemic and metabolic disorders leading to progressive deterioration of solid bone support,
 - the presence of severe instability secondary to advanced loss of osteochondral structure or the absence of collateral ligament integrity, fixed deformities greater than 60° of flexion, 45° of genu varus or valgus,
 - known drug or alcohol addiction,
 - skeletally immature individuals and the presence of allergic reaction to implant metals or polyethylene are also contraindications for the use of all device configurations of the RP Total Knee System.

WARNINGS AND PRECAUTIONS

- The correct selection as well as the correct seating/placement of the prosthetic implant is extremely important. During surgery, particular attention to tracking of the patella is also required for a successful result. Thus, failure to use the optimum size implant, failure to adequately seat the component adjacent to adequate bone and failure to ensure that the component is stable may result in dislocation, subsidence, fracture, suboptimal extensor mechanism function, or loosening of the components. The proper size selection, the choice of and careful use of the components and the use of trial prostheses are imperative.
- The ATTUNE CR or PS RP Tibial Insert should be the same size as the selected ATTUNE CR or PS Femoral Component. The ATTUNE CR or PS RP Tibial Inserts articulate with the ATTUNE RP Tibial Bases. ATTUNE CR or PS RP Tibial Inserts should be within 2 sizes of the RP Tibial Base.
- ATTUNE RP Total Knee components, instruments and trial prostheses should not be used together with those of another manufacturer. Because dimensional compatibility cannot be assured, adverse outcomes can result from the use of components from different manufacturers.
- A postoperative management program is vital. It is recommended that the program be modified according to the condition of the patient and the extent of soft tissue and ligament reconstruction.
- The safety and effectiveness of the cemented use of the RP Total Knee in patients under 41 years of age have not been established.
- The implantation of the RP tibial insert and femoral component will not in itself guarantee a high level of post-operative flexion. The degree of post-operative flexion is multi-factorial. These factors include, but are not limited to, surgical technique, patient build, pre-operative flexion and age.

NOTE: DePuy's Single Use devices have not been designed to undergo or withstand any form of alteration, such as disassembly, cleaning or re-sterilization, after a single patient use. Reuse can potentially compromise device performance and patient safety.

MRI SAFETY INFORMATION

The ATTUNE Rotating Platform Knee System has not been tested for safety and compatibility in the MR environment. The devices have not been tested for heating or migration in the MR environment. Scanning a patient who has this device may result in patient injury.

The risks associated with other passive implants in an MR environment have been evaluated and are known to include heating, migration, and image artifacts at or near the implant site.

PRECAUTIONS

The surgeon should discuss all physical and psychological limitations inherent to the use of this device with the patient pre-operatively. Particular discussion should be directed to the issues of premature weight bearing, activity levels and the necessity for periodic medical follow-up.

Surgeons should not begin the clinical use of any knee prosthesis before they have thoroughly familiarized themselves with its specific implantation technique. Certain methods may change with time as further clinical experience is gained. Such changes are presented at regularly scheduled surgical instruction courses for which periodic attendance is advised. Surgical technique brochures, course schedules, and course recordings are available from DePuy.

Particular attention should be paid to the handling of the components. (see **HANDLING** section for further information).

References

1. Scott, R.D. & Chmell, M.J. (2008). Balancing the posterior cruciate ligament during cruciate retaining fixed and mobile-bearing total knee arthroplasty. Description of the pull-out lift off and slide-back tests. *The Journal of Arthroplasty*, 23(4), 605-608.
2. Shepard, M.F., Kabo, J.M., Liebermann, J.R. (2000). Influence of cement technique on the interface strength of femoral components. *Clinical Orthopaedics and Related Research*, Number 381, 26-35.



DePuy Orthopaedics, Inc.

700 Orthopaedic Drive
Warsaw, IN 46582
USA
Tel: +1 (800) 366-8143
Fax: +1 (800) 669-2530

DePuy International, Ltd.

St Anthony's Road
Leeds LS11 8DT
England
Tel: +44 (0) 113 270 0461

DePuy (Ireland)

Loughbeg, Ringaskiddy
Co. Cork, Ireland
Tel: +35 (321) 491 4000
Fax: +35 (321) 491 4199



www.depuysynthes.com

The third party trademarks used herein are the trademarks of their respective owners.
© DePuy Synthes 2017, 2018 All rights reserved.
DSUS/JRC/0316/1437(Rev4) 01/18
DSEM/JRC/0118/0983