

CORail[®]
TOTAL Hip SYSTEM



■ THE SCIENCE OF

simplicity

“The advanced features of the Corail stem, and its bone-preserving surgical technique, have made it a great choice for minimally invasive hip surgery. Twenty years ago, we began a revolution with the use of HA in orthopaedics. Today we face an exciting new era, and we look forward with confidence in sharing continued success with the world's orthopaedic community.”

*ARTRO Group
Design Surgeon Team
Clinique d'Argonay
International Visitation Centre
Annecy, France*

US Surgeon Team

- James Caillouette, MD*
- Charles R. Clark, MD*
- Mark Froimson, MD*
- Jonathan Garino, MD*
- William Lanzer, MD*
- Joel Matta, MD*
- Sam Sydney, MD*

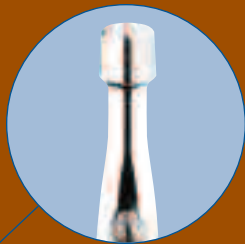

Tapered neck geometry and optimized Articul/eze® taper increase range of motion

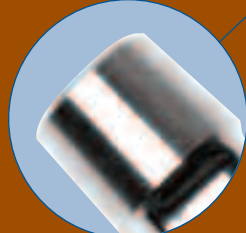

Three offset options to restore hip biomechanics

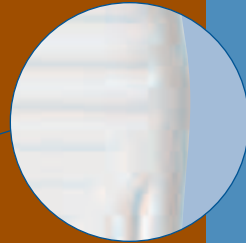

Low-profile lateral shoulder design enables easy insertion in reduced incision techniques



Available in collared or non-collared options



Step geometry converts hoop stresses to compressive loads



Vertical/horizontal grooves provide rotational and axial stability

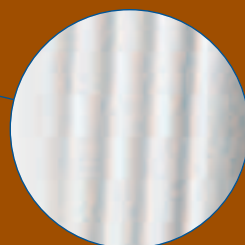

Proprietary HA coating for initial osteointegration and fixation



“I’ve used the Corail since 1998 and with its easy-to-use surgical technique, I choose to use it on many types of patients, including those with osteopenia and in hemiarthroplasty cases for femoral neck fracture treatment.”

Jonathan Garino, MD
Philadelphia,
Pennsylvania

proven fixation

OPERATIVE STABILITY

- Corail stepped geometry is oriented to minimize shear forces and maximize compression loading in host cancellous bone

RAPID OSTEOINTEGRATION

- Proprietary HA coating at 155 microns clinically demonstrated rapid trabeculae formation leading to rapid fixation¹

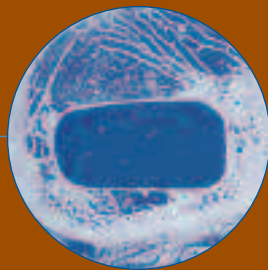

Proximal trapezoid cross section resists axial/torsional stresses and promotes osteointegration for excellent fixation

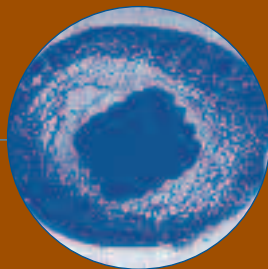

Distal quadrangular cross section provides rotational stability without cortical contact

LONG-TERM FIXATION



98.3%

Survivorship at 10 and 14 years²

98.9%

Survivorship in 100 consecutive cases at 8 years³

95.1%

Survivorship in 5,130 cases at 15 years⁴

"I find the Corail stem design and HA coating provides initial stability for my patients."

William Lanzer, MD
Seattle, Washington

enhanced



NECK ENHANCEMENTS

- Narrowed anterior-posterior neck dimensions and optimized Articul/eze taper increase range of motion and reduce risk of mechanical impingement
- Articul/eze 12/14 taper is fully captured by all nonskirted Articul/eze heads, eliminating the creation of a false skirt due to trunnion protrusion
- Polished neck is designed to generate less wear debris secondary to prosthetic impingement

biomechanics



COLLARLESS STEM OPTIONS

- Standard and high offset collarless stem options enable femoral offset restoration and soft tissue tensioning
- High offset collarless option adds +7 mm of direct lateralization to restore hip biomechanics in a wider range of patients

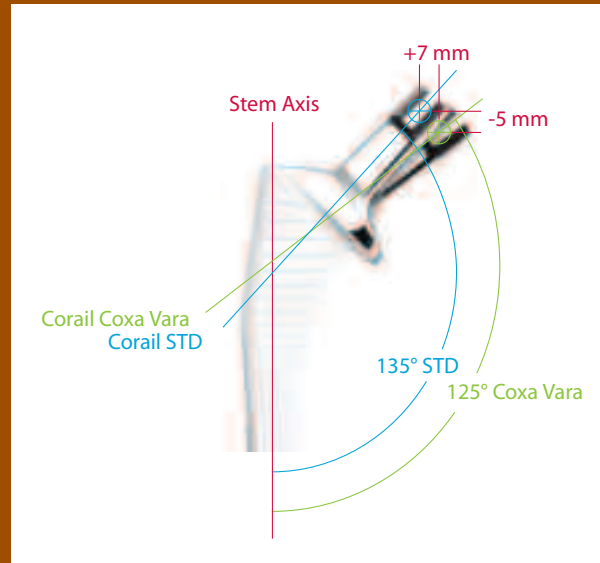

COLLARED STEM OPTIONS

- Available in both standard and coxa vara high offset to control subsidence and add rotational stability in patients with osteopenic bone
- Coxa vara collared neck option offers increased offset and varus neck angles for femoral restoration and proper soft tissue tensioning of varus neck angled patients

“I use the Corail because of its ease of implantation and long track record. Used with the Pinnacle Acetabular Cup System, it lets me select multiple options in order to optimize hip biomechanics in my patients.”

Charles R. Clark, MD
Iowa City, Iowa

bone preserving

COMPACTION BROACHING

- A philosophy of respecting and preserving patient anatomy, biology and physiology...are key to the Corail success
- Compressing and compacting the cancellous bone during the broaching process maintains the medullary canal endosteum, preserving blood supply to the bone and the bone/implant interface



- Creates an excellent bone/implant contact ratio and high pullout strength for initial and long-term fixation
- Increases prosthetic torsional stability



- Preserves the blood supply to promote healing and growth of bone around the implant
- Forms "biological grout" that enhances long-term fixation

philosophy



18 YEARS POST-OP

“Compaction broaching coupled with Corail creates ‘silent’ hip replacement. We don't see any adverse, long-term radiographic changes.”

James Caillouette, MD
Newport Beach, California

“I find the Corail stem and instrumentation facilitate ease of insertion using an anterior approach.”

Joel Matta, MD
Los Angeles, California

heritage

For initial and long-term fixation, the clinical performance of the full HA-coated Corail Total Hip System is reproducible in all types and sizes of femora.⁵



PRE-OP

4 YEARS POST-OP

Type A Champagne Flute



PRE-OP

5 YEARS POST-OP

Type B Proportional Shape



PRE-OP

5 YEARS POST-OP

Type C Stovepipe

"I find it to be reproducible and easy to implant, and use it on many different types of patients."

Sam Sydney, MD
Baltimore, Maryland

"After independently reviewing the ARTRO Group Corail data in 1998, I decided to try the Corail stem. I'm pleased with the results and now use it on many types of patients."

Mark Froimson, MD
Cleveland, Ohio

ESSENTIAL PRODUCT INFORMATION

CORAIL AMT HIP

IMPORTANT This Essential Product Information sheet does not include all of the information necessary for selection and use of a device. Please see full labeling for all necessary information.

INDICATIONS The Corail AMT Hip Prosthesis is intended for use in total hip arthroplasty and is intended for pressfit (uncemented) use. Total hip arthroplasty is intended to provide increased patient mobility and reduce pain by replacing the damaged hip joint articulation in patients where there is evidence of sufficient sound bone to seat and support the components. Total hip replacement is indicated in the following conditions:

1. A severely painful and/or disabled joint from osteoarthritis, traumatic arthritis, rheumatoid arthritis, or congenital hip dysplasia.
2. Avascular necrosis of the femoral head.
3. Acute traumatic fracture of the femoral head or neck.
4. Failed previous hip surgery including joint reconstruction, internal fixation, arthrodesis, hemiarthroplasty, or total hip replacement.
5. Certain cases of ankylosis.

The non-porous Corail AMT Hip Stem is indicated for cementless use only.

CONTRAINDICATIONS The following conditions are contraindications for total or hemi-hip replacement:

1. Active local or systemic infection.
2. Loss of musculature, neuromuscular compromise or vascular deficiency in the affected limb rendering the procedure unjustified.
3. Poor bone quality, such as osteoporosis, where, in the surgeon's opinion, there could be considerable migration of the prosthesis or a significant chance of fracture of the femoral shaft, considerable migration of the prosthesis or a significant chance of fracture of the femoral shaft and/or the lack of adequate bone to support the implant(s).
4. Charcot's or Paget's disease.
5. For hemi-hip arthroplasty, any pathological condition of the acetabulum, such as distorted acetabuli with irregularities, protrusion acetabuli (arthrokatadysis), or migrating acetabuli, that would preclude the use of the natural acetabulum as an appropriate articular surface for the hemi-hip prosthesis.

WARNINGS AND PRECAUTIONS

- HA coated implants must not be implanted with cement
- Stainless steel 316L/CoCr couplings are forbidden
- When changing the head on a femoral stem which is still in place, it is essential to use a metal head

ADVERSE EVENTS The following are the most frequent adverse events after hip arthroplasty: prosthesis working loose, dislocation, infection, thrombosis, cardiovascular disturbances, and hematoma.

REFERENCES

1. Hardy D, Frayssinet P. Hydroxyapatite-coated femoral arthroplasties: A long-term study through 29 Corail prostheses explanted during a ten-year survey. *Surgical Technology International X*. 2003.
2. Vidalain JP. Corail Stem Long-Term Results based on the 15-Years ARTRO Group Experience. *Fifteen Years of Clinical Experience with Hydroxyapatite Coatings in Joint Arthroplasty*, Ed. Springer, 217-224; 2004.
3. Rökkum M, Brandt M, Bye K, Hetland KR, Waage S, Reigstad A. Polyethylene wear, osteolysis and acetabular loosening with an HA coated hip prosthesis. A follow-up of 94 consecutive arthroplasties. *J Bone Joint Surg Br*. 1999;81(4):582-9.
4. Furnes O, Espehaug B, Lie S, Engesaeter LB, Vollset S, Hallan G, Fenstad AM, Havelin LI. Prospective studies of hip and knee prostheses. The Norwegian Arthroplasty Register. 1987-2004. Scientific exhibition presented at the 72nd Annual Meeting of the American Academy of Orthopaedic Surgeons, February 23-27, 2005, Washington, DC, USA.
5. Chatelet JC, Setiey L. Long-term study of osteolysis around the hydroxyapatite-coated total hip arthroplasty without cement. *British Editorial Society of Bone and Joint Surgery*. 2004;86-B (supple 1):39.

For more information about DePuy products, visit our web site at www.jnjgateway.com or www.depuyorthopaedics.com.

SURGICAL TECHNIQUE: THE SCIENCE OF SIMPLICITY



STEP 1:
Neck Osteotomy



STEP 2:
Femoral Canal Preparation



STEP 3:
Offset Selection &
Head Trialing

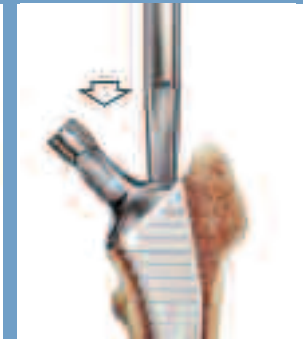

STEP 4:
Femoral Component
Insertion



DePuy Orthopaedics, Inc.
700 Orthopaedic Drive
Warsaw, IN 46581-0988
USA
Tel: +1 (800) 366 8143
Fax: +1 (574) 267 7196

DePuy International Ltd
St Anthony's Road
Leeds LS11 8DT
England
Tel: +44 (113) 387 7800
Fax: +44 (113) 387 7890