



Scan the code above to learn more about our Spinal portfolio.



# Spine



Biopsy Needles	2	Knives	91
Bone Waxers	2	Mallets	91
Calipers	2	Osteotomes	93
Chisels	3	Packers	102
Containers	7	Pins	102
Curettes	13	Probes	102
Cutters	38	Rasps	103
Dissectors	38	Retractors	104
Distractors	42	Rongeurs	136
Dowel Instruments	43	Screws	189
Drills	45	Shavers	189
Drivers	47	Spreaders	190
Elevators	48	Sterilizing Case Containers	191
Files	58	Suction Tubes	192
Forceps	58	Tamps	194
Gauges	62	Spine Pliers	195
Gouges	63	Trephines	196
Holdings	66	Wire and Pin Cutters	196
Hooks	67	Wire Twisters	199
Impactors	69	Wrenches	199
Kits	72		
Knife Handles	91		

## Biopsy Needles (Vertebral)

### Craig Vertebral Body Biopsy

CODE	DESCRIPTION
24-2506	Vertebral Body Biopsy
24-2505	Vertebral Body Biopsy
24-2504	Vertebral Body Biopsy



24-2504 Tip

## Bone Waxers (Cervical)

### Cervical Bone Waxter

CODE	DESCRIPTION	WORKING DISTANCE	TOTAL LENGTH
46-2648	XL Cervical	4 $\frac{1}{10}$ in 104 mm	9 $\frac{1}{2}$ in 240 mm

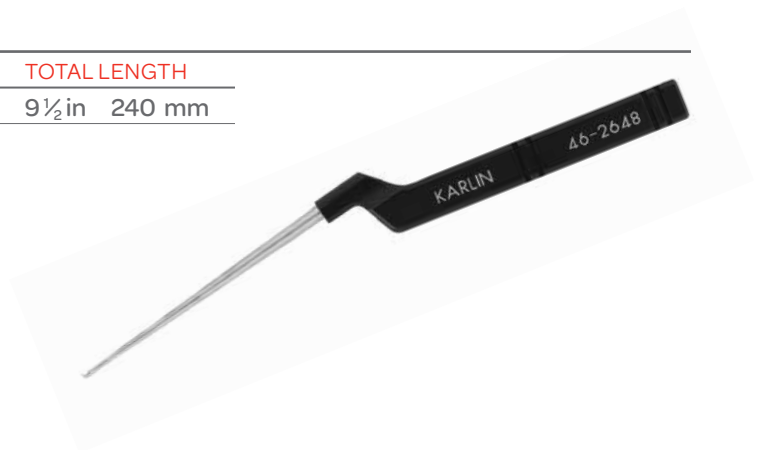

## Calipers (ACF)

### ACF Caliper

CODE	DESCRIPTION
59-0120	Caliper



## Chisels (Bone)

### Bone Chisel

CODE	DESCRIPTION
29-0401	#3, Stout

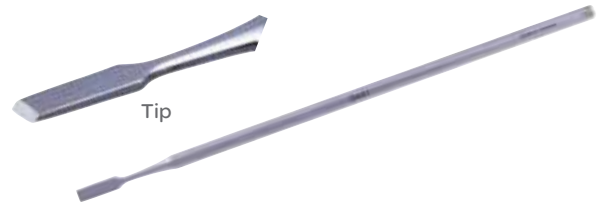

## Chisels (Cervical)

### Cervical Chisel

CODE	BLADE WIDTH	LENGTH
18-1013	4 mm	7 in 178 mm



## Chisels (Lamina)

### Derrico Lamina Chisel

CODE	BLADE WIDTH	LENGTH
18-1010	½ in 13 mm	7½ in 191 mm



## Chisels (Spinal)

### Spinal Fusion Chisel

CODE	DESCRIPTION	BLADE WIDTH	LENGTH
67-7001	Straight	$\frac{15}{64}$ in 0.6 mm	10½ in 267 mm



## Chisels

### Alexander Chisel

CODE	DESCRIPTION	BLADE WIDTH	LENGTH
28-2606	Straight	$\frac{1}{4}$ in 6 mm	7 in 178 mm

Image Not Available



### Bishop Chisel

CODE	DESCRIPTION	BLADE WIDTH	LENGTH
27-6004	Chisel	$\frac{1}{8}$ in 4 mm	6 in 152 mm

Image Not Available



### Chisel

CODE	DESCRIPTION	BLADE WIDTH	LENGTH
18-1011	Straight	$\frac{15}{64}$ in 0.6 mm	9 $\frac{1}{2}$ in 241 mm
67-7018	Straight	$\frac{3}{4}$ in 19 mm	9 $\frac{1}{2}$ in 241 mm



18-1011

### Hibbs Chisel

CODE	DESCRIPTION	BLADE WIDTH	LENGTH
28-5006	Straight	$\frac{1}{4}$ in 6 mm	9 $\frac{1}{2}$ in 241 mm
28-5010	Straight	$\frac{3}{8}$ in 10 mm	9 $\frac{1}{2}$ in 241 mm
28-5012	Straight	$\frac{1}{2}$ in 12 mm	9 $\frac{1}{2}$ in 241 mm
28-5016	Straight	$\frac{5}{8}$ in 16 mm	9 $\frac{1}{2}$ in 241 mm
28-5020	Straight	$\frac{3}{4}$ in 19 mm	9 $\frac{1}{2}$ in 241 mm
28-5025	Straight	1 in 25 mm	9 $\frac{1}{2}$ in 241 mm
28-5032	Straight	1 $\frac{1}{4}$ in 32 mm	9 $\frac{1}{2}$ in 241 mm
28-5056	Curved	$\frac{1}{4}$ in 6 mm	9 $\frac{1}{2}$ in 241 mm
28-5062	Curved	$\frac{1}{2}$ in 12 mm	9 $\frac{1}{2}$ in 241 mm
28-5070	Curved	$\frac{3}{4}$ in 19 mm	9 $\frac{1}{2}$ in 241 mm
28-5075	Curved	1 in 25 mm	9 $\frac{1}{2}$ in 241 mm

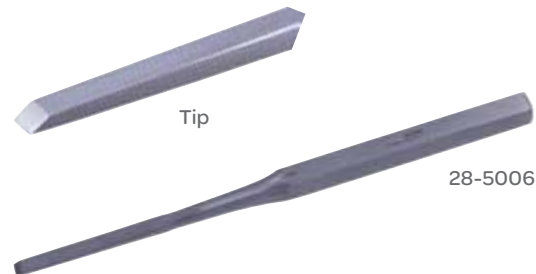

Tip

28-5006

## Chisels

## Lexer Chisel

CODE	DESCRIPTION	BLADE WIDTH		LENGTH	
28-5407	Chisel	¼ in	6 mm	7 in	178 mm
28-5412	Chisel	⅜ in	10 mm	7 in	178 mm
28-5410	Chisel	½ in	12 mm	7 in	178 mm
28-5433	Chisel		10 mm	8 ⅝ in	219 mm
28-5435	Chisel		15 mm	8 ⅝ in	219 mm
28-5439	Chisel		30 mm	8 ⅝ in	219 mm



## Magnum Straight Curved Chisel Set

Set of Six, Curved

CODE	TIP WIDTH	HANDLE DIAMETER		LENGTH	
46-3110	Set Includes:				
46-3111	6 mm	1 ¼ in	32 mm	10 ¾ in	273 mm
46-3112	10 mm	1 ¼ in	32 mm	10 ¾ in	273 mm
46-3113	15 mm	1 ¼ in	32 mm	10 ¾ in	273 mm
46-3114	20 mm	1 ¼ in	32 mm	10 ¾ in	273 mm
46-3115	25 mm	1 ¼ in	32 mm	10 ¾ in	273 mm
46-3116	30 mm	1 ¼ in	32 mm	10 ¾ in	273 mm
46-3107	Magnum Instrument Case for 6 Chisels				



## Magnum Straight Chisel Set

Set of Six, Straight

CODE	TIP WIDTH	HANDLE DIAMETER		LENGTH	
46-3100	Set Includes:				
46-3101	6 mm	1 ¼ in	32 mm	10 ¾ in	273 mm
46-3102	10 mm	1 ¼ in	32 mm	10 ¾ in	273 mm
46-3103	15 mm	1 ¼ in	32 mm	10 ¾ in	273 mm
46-3104	20 mm	1 ¼ in	32 mm	10 ¾ in	273 mm
46-3105	25 mm	1 ¼ in	32 mm	10 ¾ in	273 mm
46-3106	30 mm	1 ¼ in	32 mm	10 ¾ in	273 mm
46-3107	Magnum Instrument Case for 6 Chisels				



## Chisels

### Puka Chisel

CODE	NO.	LENGTH
18-1014	#1	4 in 102 mm
67-7003	#2	11 in 279 mm



18-1014

### Stiletto Chisel

CODE	DESCRIPTION	TIP SIZE	LENGTH
46-3083	Curved	½ in 6 mm	8½ in 216 mm

Image Not Available



### Stiletto Chisel Set

CODE	DESCRIPTION	TIP SIZE
46-3070	Set Includes:	
46-3071	Straight	¼ in 6 mm
46-3072	Straight	⅜ in 10 mm
46-3073	Straight	½ in 13 mm
46-3074	Straight	⅝ in 16 mm
46-3075	Straight	¾ in 19 mm
46-3076	Case for Straight Stiletto Chisels	



## Chisels

### Stille Chisel

CODE	DESCRIPTION	TIP SIZE	LENGTH
28-4320	Straight	20 mm	8 in 203 mm
28-4325	Straight	25 mm	8 in 203 mm

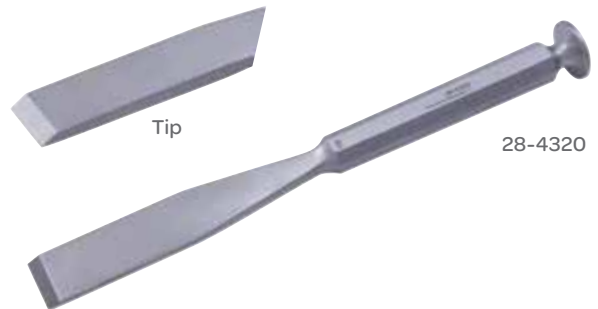

### US Army Chisel

CODE	TIP SIZE	LENGTH
28-2006	¼ in 6 mm	6¼ in 159 mm
28-2012	½ in 12 mm	6¼ in 159 mm
28-2018	¾ in 18 mm	6¼ in 159 mm

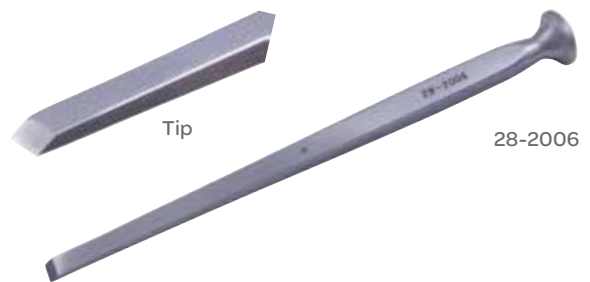

## Containers (Silicone Retainer Bracket)

### Silicone Retainer Bracket

CODE	DESCRIPTION	LENGTH
2-8109	Ideal for Rectangular Geometry	1½ x 2 in 38 x 51 mm
2-8110	Ideal for Rectangular Geometry	3 x 2 in 76 x 51 mm
2-8105	Expandable, Ideal for Rectangular Geometry	3 x 2 in 76 x 51 mm

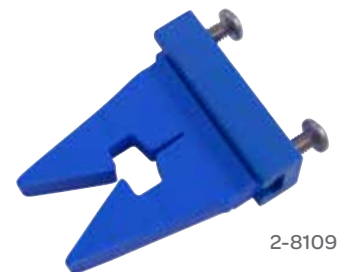



## Containers (Silicone Support Bracket)

### Silicone Support Bracket

CODE	DESCRIPTION	LENGTH
2-8108	Ideal for Round Geometry	3 x 2 in 76 x 51 mm
2-8112	Ideal for Rectangular Geometry	3 x 2 in 76 x 51 mm

Image Not Available



## Containers (Sterilizing Case)

### Case for Curved Stiletto Chisels

CODE	DESCRIPTION	LENGTH
46-3086	Case for Chisels	9 in 228 mm

Image Not Available



### Case K Sterilizing

CODE	DESCRIPTION	DEPTH	WIDTH	LENGTH
50-1664	Crockard Case K Sterilizing	7¼ in 184 mm	10½ in 266 mm	18 in 457 mm



## Containers (Sterilizing Case)

### Craig Vertebral Biopsy Case

CODE	DESCRIPTION
24-2510	Vertebral Biopsy Case

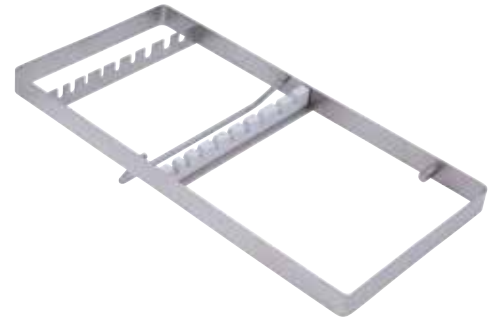

### Gouge and Osteotome Case

CODE	WIDTH	DEPTH	LENGTH
21-2500	6 7/8 in 175 mm	2 1/4 in 57 mm	9 in 229 mm



### Instrument Case for Anterior Cervical Fusion Instruments

CODE	DESCRIPTION
21-1001	For use with 80-1004, Anterior Fusion Kit



## Containers (Sterilizing Case)

### Lumbar Set Container

CODE	DESCRIPTION
59-1700	For Use with Ultra Lumbar Kit

Image Not Available



### Magnum Ring Curette

CODE	DESCRIPTION
46-3407	PG Magnum Sterilizing Case (12), Holds 12 Curettes. For Use with 46-3400

Image Not Available



### Microsect Curette Tray

CODE	DESCRIPTION
47-5023	Microsect Curette Tray



### Osseous Dissection Instruments Sterilizing Case

CODE	DESCRIPTION
46-2613	For Use with Micro Osseous Dissection Instruments



## Containers (Sterilizing Case)

### Spinal Curette Storage and Sterilizing Case

CODE	DESCRIPTION	WIDTH		LENGTH	
21-1022	Holds Nine Sizes of Curettes	7¼ in	184 mm	9¾ in	248 mm
21-1003	Holds Nine Sizes of Curettes	7¼ in	184 mm	11¾ in	299 mm



### Sterilizing and Carrying Case

CODE	DESCRIPTION	WIDTH		DEPTH	
21-1020	Holds 8 Gouges or Osteotomes	8⅞ in	225 mm	1¼ in	32 mm



## Containers (Sterilizing Case)

### Sterilizing O.R. Display Case

CODE	DESCRIPTION	LENGTH		WIDTH	
46-3003	Sterilizing O.R. Display Case for use with the Spondylophyte Impaction Set or four (4) straight handled instruments and a black 90° Dural Suction Retractor. Keeper Blade holds instruments in place.	10 in	250 mm	4½ in	110 mm



Instruments not included.

### Storage/Sterilizing Case for 12 XL Magnum Instruments

CODE	DESCRIPTION	LENGTH	
46-3222	Double sided	13½ in	342 mm



## Curettes (Bone)

### Bone Curette

CODE	DESCRIPTION	CUP	LENGTH	
29-7076	Straight	3.6 mm	10 in	254 mm
29-7077	Straight	4.4 mm	10 in	254 mm
29-7078	Straight	5.2 mm	10 in	254 mm
29-7079	Straight	6 mm	10 in	254 mm
29-7070	Angled	3.6 mm	10 in	254 mm
29-7071	Angled	4.4 mm	10 in	254 mm
29-7072	Angled	5.2 mm	10 in	254 mm
29-7073	Angled	6 mm	10 in	254 mm



### Bone Curette

CODE	DESCRIPTION	CUP	LENGTH	
29-4902	Oval	2 mm	7 in	178 mm
29-4906	Oval	6 mm	7 in	178 mm



### Jansen Bone Curette

Double-Ended

CODE	DESCRIPTION	LENGTH	
29-8372	2.5 mm and 3 mm Oval Tips, Angled	6 in	152 mm



### Martini Bone Curette

Double-Ended, Round

CODE	DESCRIPTION	LENGTH	
29-8010	#00/0	5½ in	140 mm
29-8011	#0/1	5½ in	140 mm
29-8012	#1/2	5½ in	140 mm



## Curettes (Bone)

### Spratt Bone Curette

Oval, Delicate Pattern

CODE	DESCRIPTION	LENGTH
29-6333	#000	7 1/8 in 181 mm
29-6342	#00	7 1/8 in 181 mm
29-6350	#0	7 1/8 in 181 mm
29-6351	#1	7 1/8 in 181 mm
29-6352	#2	7 1/8 in 181 mm
29-6353	#3	7 1/8 in 181 mm
29-6354	#4	7 1/8 in 181 mm

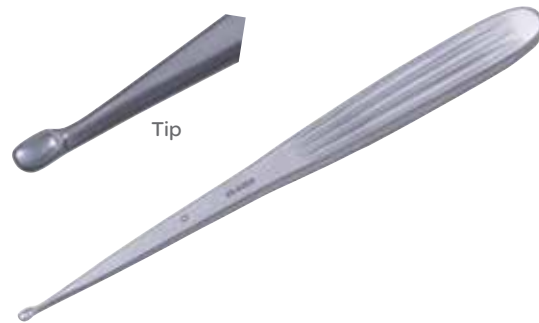

### Williger Bone Curette

CODE	DESCRIPTION	LENGTH
29-8312	Double-Ended, 3 mm and 4 mm	5 1/2 in 140 mm

Image Not Available



## Curettes (Cervical)

### Cervical Axial Curette

CODE	DESCRIPTION	LENGTH
57-4919	Straight Down, #000000	9 in 229 mm
57-4908	Angled Down, #00000	9 in 229 mm
57-4907	Angled Down, #000000	9 in 229 mm

Image Not Available



### Cervical Axial Curette

CODE	DESCRIPTION	LENGTH
57-4901	Forward Angled, #000000	9 in 229 mm
57-4902	Forward Angled, #00000	9 in 229 mm

Image Not Available



## Curettes (Cervical)

### Cervical Axial Curette

CODE	DESCRIPTION	LENGTH
57-4932	Forward Down, #00000	9 in 229 mm
57-4936	Forward Down, #0	9 in 229 mm



### Cervical Axial Curette

CODE	DESCRIPTION	LENGTH
57-4914	Forward Straight, #00000	9 in 229 mm



### Sales Team Training

When it comes to training our sales force, Symmetry Surgical's resources are truly exceptional! Each sales team member is clinically trained as a surgical instrument specialist – receiving comprehensive, hands-on clinical training from our staff, our surgeon inventors and our product specialists.

### Legacy of Innovation

Many of Symmetry Surgical's innovations have come directly from practicing clinicians. We collaborate with our customers to identify and solve problems they face in their clinical practice – and pride ourselves on bringing the best solution forward.

### Our Portfolio

With a robust pipeline and broad portfolio, Symmetry Surgical boasts one of the most comprehensive instrument and medical device offerings in the marketplace today. A leader in the surgical instrument market, we are 100% focused on surgical instrumentation. Our breadth of product line enables our customers to depend on us for virtually all of their surgical instrumentation needs.



## Curettes (Cervical)



### Cervical Microdiscectomy, Set of 24 Instruments

CODE	DESCRIPTION	DESCRIPTION	LENGTH
46-3150	Set Includes:		8 ½ in 216 mm
46-3161	Cervical Microdiscectomy Curette	Backward Straight, 0	8 ½ in 216 mm
46-3162	Cervical Microdiscectomy Curette	Backward Straight, 00	8 ½ in 216 mm
46-3163	Cervical Microdiscectomy Curette	Backward Straight, 000	8 ½ in 216 mm
46-3164	Cervical Microdiscectomy Curette	Backward Straight, 0000	8 ½ in 216 mm
46-3166	Cervical Microdiscectomy Curette	Backward Angle, 0	8 ½ in 216 mm
46-3167	Cervical Microdiscectomy Curette	Backward Angle, 00	8 ½ in 216 mm
46-3168	Cervical Microdiscectomy Curette	Backward Angle, 000	8 ½ in 216 mm
46-3169	Cervical Microdiscectomy Curette	Backward Angle, 0000	8 ½ in 216 mm
46-3151	Cervical Microdiscectomy Curette	Forward Straight, 0	8 ½ in 216 mm
46-3152	Cervical Microdiscectomy Curette	Forward Straight, 00	8 ½ in 216 mm
46-3153	Cervical Microdiscectomy Curette	Forward Straight, 000	8 ½ in 216 mm
46-3154	Cervical Microdiscectomy Curette	Forward Straight, 0000	8 ½ in 216 mm
46-3156	Cervical Microdiscectomy Curette	Forward Angle, 0	8 ½ in 216 mm
46-3157	Cervical Microdiscectomy Curette	Forward Angle, 00	8 ½ in 216 mm
46-3158	Cervical Microdiscectomy Curette	Forward Angle, 000	8 ½ in 216 mm
46-3159	Cervical Microdiscectomy Curette	Forward Angle, 0000	8 ½ in 216 mm
46-3165	Cervical Cortical Bone Cutter	Backward Straight	8 ½ in 216 mm
46-3170	Cervical Cortical Bone Cutter	Backward Angle	8 ½ in 216 mm
46-3155	Cervical Cortical Bone Cutter	Forward Straight	8 ½ in 216 mm
46-3160	Cervical Cortical Bone Cutter	Forward Angle	8 ½ in 216 mm
46-3171	Micro Nerve Hook		8 ½ in 216 mm
46-3172	Ultra Micro Nerve Hook		8 ½ in 216 mm
46-3173	Cervical Bone Waxer		8 ½ in 216 mm
46-3175	Storage/Sterilizing Case, For 12 Instruments 2 Provided with Kit		

## Curettes (Cervical)

### Karlin XL Cervical Curette

CODE	DESCRIPTION	LENGTH
46-2626	Forward Straight, 0	4 1/10 x 3/5 x 9 1/2 in 104 x 15 x 241 mm
46-2627	Forward Straight, 00	4 1/10 x 3/5 x 9 1/2 in 104 x 15 x 241 mm
46-2628	Forward Straight, 000	4 1/10 x 3/5 x 9 1/2 in 104 x 15 x 241 mm
46-2629	Forward Straight, 0000	4 1/10 x 3/5 x 9 1/2 in 104 x 15 x 241 mm
46-2631	Forward Angle, 0	4 1/10 x 3/5 x 9 1/2 in 104 x 15 x 241 mm
46-2632	Forward Angle, 00	4 1/10 x 3/5 x 9 1/2 in 104 x 15 x 241 mm
46-2633	Forward Angle, 000	4 1/10 x 3/5 x 9 1/2 in 104 x 15 x 241 mm
46-2634	Forward Angle, 0000	4 1/10 x 3/5 x 9 1/2 in 104 x 15 x 241 mm
46-2636	Backward Straight, 0	4 1/10 x 3/5 x 9 1/2 in 104 x 15 x 241 mm
46-2637	Backward Straight, 00	4 1/10 x 3/5 x 9 1/2 in 104 x 15 x 241 mm
46-2638	Backward Straight, 000	4 1/10 x 3/5 x 9 1/2 in 104 x 15 x 241 mm
46-2639	Backward Straight, 0000	4 1/10 x 3/5 x 9 1/2 in 104 x 15 x 241 mm
46-2645	Backward Angle	4 1/10 x 3/5 x 9 1/2 in 104 x 15 x 241 mm
46-2641	Backward Angle, 0	4 1/10 x 3/5 x 9 1/2 in 104 x 15 x 241 mm
46-2642	Backward Angle, 00	4 1/10 x 3/5 x 9 1/2 in 104 x 15 x 241 mm
46-2643	Backward Angle, 000	4 1/10 x 3/5 x 9 1/2 in 104 x 15 x 241 mm
46-2644	Backward Angle, 0000	4 1/10 x 3/5 x 9 1/2 in 104 x 15 x 241 mm



46-2626

## Curettes (Cone Ring)

### Cone Ring Curette

CODE	DESCRIPTION	RING I.D.	LENGTH
23-1013	#1, Straight	5/16 in 8 mm	9 in 229 mm
23-1014	#2, Straight	1/4 in 6 mm	9 in 229 mm
23-1015	#3, Straight	1/8 in 3 mm	9 in 229 mm
23-1020C	Angled 5°	5/16 in 8 mm	9 in 229 mm
23-1021C	Angled 30°	5/16 in 8 mm	9 in 229 mm

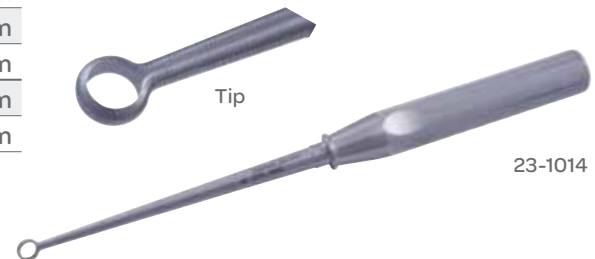

23-1014

## Curettes (Cervical)

### Cone Ring Curette

CODE	DESCRIPTION	DESCRIPTION	LENGTH
57-4703	Straight	9 mm	9 in 229 mm
57-4713	Angled	9 mm	9 in 229 mm

Image Not Available



## Curettes (Cup)

### Karlin XL Magnum Cup Curette

CODE	DESCRIPTION	DESCRIPTION	LENGTH
46-3226	Forward Straight	7 mm	13 ¼ in 337 mm
46-3227	Forward Straight	9 mm	13 ¼ in 337 mm
46-3228	Forward Straight	11 mm	13 ¼ in 337 mm
46-3229	Forward Straight	13 mm	13 ¼ in 337 mm
46-3230	Forward Straight	15 mm	13 ¼ in 337 mm
46-3236	Forward Straight	17 mm	13 ¼ in 337 mm
46-3237	Forward Straight	19 mm	13 ¼ in 337 mm
46-3231	Forward Angle	7 mm	13 ¼ in 337 mm
46-3232	Forward Angle	9 mm	13 ¼ in 337 mm
46-3233	Forward Angle	11 mm	13 ¼ in 337 mm
46-3234	Down Pushing	7 mm	13 ¼ in 337 mm
46-3235	Down Pushing	9 mm	13 ¼ in 337 mm

Image Not Available



## Curettes (Cup)

200 mm



46-3410

### Magnum Cup Curette Kit

PG - Set of 12, Large Capacity Cup, Sizes Permit Rapid Tissue Removal

CODE	DESCRIPTION	DESCRIPTION	LENGTH	TOTAL LENGTH
46-3410	Set of 12 with case, includes the following:			
46-3411	Forward Straight	PG 7 mm	7 $\frac{1}{8}$ in 200 mm	12 $\frac{3}{5}$ in 320 mm
46-3412	Forward Straight	PG 9 mm	7 $\frac{1}{8}$ in 200 mm	12 $\frac{3}{5}$ in 320 mm
46-3413	Forward Straight	PG 11 mm	7 $\frac{1}{8}$ in 200 mm	12 $\frac{3}{5}$ in 320 mm
46-3414	Forward Straight	PG 13 mm	7 $\frac{1}{8}$ in 200 mm	12 $\frac{3}{5}$ in 320 mm
46-3415	Forward Straight	PG 15 mm	7 $\frac{1}{8}$ in 200 mm	12 $\frac{3}{5}$ in 320 mm
46-3416	Forward Straight	PG 17 mm	7 $\frac{1}{8}$ in 200 mm	12 $\frac{3}{5}$ in 320 mm
46-3417	Forward Straight	PG 19 mm	7 $\frac{1}{8}$ in 200 mm	12 $\frac{3}{5}$ in 320 mm
46-3418	Forward Angle	PG 7 mm	7 $\frac{1}{8}$ in 200 mm	12 $\frac{3}{5}$ in 320 mm
46-3419	Forward Angle	PG 9 mm	7 $\frac{1}{8}$ in 200 mm	12 $\frac{3}{5}$ in 320 mm
46-3420	Forward Angle	PG 11 mm	7 $\frac{1}{8}$ in 200 mm	12 $\frac{3}{5}$ in 320 mm
46-3421	Forward Down Pushing	PG 7 mm	7 $\frac{1}{8}$ in 200 mm	12 $\frac{3}{5}$ in 320 mm
46-3422	Forward Down Pushing	PG 9 mm	7 $\frac{1}{8}$ in 200 mm	12 $\frac{3}{5}$ in 320 mm

## Curettes (Lumbar)

### Lumbar Axial Curette

CODE	DESCRIPTION	LENGTH
57-4968	Angled Down, #000000	10 ¼ in 260 mm
57-4969	Angled Down, #00000	10 ¼ in 260 mm
57-4970	Angled Down, #0000	10 ¼ in 260 mm
57-4971	Angled Down, #000	10 ¼ in 260 mm
57-4972	Angled Down, #00	10 ¼ in 260 mm
57-4973	Angled Down, #0	10 ¼ in 260 mm



### Lumbar Axial Curette

CODE	DESCRIPTION	LENGTH
57-4950	Reverse Angle Up, #000000	10 ¼ in 260 mm
57-4951	Reverse Angle Up, #00000	10 ¼ in 260 mm
57-4952	Reverse Angle Up, #0000	10 ¼ in 260 mm
57-4953	Reverse Angle Up, #000	10 ¼ in 260 mm
57-4954	Reverse Angle Up, #00	10 ¼ in 260 mm
57-4955	Reverse Angle Up, #0	10 ¼ in 260 mm



### Lumbar Axial Curette

CODE	DESCRIPTION	LENGTH
57-4980	Straight Down, #000000	10 ¼ in 260 mm
57-4981	Straight Down, #00000	10 ¼ in 260 mm
57-4982	Straight Down, #0000	10 ¼ in 260 mm
57-4983	Straight Down, #000	10 ¼ in 260 mm
57-4984	Straight Down, #00	10 ¼ in 260 mm
57-4985	Straight Down, #0	10 ¼ in 260 mm



## Curettes (Lumbar)

### Lumbar Axial Curette

CODE	DESCRIPTION	LENGTH
57-4962	Angled Up, #000000	10 ¼ in 260 mm
57-4963	Angled Up, #00000	10 ¼ in 260 mm
57-4964	Angled Up, #0000	10 ¼ in 260 mm
57-4965	Angled Up, #000	10 ¼ in 260 mm
57-4966	Angled Up, #00	10 ¼ in 260 mm
57-4967	Angled Up, #0	10 ¼ in 260 mm



### Lumbar Axial Curette

CODE	DESCRIPTION	LENGTH
57-4956	Reverse Angle Down, #000000	10 ¼ in 260 mm
57-4957	Reverse Angle Down, #00000	10 ¼ in 260 mm
57-4958	Reverse Angle Down, #0000	10 ¼ in 260 mm
57-4959	Reverse Angle Down, #000	10 ¼ in 260 mm
57-4960	Reverse Angle Down, #00	10 ¼ in 260 mm
57-4961	Reverse Angle Down, #0	10 ¼ in 260 mm



### Lumbar Axial Curette

CODE	DESCRIPTION	LENGTH
57-4974	Straight Up, #000000	10 ¼ in 260 mm
57-4975	Straight Up, #00000	10 ¼ in 260 mm
57-4976	Straight Up, #0000	10 ¼ in 260 mm
57-4977	Straight Up, #000	10 ¼ in 260 mm
57-4978	Straight Up, #00	10 ¼ in 260 mm
57-4979	Straight Up, #0	10 ¼ in 260 mm



## Curettes (Lumbar)

### Lumbar Microdiscectomy Curette

CODE	DESCRIPTION	LENGTH
46-3133	Backwards Angle, 0	9½ in 241 mm
46-3134	Backwards Angle, 1	9½ in 241 mm
46-3135	Backwards Angle, 2	9½ in 241 mm

Image Not Available



### Lumbar Microdiscectomy Curette

CODE	DESCRIPTION	LENGTH
46-3136	Backwards Down, 0	9½ in 241 mm
46-3137	Backwards Down, 1	9½ in 241 mm
46-3138	Backwards Down, 2	9½ in 241 mm

Image Not Available



### Lumbar Microdiscectomy Curette

CODE	DESCRIPTION	LENGTH
46-3130	Backwards Straight, 0	9½ in 241 mm
46-3131	Backwards Straight, 1	9½ in 241 mm
46-3132	Backwards Straight, 2	9½ in 241 mm

Image Not Available



### Lumbar Microdiscectomy Curette

CODE	DESCRIPTION	LENGTH
46-3124	Forward Angle, 0	9½ in 241 mm
46-3125	Forward Angle, 1	9½ in 241 mm
46-3126	Forward Angle, 2	9½ in 241 mm

Image Not Available



### Lumbar Microdiscectomy Curette

CODE	DESCRIPTION	LENGTH
46-3127	Forward Down, 0	9½ in 241 mm
46-3128	Forward Down, 1	9½ in 241 mm
46-3129	Forward Down, 2	9½ in 241 mm

Image Not Available



## Curettes (Lumbar)

### Lumbar Microdiscectomy Curette

CODE	DESCRIPTION	LENGTH
46-3121	Forward Straight, 0	9½ in 241 mm
46-3122	Forward Straight, 1	9½ in 241 mm
46-3123	Forward Straight, 2	9½ in 241 mm

Image Not Available



## Curettes (Micro)

Micro Osseous Dissection instruments are designed for the microsurgical removal of bony, calcified or other firm tissues. These instruments can be used in conjunction with a high speed drill to thin bone before removal.

### Micro Curette

Bayonet

CODE	DESCRIPTION	WORKING DISTANCE
46-2609	45° Up, 0000	3 in 76 mm
46-2608	45° Up, 000	3 in 76 mm
46-2607	45° Up, 00	3 in 76 mm



46-2607

### Micro Curette

Bayonet

CODE	DESCRIPTION	WORKING DISTANCE
46-2612	80° Down, 0000	3 in 76 mm
46-2611	80° Down, 000	3 in 76 mm
46-2610	80° Down, 00	3 in 76 mm

Image Not Available



### Micro Curette

Bayonet

CODE	DESCRIPTION	WORKING DISTANCE
46-2606	Straight, 0000	3 in 76 mm
46-2605	Straight, 000	3 in 76 mm

Image Not Available





## Curettes (Ring)

### Karlin Magnum Ring Curette

Ring, Extra Long Curettes, Black Handles, Lightweight

CODE	DESCRIPTION	TIP SIZE	LENGTH
46-3215	Set of six (6) includes the following:		13¼ in 337 mm
46-3216	XL Straight	6 mm	13¼ in 337 mm
46-3217	XL Straight	8 mm	13¼ in 337 mm
46-3218	XL Straight	10 mm	13¼ in 337 mm
46-3219	XL Angled	6 mm	13¼ in 337 mm
46-3220	XL Angled	8 mm	13¼ in 337 mm
46-3221	XL Angled	10 mm	13¼ in 337 mm

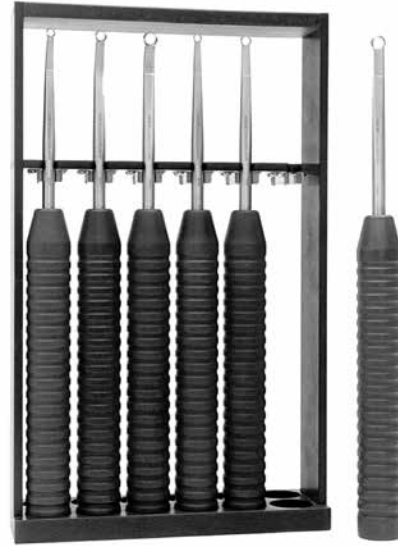

46-3215

### Magnum Ring Curette

CODE	DESCRIPTION	TIP SIZE	LENGTH
46-3401	Straight	PG 6 mm	4 9/10 x 1 3/25 x 7 4/5 x 12 3/5 in 125 x 28 x 198 x 320 mm
46-3402	Straight	PG 8 mm	4 9/10 x 1 3/25 x 7 4/5 x 12 3/5 in 125 x 28 x 198 x 320 mm
46-3403	Straight	PG 10 mm	4 9/10 x 1 3/25 x 7 4/5 x 12 3/5 in 125 x 28 x 198 x 320 mm
46-3404	Angle	PG 6 mm	4 9/10 x 1 3/25 x 7 4/5 x 12 3/5 in 125 x 28 x 198 x 320 mm
46-3405	Angle	PG 8 mm	4 9/10 x 1 3/25 x 7 4/5 x 12 3/5 in 125 x 28 x 198 x 320 mm
46-3406	Angle	PG 10 mm	4 9/10 x 1 3/25 x 7 4/5 x 12 3/5 in 125 x 28 x 198 x 320 mm

Image Not Available



## Curettes (Spinal)

### Semmes Spinal Fusion Curette

CODE	DESCRIPTION	RING SIZE	LENGTH
29-4950	Straight	5 x 8 mm	9 in 229 mm
23-1035	Straight	4 x 7 mm	9 in 229 mm
29-4952	Full Curve	5 x 8 mm	9 in 229 mm
23-1036	Slightly Curved	4 x 7 mm	9 in 229 mm



### Spinal Curette

CODE	DESCRIPTION	LENGTH
23-1081	Straight 000	11 in 279 mm
23-1082	Straight 00	11 in 279 mm
23-1083	Straight 0	11 in 279 mm
23-1084	Straight 1	11 in 279 mm
23-1085	Straight 2	11 in 279 mm
23-1086	Straight 3	11 in 279 mm
23-1087	Straight 4	11 in 279 mm
23-1088	Straight 5	11 in 279 mm
23-1089	Straight 6	11 in 279 mm



### Spinal Fusion Curette

Oval

CODE	DESCRIPTION	LENGTH
29-4860	Straight #000	11 in 279 mm
29-4861	Straight #00	11 in 279 mm
29-4862	Straight #0	11 in 279 mm
29-4863	Straight #1	11 in 279 mm
29-4865	Straight #3	11 in 279 mm
29-4866	Straight #4	11 in 279 mm
29-4867	Straight #5	11 in 279 mm
29-4868	Straight #6	11 in 279 mm



## Curettes (Spinal)

### Spinal Fusion Curette

Oval

CODE	DESCRIPTION	LENGTH
29-6010A	Angled #00000	12 in 305 mm
29-6011A	Angled #0000	12 in 305 mm
29-6012A	Angled #000	12 in 305 mm
29-6013A	Angled #00	12 in 305 mm
29-6014A	Angled #0	12 in 305 mm
29-6015A	Angled #1	12 in 305 mm
29-6016A	Angled #2	12 in 305 mm
29-6017A	Angled #3	12 in 305 mm
29-6018A	Angled #4	12 in 305 mm
29-6020A	Angled #6	12 in 305 mm

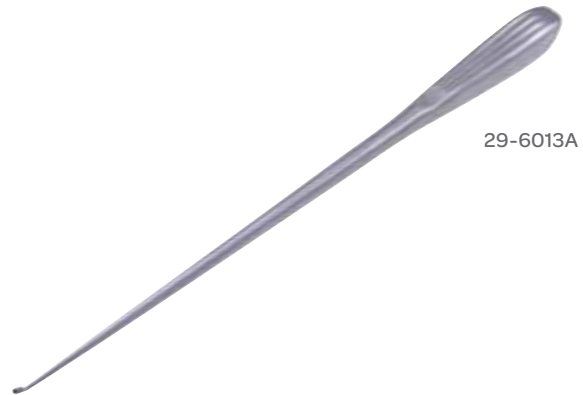

29-6013A

### Spinal Fusion Curette

Oval

CODE	DESCRIPTION	LENGTH
29-6010	Straight #00000	12 in 305 mm
29-6011	Straight #0000	12 in 305 mm
29-6012	Straight #000	12 in 305 mm
29-6013	Straight #00	12 in 305 mm
29-6014	Straight #0	12 in 305 mm
29-6015	Straight #1	12 in 305 mm
29-6016	Straight #2	12 in 305 mm
29-6017	Straight #3	12 in 305 mm
29-6019	Straight #5	12 in 305 mm
29-6020	Straight 6	12 in 305 mm

Image Not Available



### Spinal Fusion Curette

Oval

CODE	DESCRIPTION	LENGTH
29-4936	Angled #00000	8 in 203 mm
29-4937	Angled #0000	8 in 203 mm
29-4938	Angled #000	8 in 203 mm
29-4939	Angled #00	8 in 203 mm
29-4940	Angled #0	8 in 203 mm
29-4941	Angled #1	8 in 203 mm

Image Not Available



## Curettes (Spinal)

### Spinal Fusion Curette

Oval

CODE	DESCRIPTION	LENGTH	
29-5026	Straight #00000	8 in	203 mm
29-5028	Straight #000	8 in	203 mm
29-5029	Straight #00	8 in	203 mm
29-5030	Straight #0	8 in	203 mm
29-5032	Straight #2	8 in	203 mm

Image Not Available



### Spinal Fusion Curette

CODE	DESCRIPTION	LENGTH	
23-1051	Angled 000	8 in	203 mm
23-1052	Angled 00	8 in	203 mm
23-1053	Angled 0	8 in	203 mm
23-1054	Angled, No. 1	8 in	203 mm
23-1055	Angled, No. 2	8 in	203 mm
23-1056	Angled, No. 3	8 in	203 mm
23-1057	Angled, No. 4	8 in	203 mm
23-1058	Angled, No. 5	8 in	203 mm
23-1059	Angled, No. 6	8 in	203 mm

Image Not Available



### Spinal Fusion Curette

CODE	DESCRIPTION	LENGTH	
23-1041	Straight 000	8 in	203 mm
23-1042	Straight 00	8 in	203 mm
23-1043	Straight 0	8 in	203 mm
23-1044	Straight, No. 1	8 in	203 mm
23-1045	Straight, No. 2	8 in	203 mm
23-1046	Straight, No. 3	8 in	203 mm
23-1047	Straight, No. 4	8 in	203 mm
23-1048	Straight, No. 5	8 in	203 mm
23-1049	Straight, No. 6	8 in	203 mm



23-1041

SPINE

## Curettes (Spinal)

### Spinal Fusion Curette

Oval

CODE	DESCRIPTION	LENGTH
29-5407	Reverse Angle, #00000	9 in 229 mm
29-5399	Reverse Angle, #00	9 in 229 mm
29-5400	Reverse Angle, #0	9 in 229 mm
29-5401	Reverse Angle, #1	9 in 229 mm
29-5402	Reverse Angle, #2	9 in 229 mm

Image Not Available



### Spinal Fusion Curette

CODE	DESCRIPTION	LENGTH
23-1061	Straight 000	9 in 229 mm
23-1062	Straight 00	9 in 229 mm
23-1063	Straight 0	9 in 229 mm
23-1064	Straight, No. 1	9 in 229 mm
23-1065	Straight, No. 2	9 in 229 mm
23-1066	Straight, No. 3	9 in 229 mm
23-1067	Straight, No. 4	9 in 229 mm
23-1068	Straight, No. 5	9 in 229 mm
23-1069	Straight, No. 6	9 in 229 mm

Image Not Available



### Spinal Fusion Curette

Angled, 30° Up

CODE	CUP	DESCRIPTION	LENGTH
67-7220	#000000	2x3.5 mm	11 in 280 mm
67-7219	#00000	2.5 x 4 mm	11 in 280 mm
67-7218	#0000	3 x 5 mm	11 in 280 mm

Image Not Available



## Curettes (Spinal)

### Spinal Fusion Curette

Straight

CODE	CUP	DESCRIPTION	LENGTH
67-7186	#000	3.5 x 5 mm	13 in 330 mm
67-7187	#00	4 x 5.5 mm	13 in 330 mm
67-7188	#0	4.5 x 6.5 mm	13 in 330 mm
67-7189	#1	5 x 7.5 mm	13 in 330 mm
67-7190	#2	6 x 10 mm	13 in 330 mm
67-7191	#3	7 x 11 mm	13 in 330 mm
67-7192	#4	8.5 x 13 mm	13 in 330 mm
67-7193	#5	9.5 x 14.5 mm	13 in 330 mm
67-7194	#6	10.5 x 17 mm	13 in 330 mm
67-7209	#000	3.5 x 5 mm	15 in 381 mm
67-7211	#00	4 x 5.5 mm	15 in 381 mm
67-7212	#0	4.5 x 6.5 mm	15 in 381 mm
67-7221	#1	5 x 7.5 mm	15 in 381 mm
67-7213	#2	6 x 10 mm	15 in 381 mm
67-7214	#3	7 x 11 mm	15 in 381 mm
67-7215	#4	8.5 x 13 mm	15 in 381 mm
67-7216	#5	9.5 x 14.5 mm	15 in 381 mm

Image Not Available



## Curettes

### Bruns Curette

CODE	CUP SIZE	DESCRIPTION	LENGTH
32-3400	000	3.2 mm	9 in 229 mm
32-3401	00	3.4 mm	9 in 229 mm
32-3402	0 10 in Receiving	3.7 mm	9 in 229 mm
32-3403	1	4.7 mm	9 in 229 mm
32-3404	2	5.7 mm	9 in 229 mm
32-3405	3	7 mm	9 in 229 mm
32-3406	4	8.4 mm	9 in 229 mm
32-3407	5	8.9 mm	9 in 229 mm
32-3408	6	10.2 mm	9 in 229 mm



32-3402

SPINE

## Curettes

### Bruns Curette

CODE	DESCRIPTION	LENGTH
29-5533A	Angled #000	9 in 229 mm
29-5542A	Angled #00	9 in 229 mm
29-5550A	Angled #0	9 in 229 mm
29-5551A	Angled #1	9 in 229 mm
29-5552A	Angled #2	9 in 229 mm
29-5553A	Angled #3	9 in 229 mm
29-5554A	Angled #4	9 in 229 mm
29-5555A	Angled #5	9 in 229 mm
29-5556A	Angled #6	9 in 229 mm



### Bruns Curette

CODE	DESCRIPTION	LENGTH
29-5550	Straight #0	9 in 229 mm
29-5542	Straight #00	9 in 229 mm
29-5533	Straight #000	9 in 229 mm
29-5524	Straight #0000	9 in 229 mm
29-5551	Straight #1	9 in 229 mm
29-5552	Straight #2	9 in 229 mm
29-5553	Straight #3	9 in 229 mm
29-5554	Straight #4	9 in 229 mm
29-5555	Straight #5	9 in 229 mm
29-5556	Straight #6	9 in 229 mm



### Bruns Curette

Forward Angle

CODE	CUP SIZE	DESCRIPTION	LENGTH
32-3480	0000	3 mm	9 in 229 mm
32-3481	000	3.3 mm	9 in 229 mm
32-3482	00	3.9 mm	9 in 229 mm
32-3483	0	4.5 mm	9 in 229 mm
32-3484	1	5.3 mm	9 in 229 mm
32-3485	2	6 mm	9 in 229 mm
32-3486	3	7.2 mm	9 in 229 mm
32-3487	4	8.2 mm	9 in 229 mm
32-3488	5	9.8 mm	9 in 229 mm
32-3489	6	12.5 mm	9 in 229 mm



## Curettes

## Bruns Curette

Reverse Angle

CODE	CUP SIZE	DESCRIPTION	LENGTH
32-3490	0000	3 mm	9 in 229 mm
32-3491	000	3.2 mm	9 in 229 mm
32-3492	00	3.4 mm	9 in 229 mm
32-3493	0	3.7 mm	9 in 229 mm
32-3494	1	4.7 mm	9 in 229 mm
32-3495	2	5.7 mm	9 in 229 mm
32-3496	3	7 mm	9 in 229 mm
32-3497	4	8.4 mm	9 in 229 mm
32-3498	5	8.9 mm	9 in 229 mm
32-3499	6	10.2 mm	9 in 229 mm

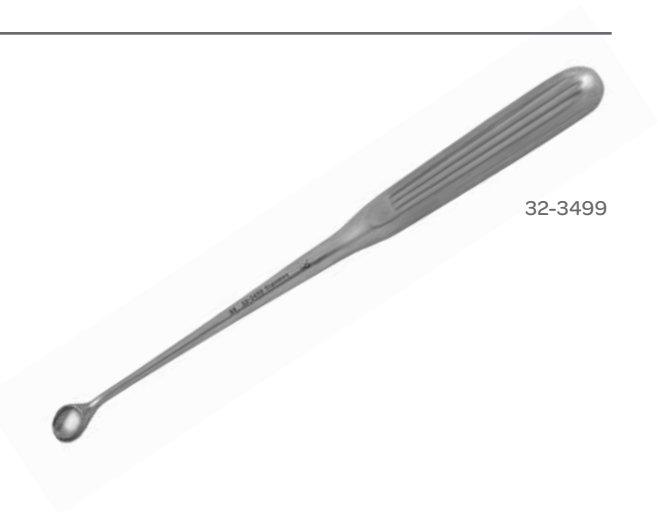

32-3499

## Bruns Curette

Straight

CODE	CUP SIZE	DESCRIPTION	LENGTH
32-3470	0000	3 mm	9 in 229 mm
32-3471	000	3.2 mm	9 in 229 mm
32-3472	00	3.4 mm	9 in 229 mm
32-3473	0	3.7 mm	9 in 229 mm
32-3474	1	4.7 mm	9 in 229 mm
32-3475	2	5.7 mm	9 in 229 mm
32-3476	3	7 mm	9 in 229 mm
32-3477	4	8.4 mm	9 in 229 mm
32-3478	5	8.9 mm	9 in 229 mm
32-3479	6	10.2 mm	9 in 229 mm

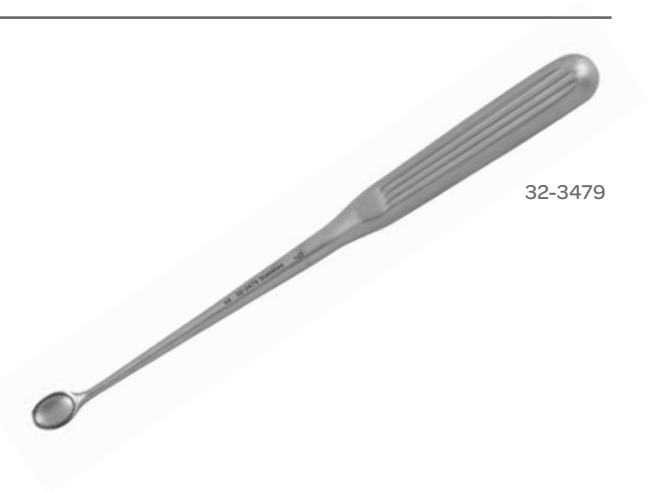

32-3479

## Bruns Curette

Angled, Oval

CODE	DESCRIPTION	LENGTH
29-5123A	#00000	6 <sup>3</sup> / <sub>4</sub> in 171 mm
29-5124A	#0000	6 <sup>3</sup> / <sub>4</sub> in 171 mm
29-5133A	#000	6 <sup>3</sup> / <sub>4</sub> in 171 mm
29-5142A	#00	6 <sup>3</sup> / <sub>4</sub> in 171 mm
29-5150A	#0	6 <sup>3</sup> / <sub>4</sub> in 171 mm
29-5151A	#1	6 <sup>3</sup> / <sub>4</sub> in 171 mm
29-5152A	#2	6 <sup>3</sup> / <sub>4</sub> in 171 mm
29-5153A	#3	6 <sup>3</sup> / <sub>4</sub> in 171 mm
29-5154A	#4	6 <sup>3</sup> / <sub>4</sub> in 171 mm
29-5155A	#5	6 <sup>3</sup> / <sub>4</sub> in 171 mm
29-5156A	#6	6 <sup>3</sup> / <sub>4</sub> in 171 mm



Image Not Available



## Curettes

### Bruns Curette

Straight, Oval

CODE	DESCRIPTION	LENGTH
29-5123	#00000	6¾ in 171 mm
29-5124	#0000	6¾ in 171 mm
29-5133	#000	6¾ in 171 mm
29-5142	#00	6¾ in 171 mm
29-5150	#0	6¾ in 171 mm
29-5151	#1	6¾ in 171 mm
29-5152	#2	6¾ in 171 mm
29-5153	#3	6¾ in 171 mm
29-5154	#4	6¾ in 171 mm
29-5155	#5	6¾ in 171 mm
29-5156	#6	6¾ in 171 mm

Image Not Available



### Bruns Curette

Angled, Oval

CODE	DESCRIPTION	LENGTH
29-5359	#000000	9 in 229 mm
29-5360	#00000	9 in 229 mm
29-5364	#0000	9 in 229 mm
29-5373	#000	9 in 229 mm
29-5382	#00	9 in 229 mm
29-5390	#0	9 in 229 mm
29-5391	#1	9 in 229 mm
29-5392	#2	9 in 229 mm
29-5393	#3	9 in 229 mm
29-5394	#4	9 in 229 mm
29-5395	#5	9 in 229 mm
29-5396	#6	9 in 229 mm

Image Not Available



## Curettes

### Bruns Curette

Straight, Oval

CODE	DESCRIPTION	LENGTH	
29-5320	#00000	9 in	229 mm
29-5324	#0000	9 in	229 mm
29-5333	#000	9 in	229 mm
29-5342	#00	9 in	229 mm
29-5350	#0	9 in	229 mm
29-5351	#1	9 in	229 mm
29-5352	#2	9 in	229 mm
29-5353	#3	9 in	229 mm
29-5354	#4	9 in	229 mm
29-5355	#5	9 in	229 mm
29-5356	#6	9 in	229 mm

Image Not Available



### Caspar Curette

CODE	DESCRIPTION	TIP SIZE	LENGTH	
32-3410	Reverse	4 mm	9 3/4 in	248 mm
32-3411	Reverse	5 mm	9 3/4 in	248 mm



32-3410

### Cobb Curette

Handle Angled

CODE	DESCRIPTION	LENGTH	
29-8818A	Angled #000	11 in	279 mm
29-8819A	Angled #00	11 in	279 mm
29-8820A	Angled #0	11 in	279 mm
29-8821A	Angled #1	11 in	279 mm
29-8822A	Angled #2	11 in	279 mm
29-8823A	Angled #3	11 in	279 mm
29-8824A	Angled #4	11 in	279 mm
29-8825A	Angled #5	11 in	279 mm
29-8826A	Angled #6	11 in	279 mm

Image Not Available



## Curettes

### Cobb Curette

CODE	DESCRIPTION	TIP SIZE	LENGTH
23-2570	#000	3.25 mm	11 in 279 mm
23-2571	#00	4 mm	11 in 279 mm
23-2572	#0	5 mm	11 in 279 mm
23-2573	#1	6 mm	11 in 279 mm
23-2574	#2	7.5 mm	11 in 279 mm
23-2575	#3	9 mm	11 in 279 mm
23-2576	#4	11.5 mm	11 in 279 mm
23-2577	#5	13 mm	11 in 279 mm
23-2578	#6	15.5 mm	11 in 279 mm

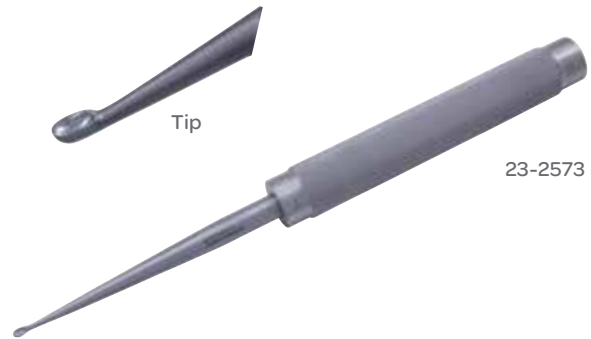

### Cobb Curette

Straight

CODE	DESCRIPTION	LENGTH
57-4800	Size 0000	15 in 381 mm
57-4801	Size 000	15 in 381 mm
57-4802	Size 00	15 in 381 mm



### Cobb Curette

Straight

CODE	DESCRIPTION	LENGTH
67-7107	2.5 x 4 mm	12½ in 318 mm
67-7104	2 x 3.3 mm	12½ in 318 mm
67-7105	2 x 3.3 mm	12½ in 318 mm
67-7111	3.5 x 6 mm	12½ in 318 mm
67-7109	3 x 5 mm	12½ in 318 mm
67-7113	4.5 x 7.5 mm	12½ in 318 mm
67-7115	5.5 x 9 mm	12½ in 318 mm
67-7117	7.5 x 11.5 mm	12½ in 318 mm
67-7119	8.5 x 13 mm	12½ in 318 mm
67-7121	10 x 15.5 mm	12½ in 318 mm
67-7108	2.5 x 4 mm	14 in 356 mm
67-7106	2 x 3.3 mm	14 in 356 mm
67-7112	3.5 x 6 mm	14 in 356 mm
67-7110	3 x 5 mm	14 in 356 mm
67-7114	4.5 x 7.5 mm	14 in 356 mm
67-7116	5.5 x 9 mm	14 in 356 mm
67-7118	7.5 x 11.5 mm	14 in 356 mm
67-7120	8.5 x 13 mm	14 in 356 mm
67-7122	10 x 15.5 mm	14 in 356 mm



## Curettes

## Cobb Curette

Handle Angled

CODE	DESCRIPTION	LENGTH
29-8823	Straight #3	11 in 279 mm

Image Not Available



## Epstein Curette

CODE	DESCRIPTION	LENGTH
57-4620	#000	8 in 203 mm
57-4621	#00	8 in 203 mm
57-4622	#0	8 in 203 mm
57-4625	#0	10 in 254 mm

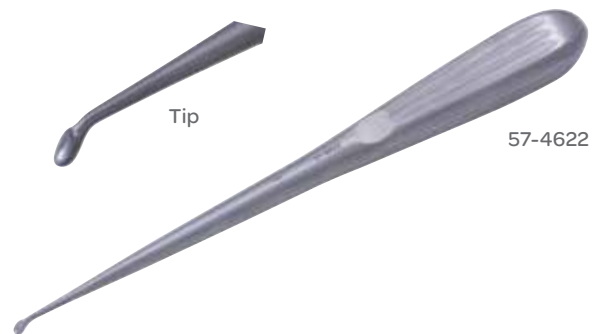

## Hardy Bay Curette

Ring Angled Up

CODE	DESCRIPTION	LENGTH
67-7139	2 mm	9 ½ in 241 mm
67-7140	2 mm	11 in 280 mm
67-7142	3 mm	11 in 280 mm
67-7144	5 mm	11 in 280 mm
67-7141	2 mm	13 in 330 mm
67-7143	3 mm	13 in 330 mm
67-7145	5 mm	13 in 330 mm

Image Not Available



## Hardy Bay Curette

Ring Angled Down

CODE	DESCRIPTION	LENGTH
67-7146	2 mm	9 ½ in 241 mm
67-7147	2 mm	11 in 280 mm
67-7149	3 mm	11 in 280 mm
67-7151	5 mm	11 in 280 mm
67-7148	2 mm	13 in 330 mm
67-7150	3 mm	13 in 330 mm
67-7152	5 mm	13 in 330 mm

Image Not Available



## Curettes

### Hardy Bay Curette

Ring Angled 90° Left

CODE	DESCRIPTION	LENGTH
67-7153	2 mm	9½ in 241 mm
67-7154	2 mm	11 in 280 mm
67-7156	3 mm	11 in 280 mm
67-7158	5 mm	11 in 280 mm
67-7155	2 mm	13 in 330 mm
67-7157	3 mm	13 in 330 mm
67-7159	5 mm	13 in 330 mm

Image Not Available



### Hardy Bay Curette

Ring Angled 45° Right

CODE	DESCRIPTION	LENGTH
67-7160	2 mm	9½ in 241 mm
67-7161	2 mm	11 in 280 mm
67-7163	3 mm	11 in 280 mm
67-7165	5 mm	11 in 280 mm
67-7162	2 mm	13 in 330 mm
67-7164	3 mm	13 in 330 mm
67-7166	5 mm	13 in 330 mm

Image Not Available



### Hardy Bay Curette

Distal Tip Curved Right

CODE	DESCRIPTION	LENGTH
67-7167	5 mm	11 in 280 mm
67-7168	5 mm	13 in 330 mm

Image Not Available



### Hardy Bay Curette

Distal Tip Curved Left

CODE	DESCRIPTION	LENGTH
67-7169	5 mm	11 in 280 mm
67-7170	5 mm	13 in 330 mm

Image Not Available



## Curettes

### Microsect Curette

CODE	DESCRIPTION	SIZE	LENGTH	
47-5012	Backward Angle	#1	10 in	254 mm
47-5014	Backward Angle	#2	10 in	254 mm
47-5016	Backward Angle	#3	10 in	254 mm
47-5018	Backward Angle	#4	10 in	254 mm
47-5020	Backward Angle	#5	10 in	254 mm
47-5011	Forward Angle	#1	10 in	254 mm
47-5013	Forward Angle	#2	10 in	254 mm
47-5015	Forward Angle	#3	10 in	254 mm
47-5017	Forward Angle	#4	10 in	254 mm
47-5019	Forward Angle	#5	10 in	254 mm

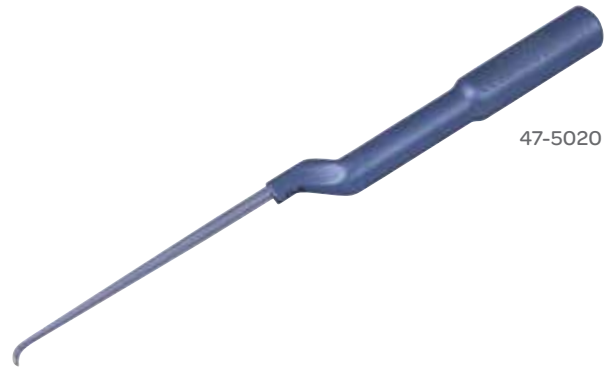

### Scoville Curette

CODE	DESCRIPTION	DESCRIPTION	LENGTH	
67-7171	Straight	4 x 10 mm	12 in	305 mm
67-7172	Straight	4 x 10 mm	14 in	356 mm
67-7173	Straight	6 x 10 mm	15 in	381 mm



### Scoville Curette

CODE	DESCRIPTION	CUP SIZE	LENGTH	
67-7174	Lateral	4 x 10 mm	12 in	305 mm
67-7175	Lateral	4 x 10 mm	14 in	356 mm
67-7176	Lateral	6 x 10 mm	15 in	381 mm
67-7177	Angular	4 x 10 mm	12 in	305 mm
67-7178	Angular	4 x 10 mm	14 in	356 mm
67-7179	Angular	6 x 10 mm	15 in	381 mm



### Scoville Curette

CODE	DESCRIPTION	CUP SIZE	LENGTH	
23-1000	Straight	4 x 10 mm	10 in	254 mm
23-1002	Angular	4 x 10 mm	10 in	254 mm
23-1001	Lateral	4 x 10 mm	10 in	254 mm



## Curettes

### Volkman Curette

Double-Ended

CODE	DESCRIPTION	LENGTH
29-8501	Round and Oval Cups	5 in 127 mm
29-8503	Round and Oval Cups	8 in 203 mm
29-8514	Round and Oval Cups	5½ in 140 mm
29-8502	Round and Oval Cups	6½ in 165 mm
29-8513	Round and Oval Cups	5 in 127 mm
29-8517	Round and Oval Cups	6¾ in 171 mm

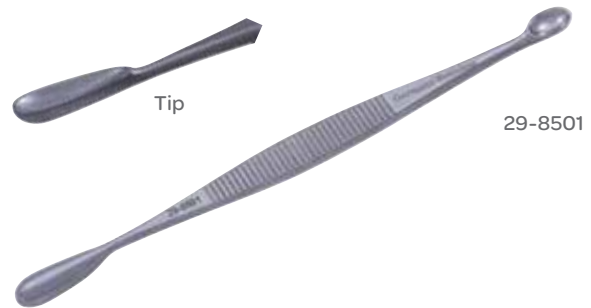

## Cutters (Bone)

### Karlin XL Bone Cutter

CODE	DESCRIPTION	WORKING DISTANCE	TOTAL LENGTH
46-2630	Forward Straight	4 ¼ in 104 mm	9 ½ in 240 mm
46-2640	Backward Straight	4 ¼ in 104 mm	9 ½ in 240 mm
46-2635	Forward Angle	4 ¼ in 104 mm	9 ½ in 240 mm

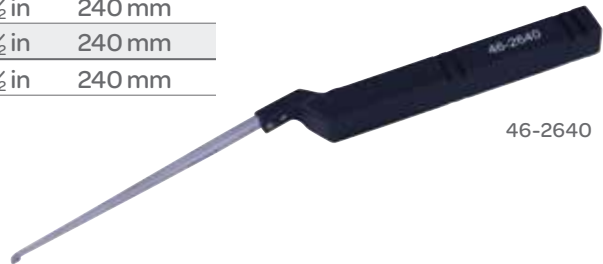

## Dissectors (Annular)

### Annular Dissector Perforator

Tip Tapers ¼ in (6 mm) to ⅛ in (3 mm)

CODE	TIP LENGTH	LENGTH
46-3006	½ in 13 mm	8¾ in 222 mm

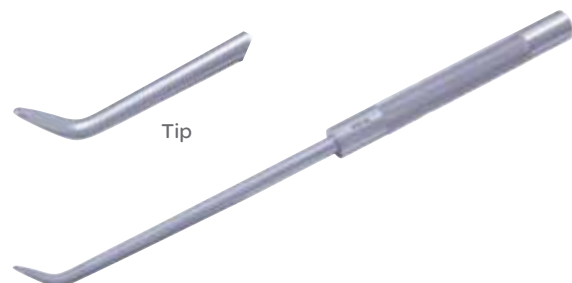

## Dissectors (Vertebral)

### Vertebral Body Dissector

Caspar Type

CODE	DESCRIPTION
57-5699	Small, Stainless Steel
57-5700	Large, Stainless Steel

Image Not Available

### Dissector

Blunt

CODE	DESCRIPTION	LENGTH
67-7418	Double-Ended Packer	12 ½ in 317 mm
67-7419	Double-Ended Packer	13 ½ in 343 mm

Image Not Available

### Dissector

CODE	DESCRIPTION	LENGTH
67-7410	Spoon	12 ½ in 318 mm
67-7411	Spoon	13 ½ in 343 mm

Image Not Available

## Dissectors

### Crockard Bayonet Micro-Dissector

CODE	DESCRIPTION	LENGTH
50-1665	For Transoral Dissection	10 in 254 mm





## Dissectors

### Microset Dissector

Straight Dissector

CODE	DESCRIPTION	LENGTH
47-5021	3 mm	10 in 254 mm
47-5022	5 mm	10 in 254 mm

Image Not Available



### Milligan Dissector

Double-Ended

CODE	TIP SIZE	LENGTH
65-1038	14 mm and 16 mm	8½ in 216 mm



### Oldberg Dissector

CODE	DESCRIPTION	LENGTH
26-4809	Dissector	7 in 178 mm

Image Not Available



### Penfield Dissector

CODE	SIZE	DESCRIPTION	LENGTH
65-1015	1	Broad Curved Dissector, and Sharp Round Spoon, Double-Ended	7 in 178 mm
65-1016	2	Slightly Curved Dissector, and Wax Packer, Double-Ended	7¾ in 197 mm
65-1017	3	Full Curved Dissector and Wax Packer, Double-Ended	7¾ in 197 mm
65-1018	4	Slightly Curved Dissector, Light	8¼ in 210 mm
65-1019	5	Slightly Curved Blunt Dissector, Double-Ended	11½ in 272 mm



65-1015

# Dissectors

## Penfield Dissector

CODE	SIZE	DESCRIPTION	LENGTH
67-7410	1	Broad Curved Dissector, and Sharp Round Spoon, Double-Ended	12 ½ in 318 mm
67-7412	2	Slightly Curved Dissector, and Wax Packer, Double-Ended	12 ½ in 318 mm
67-7414	3	Full Curved Dissector and Wax Packer, Double-Ended	12 ½ in 318 mm
67-7416	4	Slightly Curved Dissector, Light	12 ½ in 318 mm
67-7418	5	Slightly Curved Blunt Dissector, Double-Ended	12 ½ in 318 mm
67-7411	1	Broad Curved Dissector, and Sharp Round Spoon, Double-Ended	13 ½ in 343 mm
67-7413	2	Slightly Curved Dissector, and Wax Packer, Double-Ended	13 ½ in 343 mm
67-7415	3	Full Curved Dissector and Wax Packer, Double-Ended	13 ½ in 343 mm
67-7417	4	Slightly Curved Dissector, Light	13 ½ in 343 mm
67-7419	5	Slightly Curved Blunt Dissector, Double-Ended	13 ½ in 343 mm



## Penfield Dissector

CODE	DESCRIPTION	LENGTH
46-3139	Lumbar #1	9 ½ in 241 mm
46-3140	Lumbar #2	9 ½ in 241 mm
46-3142	Lumbar #4	9 ½ in 241 mm



SPINE

## Dissectors

### Magnafree Penfield Dissector

CODE	SIZE	DESCRIPTION	LENGTH
65-2402	1	Broad Curved Dissector, and Sharp Round Spoon, Double-Ended	7 in 178 mm
65-2403	2	Slightly Curved Dissector, and Wax Packer, Double-Ended	7¾ in 197 mm
65-2404	3	Fully Curved Dissector and Wax Packer, Double-Ended	7¾ in 197 mm
65-2405	4	Slightly Curved Dissector, Light Length	8¼ in 210 mm

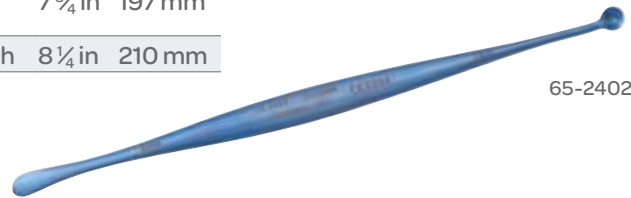

65-2402

## Distractors (Cervical)

### Caspar Cervical Vertebral Body Multi-Level Distractor

Stainless Steel

CODE	DESCRIPTION
57-5116	Left
57-5115	Right



57-5116

### Cervical Distractor

Stainless Steel

CODE	TIP SIZE
57-5695	Left Drill Guide
57-5694	Right Drill Guide

Image Not Available



## Distractors (Pin)

### Caspar Distraction Pin

Stainless Steel

CODE	DESCRIPTION
57-5108	16 mm

Image Not Available



## Distractors

### Caspar Distractor Only

Stainless Steel

CODE	DESCRIPTION
57-5101	Left
57-5105	Right



57-5101

## Dowel Instruments (Anterior Cervical)

### Guard Guide

Stainless Steel

CODE	DESCRIPTION	LENGTH
14-1043	Small $\frac{3}{8}$ in (9.5 mm)	7 $\frac{1}{2}$ in 191 mm
14-1044	Large $\frac{1}{2}$ in (13 mm)	7 $\frac{1}{2}$ in 191 mm



14-1043

## Dowel Instruments (Cutters)

### Dowel Cutter

Stainless Steel

CODE	DESCRIPTION
56-1005	12 mm
56-1006	14 mm
56-1007	16 mm
56-1008	18 mm



56-1005

## Dowel Instruments (Cutter Shaft)

### Dowel Cutter Shaft

CODE	DESCRIPTION	LENGTH
11-1019	Cutter Shaft	6½ in 165 mm



## Dowel Instruments (Ejector)

### Dowel Ejector

CODE	DESCRIPTION	LENGTH
80-1001	Ejector	4½ in 114 mm



## Dowel Instruments (Handle)

### Crossbar Handle

CODE	DESCRIPTION
11-1002	Two each



## Dowel Instruments (Pin)

### Dowel Pin

Center Pins

CODE	DESCRIPTION
47-1010	12 mm
47-1011	14 mm
47-1012	16 mm
47-1013	18 mm



## Drills (ACF)

### Ultra ACF Side Loading Twist Drill

CODE
59-0112



### Ultra ACF Twist Drill

CODE
59-0109



## Drills (Cervical)

### Cervical Drill Tip

CODE	DESCRIPTION
26-1265	10 mm
26-1266	12 mm
26-1267	14 mm
26-1268	16 mm



## Drills (Guard Cap)

### Drill Guard Cap

CODE	DIAMETER	LENGTH
12-1007	1 in 25 mm	1¼ in 32 mm



## Drills (Shaft)

### Drill Shaft

CODE	DESCRIPTION	LENGTH
28-1001	Small (13 mm)	5⅞ in 141 mm
28-1002	Large (16 mm)	5⅞ in 141 mm



28-1001

## Drills (Twist)

### Caspar Twist Drill Bit

CODE	LENGTH
57-5111	5¾ in 145 mm



## Drivers (Anterior Cervical)

### Anterior Cervical Graft Driver

CODE	DESCRIPTION	TIP THICKNESS		LENGTH
46-3026	Guarded	$\frac{1}{4}$ in	6.5 mm	$8\frac{3}{4}$ in 222 mm
46-3028	Unguarded	$\frac{5}{16}$ in	7 mm	$8\frac{3}{4}$ in 222 mm

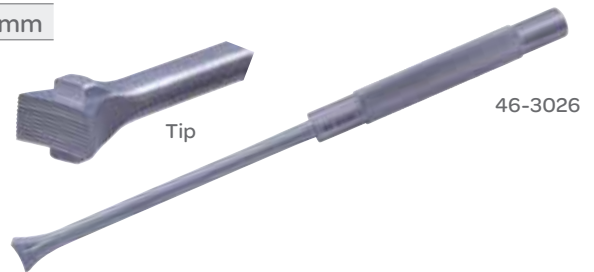

## Drivers (Lumbar)

### Lumbar Graft Driver

CODE	DESCRIPTION	TIP THICKNESS		LENGTH
46-3027	Unguarded	$\frac{3}{8}$ in	10 mm	$8\frac{3}{4}$ in 222 mm

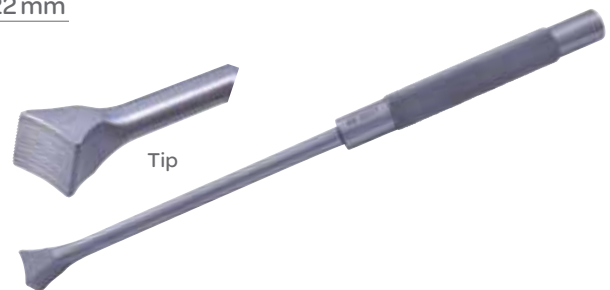

## Drivers (Screw Driver)

### Caspar Screw Driver

CODE	DESCRIPTION	LENGTH
57-5109	Screw Driver	8 in 203 mm





## Elevators

### Woodson Elevator-Spatula

Double-Ended

CODE	DESCRIPTION	BLADE (W X D)	LENGTH
59-1000	Semi-Sharp	$\frac{1}{8}$ x $\frac{1}{2}$ in 3 x 13 mm	10 in 254 mm

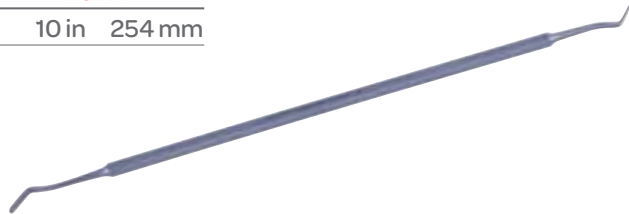

## Elevators (Nerve Root)

### McCulloch Nerve Root Elevator

Blunt, Double-Ended

CODE	BLADE WIDTH	LENGTH
57-5763	5.6 mm Both Ends	9 in 229 mm



## Elevators (Osteophyte)

### Osteophyte Periosteal Elevator

CODE	DESCRIPTION	LENGTH
57-5038	Elevator	8 in 203 mm
65-1064	Elevator	8 in 203 mm



57-5038

## Elevators (Periosteal)

### Adson Periosteal Elevator

CODE	DESCRIPTION	BLADE WIDTH	LENGTH
65-1033	No. 4, Straight, Semi-Sharp Edge	$\frac{5}{16}$ in 8 mm	$6\frac{1}{2}$ in 165 mm
65-1030	No. 1, Chisel Edge	$\frac{5}{16}$ in 8 mm	$6\frac{1}{2}$ in 165 mm
65-1031	No. 2, Curved, Blunt Edge	$\frac{1}{4}$ in 6 mm	$6\frac{1}{2}$ in 165 mm
65-1032	No. 3, Curved, Semi-Sharp Edge	$\frac{1}{4}$ in 6 mm	$6\frac{1}{2}$ in 165 mm

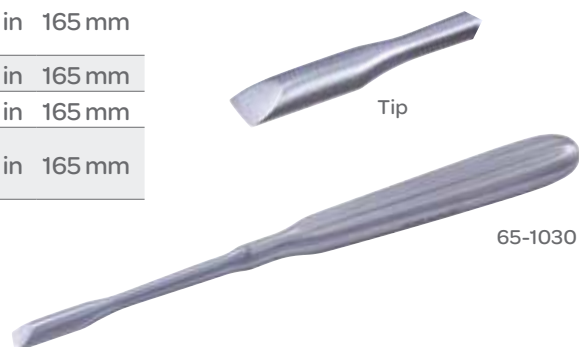

### Carroll Periosteal Elevator

CODE	DESCRIPTION	BLADE WIDTH	LENGTH
65-2549	Double-Ended	$\frac{1}{8}$ in 3 mm $\frac{3}{8}$ in 10 mm	$5\frac{1}{2}$ in 140 mm



### Chandler Elevator

CODE	DESCRIPTION	TIP SIZE	LENGTH
26-5621	Blunt	8 x 13 mm	$7\frac{1}{2}$ in 191 mm
26-5622	Blunt	12 x 19 mm	8 in 203 mm
26-5623	Blunt	17 x 25 mm	9 in 229 mm
26-5624	Blunt	19 x 30 mm	10 in 254 mm



### Cloward Periosteal Elevator

CODE	DESCRIPTION	TIP WIDTH	LENGTH
26-2777	#4	12 mm	$7\frac{3}{4}$ in 197 mm



## Elevators (Periosteal)

### Cobb Elevator

Sharp Rounded Edge

CODE	DESCRIPTION	LENGTH
67-7028	$\frac{3}{8}$ in 10 mm	12 in 305 mm
67-7030	$\frac{1}{2}$ in 13 mm	12 in 305 mm
67-7032	$\frac{3}{4}$ in 19 mm	12 in 305 mm
67-7029	$\frac{3}{8}$ in 10 mm	13 in 330 mm
67-7031	$\frac{1}{2}$ in 13 mm	13 in 330 mm
67-7033	$\frac{3}{4}$ in 19 mm	13 in 330 mm

Image Not Available



### Cobb Elevator

CODE	WIDTH	LENGTH
26-5023	$\frac{1}{2}$ in 13 mm	14 in 356 mm
26-5020	$\frac{5}{8}$ in 15 mm	14 in 356 mm
26-5021	$\frac{3}{4}$ in 19 mm	14 in 356 mm
26-5022	1 in 25 mm	14 in 356 mm

Image Not Available



### Cottle Elevator

CODE	DESCRIPTION	LENGTH
26-2766	Double-Ended	$8\frac{7}{8}$ in 225 mm

Image Not Available



### Cottle-McKenty Elevator

CODE	LENGTH
26-4226	$8\frac{1}{2}$ in 216 mm

Image Not Available



## Elevators (Periosteal)

### Crego Elevator

Blunt

CODE	DESCRIPTION	TIP WIDTH	LENGTH
26-5500	Full Curve	15 mm	7½ in 191 mm
26-5503	Slight Curve	7 mm	8 in 203 mm

Image Not Available



### Cushing "Little Joker" Periosteal Elevator

Blunt

CODE	DESCRIPTION	LENGTH
26-6201	Round Edge	7½ in 181 mm
26-6203	"Little Joker"	7½ in 191 mm



26-6201

### Cushing "Little Joker" Periosteal Elevator

CODE	DESCRIPTION	BLADE WIDTH	LENGTH
65-1047	Hollow Handle	¼ in 6 mm	6 in 152 mm
65-1048	Solid Handle	¼ in 6 mm	7½ in 191 mm
65-1050	Narrow, Sharp	¼ in 6 mm	8½ in 206 mm
65-1075	Rounded Edge, Sharp, Wide	⅝ in 16 mm	7¼ in 185 mm
65-1076	Square Edge, Sharp, Wide	⅝ in 16 mm	7¼ in 185 mm



65-1047

### Cushing "Little Joker" Periosteal Elevator

CODE	DESCRIPTION	BLADE WIDTH	LENGTH
67-7034	Sharp Rounded Edge	⅝ in 16 mm	9½ in 241 mm
67-7035	Sharp Rounded Edge	⅝ in 16 mm	10½ in 266 mm
67-7036	Sharp Square Edge	⅝ in 16 mm	9½ in 241 mm
67-7037	Sharp Square Edge	⅝ in 16 mm	10½ in 266 mm

Image Not Available



## Elevators (Periosteal)

### Hoen Periosteal Elevator

CODE	DESCRIPTION	BLADE WIDTH	LENGTH
65-1001	No. 1	$\frac{5}{16}$ in 8 mm	7 in 178 mm
65-1002	No. 2	$\frac{5}{8}$ in 15 mm	7 $\frac{1}{4}$ in 185 mm
65-1003	No. 3	$\frac{3}{4}$ in 20 mm	7 $\frac{1}{2}$ in 191 mm



65-1002

### Iowa University Periosteal Elevator

CODE	BLADE WIDTH	LENGTH
65-1080	1 $\frac{1}{16}$ in 17 mm	7 $\frac{1}{4}$ in 185 mm



65-1080

### Joseph Periosteal Elevator

CODE	DESCRIPTION	LENGTH
26-4404	Light Curve, Sharp	6 $\frac{1}{2}$ in 165 mm

Image Not Available



## Elevators (Periosteal)

### Key Periosteal Elevator

CODE	DESCRIPTION	WIDTH	LENGTH
26-5604	Slight Curve	$\frac{1}{8}$ in	$7\frac{1}{2}$ in 191 mm
26-5606	Slight Curve	$\frac{1}{4}$ in	$7\frac{1}{2}$ in 191 mm
26-5612	Slight Curve	$\frac{1}{2}$ in	$7\frac{1}{2}$ in 191 mm
26-5620	Slight Curve	$\frac{3}{4}$ in	$7\frac{1}{2}$ in 191 mm
26-5625	Slight Curve	1 in	$7\frac{1}{2}$ in 191 mm



26-5606

### Key Periosteal Elevator

CODE	DESCRIPTION	BLADE WIDTH	LENGTH
65-2510	Elevator	$\frac{1}{4}$ in 6 mm	$7\frac{1}{2}$ in 191 mm
65-2511	Elevator	$\frac{3}{8}$ in 10 mm	$7\frac{1}{2}$ in 191 mm
65-2512	Elevator	$\frac{1}{2}$ in 13 mm	$7\frac{1}{2}$ in 191 mm
65-2513	Elevator	$\frac{3}{4}$ in 19 mm	$7\frac{1}{2}$ in 191 mm



65-2510

### Lane Elevator

CODE	DESCRIPTION	BLADE WIDTH	LENGTH
26-1411	Blunt	6 mm	$6\frac{3}{4}$ in 171 mm
26-1412	Blunt	10 mm	$6\frac{3}{4}$ in 171 mm



Image Not Available

### Langenbeck Periosteal Elevator

CODE	DESCRIPTION	BLADE WIDTH	LENGTH
65-1115	Narrow	$\frac{1}{4}$ in 6 mm	$8\frac{1}{2}$ in 210 mm
65-1116	Wide	$\frac{1}{16}$ in 17 mm	$7\frac{1}{2}$ in 191 mm



65-1116

## Elevators (Periosteal)



46-3425

### Magnum Cobb Elevator Set

Set of Six Cobb Elevators, Straight

CODE	DESCRIPTION	WORKING DISTANCE		HANDLE DIAMETER		HANDLE LENGTH		LENGTH	
46-3425	Set includes:								
46-3426	10 m	4 <sup>7</sup> / <sub>10</sub> in	119 mm	1 <sup>3</sup> / <sub>25</sub> in	28 mm	7 <sup>4</sup> / <sub>5</sub> in	198 mm	12 <sup>3</sup> / <sub>5</sub> in	320 mm
46-3427	15 m	4 <sup>7</sup> / <sub>10</sub> in	119 mm	1 <sup>3</sup> / <sub>25</sub> in	28 mm	7 <sup>4</sup> / <sub>5</sub> in	198 mm	12 <sup>3</sup> / <sub>5</sub> in	320 mm
46-3428	20 m	4 <sup>7</sup> / <sub>10</sub> in	119 mm	1 <sup>3</sup> / <sub>25</sub> in	28 mm	7 <sup>4</sup> / <sub>5</sub> in	198 mm	12 <sup>3</sup> / <sub>5</sub> in	320 mm
46-3429	25 m	4 <sup>7</sup> / <sub>10</sub> in	119 mm	1 <sup>3</sup> / <sub>25</sub> in	28 mm	7 <sup>4</sup> / <sub>5</sub> in	198 mm	12 <sup>3</sup> / <sub>5</sub> in	320 mm
46-3430	30 m	4 <sup>7</sup> / <sub>10</sub> in	119 mm	1 <sup>3</sup> / <sub>25</sub> in	28 mm	7 <sup>4</sup> / <sub>5</sub> in	198 mm	12 <sup>3</sup> / <sub>5</sub> in	320 mm
46-3431	35 m	4 <sup>7</sup> / <sub>10</sub> in	119 mm	1 <sup>3</sup> / <sub>25</sub> in	28 mm	7 <sup>4</sup> / <sub>5</sub> in	198 mm	12 <sup>3</sup> / <sub>5</sub> in	320 mm

## Elevators (Periosteal)

### McCulloch-Cobb Elevator

Semi-Sharp Blade

CODE	DEPTH	LENGTH
57-5613	13 mm	10 ½ in 267 mm
57-5619	19 mm	10 ½ in 267 mm

Image Not Available



### McKenty Periosteal Elevator

CODE	DESCRIPTION	LENGTH
26-4224	Light Curve, Sharp, 4 mm	6 in 152 mm
26-4225	Light Curve, Sharp, 5 mm	6 in 152 mm

Image Not Available



### Molt Periosteal Elevator

CODE	DESCRIPTION	LENGTH
32-3420	#9	7 ¼ in 185 mm
26-3700	#9	7 ¼ in 185 mm

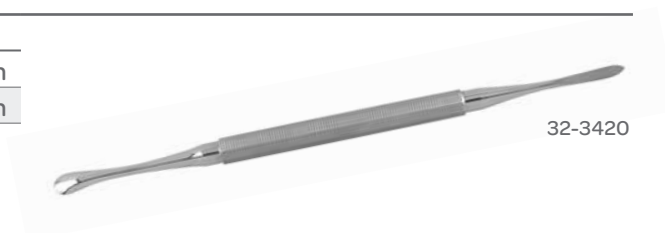

32-3420

### Periosteal Elevator

Phenolic Handle

CODE	DESCRIPTION	TIP WIDTH	LENGTH
26-4450	Straight	3 mm	7 ¼ in 184 mm
26-4452	Straight	6 mm	7 ¼ in 184 mm
26-4458	Straight	20 mm	7 ¼ in 184 mm
26-4454	Straight	14 mm	7 ¾ in 197 mm
26-4457	Curved	13 mm	7 ¼ in 184 mm
26-4455	Curved	14 mm	7 ¾ in 197 mm
26-4453	Sharp, Round Edge	6 mm	7 ¼ in 184 mm



26-4457



## Elevators (Periosteal)

### Periosteal Elevator

Sharp

CODE	DESCRIPTION	TIP WIDTH	LENGTH
65-1056	No. 1	$\frac{3}{16}$ in 5 mm	8 in 203 mm
65-1057	No. 2	$\frac{1}{4}$ in 6.4 mm	8 in 203 mm
65-1058	No. 3	$\frac{5}{16}$ in 8 mm	8 in 203 mm
65-1059		$\frac{15}{32}$ in 12 mm	8 in 203 mm



65-1056

### Sayre Periosteal Elevator

CODE	DESCRIPTION	LENGTH
26-3750	Sharp	6½ in 165 mm
26-3751	Blunt	6½ in 165 mm

Image Not Available



### Sedillot Periosteal Elevator

CODE	DESCRIPTION	TIP WIDTH	LENGTH
26-4738	Sharp	18 mm	7½ in 191 mm

Image Not Available



### Sharp Periosteal Elevator

CODE	DESCRIPTION	LENGTH
65-1121	$\frac{3}{16}$ in	8 in 203 mm



## Elevators (Periosteal)

### Woodson Elevator

Spatula

CODE	DESCRIPTION	LENGTH
57-3515	Double-Ended	7½ in 181 mm
67-7039	Double-Ended	12 in 305 mm

Image Not Available



## Elevators (Spinal)

### Cobb Spinal Elevator

CODE	BLADE WIDTH	LENGTH
26-4910	⅜ in 9.5 mm	11 in 279 mm
26-4913	½ in 12.7 mm	11 in 279 mm
26-4919	¾ in 19 mm	11 in 279 mm
26-4925	1 in 25 mm	11 in 279 mm
26-4930	1¼ in 31 mm	11 in 279 mm
26-4949	1¾ in 44 mm	11 in 279 mm

Image Not Available



### Cobb Spinal Elevator

Hexagonal Handle

CODE	WIDTH	LENGTH
26-5001	⅜ in 9.5 mm	9½ in 241 mm
26-5002	½ in 12.7 mm	9½ in 241 mm
26-5003	¾ in 19 mm	9½ in 241 mm
26-5004	1 in 25 mm	9½ in 241 mm
26-5005	1¼ in 31 mm	9½ in 241 mm

Image Not Available



### Cobb Spinal Elevator

CODE	BLADE WIDTH	LENGTH
65-2545	⅜ in 10 mm	11 in 279 mm
65-2546	½ in 13 mm	11 in 279 mm
65-2547	¾ in 19 mm	11 in 279 mm



65-2545

## Elevators (Spinal)

### Karlin XL Magnum Cobb Elevator

CODE	WIDTH	LENGTH
46-3242	15 mm	13¼ in 337 mm
46-3243	20 mm	13¼ in 337 mm
46-3244	25 mm	13¼ in 337 mm
46-3245	30 mm	13¼ in 337 mm
46-3246	35 mm	13¼ in 337 mm



46-3242

## Elevators

### Klein-Kutz Elevator and Dissector

CODE	DESCRIPTION	LENGTH
20-1788	Double-Ended, 2 mm and 3 mm Tips, Sharp	7½ in 191 mm

Image Not Available



## Files (Bone)

### Bone File

Double-Ended

CODE	DESCRIPTION	LENGTH
26-1350	5 mm and 7 mm	7¼ in 184 mm
26-1428	2-Sided Convex and Flat, Single-Ended, Tapers from 6 - 23 mm	11 in 279 mm
26-1450	Single-Ended, 15 mm wide	9½ in 241 mm

Image Not Available



## Forceps (ACF)

### Ultra ACF Bone Graft Harvesting Forceps

CODE	DESCRIPTION
59-0124	7 mm

Image Not Available



## Forceps (Bone Cutting)

### Horsley Bone Cutting Forceps

Double Action

CODE	DESCRIPTION	LENGTH
30-1298	Curved Shaft, Angular Jaw	10 ½ in 267 mm

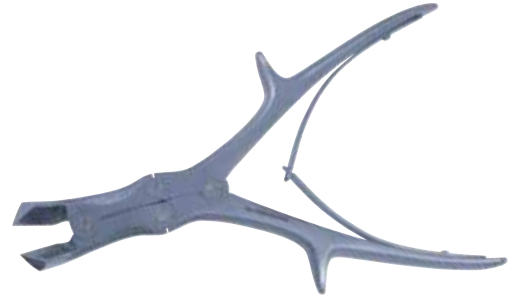

### Liston Bone Cutting Forceps

CODE	DESCRIPTION	LENGTH
30-1310	Straight	5 ½ in 140 mm



### Ruskin Bone Cutting Forceps

CODE	DESCRIPTION	LENGTH
30-1290	Double-Action	7 ¼ in 185 mm

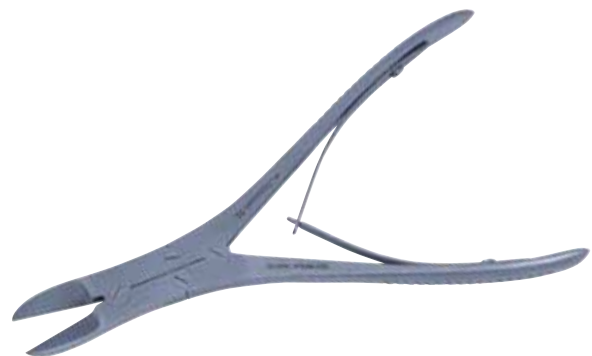

## Forceps (Bone Cutting)

### Stille-Liston Bone Forceps

Double Action

CODE	DESCRIPTION	LENGTH
30-1295	Straight	10 ½ in 267 mm
30-1296	Curved	10 ½ in 267 mm



30-1295

## Forceps (Bone Rongeur)

### Stille-Luer Bone Rongeur

CODE	DESCRIPTION	LENGTH
31-3023	Double-Action, Jaws 10 mm Wide, Straight	9 in 229 mm



## Forceps (Dressing)

### Cushing Dressing Forceps

CODE	DESCRIPTION	TIP WIDTH	LENGTH
30-1203	Serrated, Bayonet	2.1 mm	3 ¼ in 140 mm



## Forceps (Dressing)

### Williams Microlumbar Forceps

CODE	DESCRIPTION	LENGTH
80-1654	Single Tooth Cup, 2 mm Bite Size	5½ in 140 mm



## Forceps (Ligament)

### Crockard Ligament Grasping Forceps

CODE	LENGTH
50-1663	10 in 254 mm



## Forceps (Ligamentum Flavum)

### Ligamentum Flavum Forceps

CODE	DESCRIPTION	LENGTH
30-1228	Curved on Side, 1x2 Teeth	7¼ in 184 mm



## Forceps (Odontoid Peg)

### Crockard Odontoid Peg Grasping Forceps

CODE	LENGTH
50-1662	9 in 229 mm



## Gauges (ACF)

### Ultra ACF Color Coded Depth Gauge

CODE	DESCRIPTION	LENGTH
59-0106	Cervical Spine Depth Gauge	

Image Not Available



## Gauges (Cervical Spanner)

### Karlin Cervical Spanner

Cervical Spanner Set of six (6) with case. Designed to directly measure the height of the interspace, access soft tissue tension and distract the interspace.

CODE	DESCRIPTION	SPANNER WIDTH
46-3040	Set Includes:	
46-3041	Cervical Spanner	5 mm
46-3042	Cervical Spanner	6 mm
46-3043	Cervical Spanner	7 mm
46-3044	Cervical Spanner	8 mm
46-3045	Cervical Spanner	9 mm
46-3046	Cervical Spanner	10 mm
46-3047	Cervical Spanner Case	



46-3040

## Gauges (Depth)

### Depth Gauge

CODE	LENGTH
39-1012	8 <sup>3</sup> / <sub>8</sub> in 213 mm



## Gauges (Spinal)

### LW Gauge

CODE	DESCRIPTION
39-1015	Designed to be used anywhere on the Spine to measure the length and width of a space.



## Gouges

### Alexander Gouge

CODE	TIP WIDTH	LENGTH
28-2804	4 mm	7 in 178 mm
28-2806	6 mm	7 in 178 mm
28-2808	8 mm	7 in 178 mm
28-2814	14 mm	7 in 178 mm





## Gouges

### Bishop Gouge

CODE	TIP WIDTH	LENGTH
27-6063	3 mm	6 in 381 mm



### Hibbs Gouge

CODE	DESCRIPTION	TIP WIDTH	LENGTH
28-5256	Curved	¼ in 6 mm	9½ in 241 mm
28-5260	Curved	⅜ in 10 mm	9½ in 241 mm
28-5262	Curved	½ in 12 mm	9½ in 241 mm
28-5266	Curved	⅝ in 16 mm	9½ in 241 mm
28-5270	Curved	¾ in 20 mm	9½ in 241 mm
28-5275	Curved	1 in 25 mm	9½ in 241 mm
28-5280	Curved	1⅛ in 30 mm	9½ in 241 mm
28-5290	Curved	1½ in 38 mm	9½ in 241 mm

Image Not Available



### Hibbs Gouge

CODE	DESCRIPTION	TIP WIDTH	LENGTH
28-5206	Straight	¼ in 6 mm	9½ in 241 mm
28-5210	Straight	⅜ in 10 mm	9½ in 241 mm
28-5212	Straight	½ in 12 mm	9½ in 241 mm
28-5216	Straight	⅝ in 16 mm	9½ in 241 mm
28-5220	Straight	¾ in 20 mm	9½ in 241 mm
28-5225	Straight	1 in 25 mm	9½ in 241 mm
28-5240	Straight	1½ in 38 mm	9½ in 241 mm

Image Not Available



### Stille Gouge

CODE	DESCRIPTION	TIP WIDTH	LENGTH
28-4512	Straight	12 mm	8 in 203 mm
28-4515	Straight	15 mm	8 in 203 mm
28-4525	Straight	25 mm	8 in 203 mm

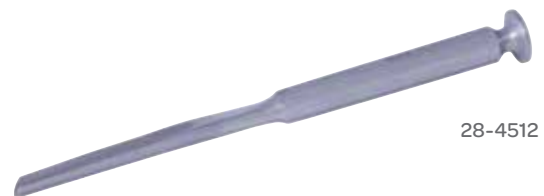

28-4512

### Swan Neck Gouge

CODE	LENGTH
28-6255	9 in 229 mm

Image Not Available



## Gouges (Bone)

### Bone Gouge

CODE	DESCRIPTION	TIP WIDTH	LENGTH
32-2010	Curved	¼ in 6 mm	11 in 279 mm
32-2011	Curved	⅜ in 10 mm	11 in 279 mm
32-2012	Curved	½ in 13 mm	11 in 279 mm
32-2013	Curved	⅝ in 16 mm	11 in 279 mm
32-2014	Curved	¾ in 19 mm	11 in 279 mm
32-2015	Curved	1 in 25 mm	11 in 279 mm
32-2016	Curved	1¼ in 32 mm	11 in 279 mm

Image Not Available



### Bone Gouge

CODE	DESCRIPTION	TIP WIDTH	LENGTH
32-2000	Straight	¼ in 6 mm	11 in 279 mm
32-2001	Straight	⅜ in 10 mm	11 in 279 mm
32-2002	Straight	½ in 13 mm	11 in 279 mm
32-2003	Straight	⅝ in 16 mm	11 in 279 mm
32-2004	Straight	¾ in 19 mm	11 in 279 mm
32-2005	Straight	1 in 25 mm	11 in 279 mm
32-2006	Straight	1¼ in 32 mm	11 in 279 mm



32-2001

### Cobb Spinal Gouge

CODE	DESCRIPTION	TIP WIDTH	LENGTH
32-2660	Straight	¼ in 6 mm	11 in 279 mm
32-2661	Lesser Curve	¼ in 6 mm	11 in 279 mm
32-2662	Full Curve	¼ in 6 mm	11 in 279 mm
32-2663	Reverse Curve	¼ in 6 mm	11 in 279 mm

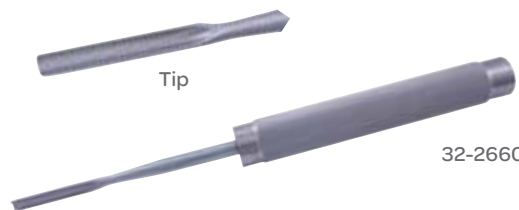

Tip

32-2660

### Smith-Peterson Bone Gouge

CODE	DESCRIPTION	TIP WIDTH	LENGTH
32-2550	Curved	¼ in 6 mm	8 in 203 mm
32-2551	Curved	⅜ in 10 mm	8 in 203 mm
32-2552	Curved	½ in 13 mm	8 in 203 mm
32-2553	Curved	⅝ in 16 mm	8 in 203 mm
32-2554	Curved	¾ in 19 mm	8 in 203 mm
32-2555	Curved	1 in 25 mm	8 in 203 mm
32-2556	Curved	1¼ in 32 mm	8 in 203 mm

Image Not Available



## Gouges (Bone)

### Smith-Peterson Bone Gouge

CODE	DESCRIPTION	TIP WIDTH		LENGTH	
32-2540	Straight	¼ in	6 mm	8 in	203 mm
32-2541	Straight	⅜ in	10 mm	8 in	203 mm
32-2542	Straight	½ in	13 mm	8 in	203 mm
32-2543	Straight	⅝ in	16 mm	8 in	203 mm
32-2544	Straight	¾ in	19 mm	8 in	203 mm
32-2545	Straight	1 in	25 mm	8 in	203 mm
32-2546	Straight	1¼ in	32 mm	8 in	203 mm

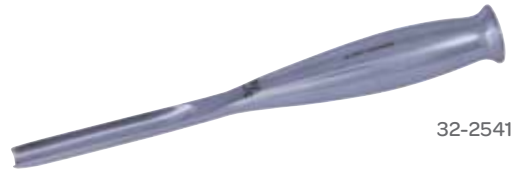

32-2541

## Gouges (Spinal)

### Cobb Spinal Gouge

CODE	DESCRIPTION	LENGTH	
25-8011	Straight	11 in	279 mm
28-8012	Medium Curve	11 in	279 mm
28-8013	Strong Curve	11 in	279 mm
28-8014	Reverse Curve	11 in	279 mm

Image Not Available



## HOLDERS (Bone Graft)

### Ultra Bone Graft Holder

CODE
59-0131



## Hooks

### Scoville Hook

CODE	DESCRIPTION	LENGTH	
13-1004C	Laminectomy Hook	2 in	51 mm
13-1005C	Laminectomy Hook	3 in	76 mm

Image Not Available



## Hooks (Adson)

### Adson Dissecting Hook

CODE	DESCRIPTION	HOOK DIAMETER	LENGTH	
67-7428	Sharp	5 mm	10 in	254 mm
67-7429	Blunt	5 mm	10 in	254 mm

Image Not Available



## Hooks (Bone)

### Bone Hook

CODE	DESCRIPTION	HOOK DIAMETER	LENGTH	
32-3422	Sharp, Large	60 mm	8 ½ in	216 mm
32-3423	Sharp, Heavy Duty	19 mm	9 in	229 mm
32-3425	Sharp, Heavy Duty	30 mm	9 in	229 mm
32-3424	Blunt, Heavy Duty	19 mm	9 in	229 mm



32-3422

## Hooks (Dural)

### Dural Hook

CODE	TIP DIAMETER	LENGTH
38-1038	2 mm	6 ½ in 165 mm



## Hooks (Ganglion)

### Cushing Gasserian Ganglion Hook

CODE	DESCRIPTION	HOOK DEPTH		LENGTH	
38-1030	Blunt	$\frac{3}{16}$ in	5 mm	9 in	229 mm
67-7430	Blunt	$\frac{3}{16}$ in	5 mm	11 in	280 mm

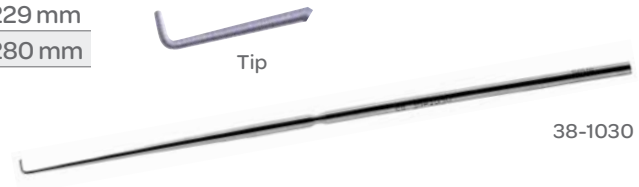

## Hooks (Nerve)

### Dandy Nerve Hook

CODE	DESCRIPTION	TIP LENGTH	LENGTH	
67-7431	Straight, Blunt	3 mm	10 in	254 mm

Image Not Available

### Hoehn Nerve Hook

CODE	DESCRIPTION	TIP LENGTH	LENGTH	
67-7432	Straight	$\frac{1}{4}$ in	7 mm	10 in 254 mm

Image Not Available

### Hook

Titanium

CODE	DESCRIPTION	TIPLength		LENGTH	
67-7433	Ball Tip	3 mm		10 in	254 mm
67-7434	Blunt Tip	2 mm		10 in	254 mm
67-7435	Blunt Tip	3 mm		10 in	254 mm

Image Not Available

### Lumbar Nerve Hook

CODE	LENGTH
46-3141	$9\frac{1}{2}$ in 241 mm

Image Not Available

## Hooks (Nerve)

### Rhoton Nerve Hook

Titanium

CODE	DESCRIPTION	TIP LENGTH	LENGTH
67-7437	#10 Blunt, 90°	1 mm	10 in 254 mm
67-7436	#9 Semi Sharp, 90°	1 mm	10 in 254 mm
67-7438	#11 Semi-Sharp, 40°	3 mm	10 in 254 mm



### XL Cervical Micro Nerve Hook

CODE	WORKING DISTANCE	TOTAL LENGTH
46-2647	4 1/10 in 104 mm	9 1/2 in 240 mm

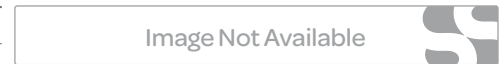

### XL Cervical Micro Nerve Hook

CODE	WORKING DISTANCE	TOTAL LENGTH
46-2646	4 1/10 in 104 mm	9 1/2 in 240 mm



## Impactors

### Graft Impactor

Double-Ended

CODE	END DIAMETER	LENGTH
28-1000	7/16 in 11 mm	8 3/4 in 222 mm
	9/16 in 14 mm	



### Offset Central Impactor

CODE
46-3007



## Impactors (Bone Graft)

### Bone Graft Impactor and Holder

CODE	LENGTH
28-1003	8 <sup>3</sup> / <sub>4</sub> in 222 mm



## Impactors (Central Canal)



### Central Canal Impactor

Used to impact symptomatic spondylophytes, placed beneath and clear of neurostructures. Slip resistant, textured impaction surface is held perpendicular to surrounding bone planes and impacted with a mallet.

CODE	DESCRIPTION	TIP WIDTH	TIP LENGTH	LENGTH
46-3008	Tip oriented 30° from vertical	<sup>7</sup> / <sub>32</sub> in 7 mm	<sup>1</sup> / <sub>2</sub> in 13 mm	8 <sup>3</sup> / <sub>4</sub> in 222 mm

### Micro Offset Central Canal Impactor

CODE	TIP WIDTH	LENGTH
46-3021	4 mm	7 in 178 mm



## Impactors (Lateral Gutter)

### Lateral Gutter Impactor

CODE	TIP WIDTH	TIP DEPTH	LENGTH	
46-3009	13 mm	5 mm	7 in	178 mm



## Impactors (Lumbar and Cervical)

### Lumbar and Cervical Impactor/Graft Driver

CODE	DESCRIPTION	HEAD	LENGTH	
57-5248	Micro Lateral	4.8 x 10 mm	8 ½ in	216 mm
57-5243	Wide	10 x 13 mm	8 ½ in	216 mm
57-5244	Offset	6.5 x 11.5 mm	8 ½ in	216 mm
57-5246	Narrow	6 x 12.5 mm	8 ½ in	216 mm



57-5246



## Kits (Anterior Fusion)



### Anterior Fusion Kit

For Removal of Ruptured Cervical Disc Lesions and Osteophytes by an Anterior Surgical Approach

CODE	DESCRIPTION	DIAMETER	QUANTITY
80-1004	Kit with Case Includes (Below):		
21-1001	Instrument Case		
11-1002	Cross Bar Handle		2
56-1005	Dowel Cutter	12 mm	
56-1006	Dowel Cutter	14 mm	
56-1007	Dowel Cutter	16 mm	
56-1008	Dowel Cutter	18 mm	
47-1010	Dowel Cutter Center Pins	12 mm	
47-1011	Dowel Cutter Center Pins	14 mm	
47-1012	Dowel Cutter Center Pins	16 mm	
47-1013	Dowel Cutter Center Pin	18 mm	
11-1019	Dowel Cutter Shaft		
80-1001	Dowel Ejector		
11-1011	Dowel Handle and Ejector		
26-1265	Drill Tips, 10 mm		
26-1266	Drill Tips, 12 mm		
26-1267	Drill Tips, 14 mm		
26-1268	Drill Tips, 16 mm		
12-1005C	Cervical Drill Guards, Small		
12-1006C	Cervical Drill Guards, Large		
12-1007	Drill Guard Cap		
28-1001	Drill Shaft, Small		
28-1002	Drill Shaft, Large		
65-1064	Osteophyte Periosteal Elevator		
39-1012	Depth Gauge		
14-1043	Guard Guide, Double-Ended, Small		
14-1044	Guard Guide, Double-Ended, Large		
61-1004	Vertebra Spreader		
80-1012	Spanner Wrench		

## Kits (Cervical Retractor)



### Ultra ReVeal ACF Distraction System

Complete System: Tray One of Three

CODE	DESCRIPTION	COLOR	LENGTH	QUANTITY
59-0000	Complete ACF Retractor System			1
59-0030	ACF Blade, Blunt	Silver	1 $\frac{1}{8}$ in 30 mm	2
59-0031	ACF Blade, Blunt	Blue	1 $\frac{3}{8}$ in 35 mm	2
59-0032	ACF Blade, Blunt	Red	1 $\frac{5}{8}$ in 40 mm	2
59-0033	ACF Blade, Blunt	Green	1 $\frac{3}{4}$ in 45 mm	2
59-0034	ACF Blade, Blunt	Violet	2 in 50 mm	2
59-0035	ACF Blade, Blunt	Black	2 $\frac{1}{8}$ in 55 mm	2
59-0036	ACF Blade, Blunt	Gold	2 $\frac{3}{8}$ in 60 mm	2
59-0037	ACF Blade, Blunt	Navy	2 $\frac{1}{2}$ in 65 mm	2
59-0038	ACF Blade, Blunt	Light Green	2 $\frac{3}{4}$ in 70 mm	2
59-0039	ACF Blade, Blunt	Orange	3 in 75 mm	2
59-0080	ACF Micro Blade, Blunt	Blue	$\frac{9}{16}$ x 1 $\frac{3}{8}$ in 14 x 35 mm	2
59-0081	ACF Micro Blade, Blunt	Red	$\frac{9}{16}$ x 1 $\frac{5}{8}$ in 14 x 40 mm	2
59-0082	ACF Micro Blade, Blunt	Green	$\frac{9}{16}$ x 1 $\frac{3}{4}$ in 14 x 45 mm	2
59-0083	ACF Micro Blade, Blunt	Violet	$\frac{9}{16}$ x 2 $\frac{1}{8}$ in 14 x 50 mm	2
59-0084	ACF Micro Blade, Blunt	Black	$\frac{9}{16}$ x 2 $\frac{1}{8}$ in 14 x 55 mm	2
59-0085	ACF Micro Blade, Blunt	Gold	$\frac{9}{16}$ x 2 $\frac{1}{8}$ in 14 x 50 mm	2
59-0090	ACF Micro Blade, Short Teeth	Blue	$\frac{9}{16}$ x 1 $\frac{3}{8}$ in 14 x 35 mm	2
59-0091	ACF Micro Blade, Short Teeth	Red	$\frac{9}{16}$ x 1 $\frac{5}{8}$ in 14 x 40 mm	2
59-0092	ACF Micro Blade, Short Teeth	Green	$\frac{9}{16}$ x 1 $\frac{3}{4}$ in 14 x 45 mm	2
59-0093	ACF Micro Blade, Short Teeth	Violet	$\frac{9}{16}$ x 2 $\frac{1}{8}$ in 14 x 50 mm	2
59-0094	ACF Micro Blade, Short Teeth	Black	$\frac{9}{16}$ x 2 $\frac{1}{8}$ in 14 x 55 mm	2
59-0095	ACF Micro Blade, Short Teeth	Gold	$\frac{9}{16}$ x 2 $\frac{3}{8}$ in 14 x 60 mm	2
59-0106	ACF Color Coded Depth Gauge			1
59-0105	Blade Loading Locking Retractor Handle			2

## Kits (Cervical Retractor)



### Ultra ReVeal ACF Removal Body Tray

Tray Two of Three

59-0000

CODE	DESCRIPTION	COLOR	LENGTH	QUANTITY
59-0000	Complete ACF Retractor System			1
59-0050	ACF Blade, Short Teeth	Silver	1 1/8 in 30 mm	1
59-0051	ACF Blade, Short Teeth	Blue	1 3/8 in 35 mm	1
59-0052	ACF Blade, Short Teeth	Red	1 5/8 in 40 mm	1
59-0053	ACF Blade, Short Teeth	Green	1 3/4 in 45 mm	1
59-0054	ACF Blade, Short Teeth	Violet	2 in 50 mm	1
59-0055	ACF Blade, Short Teeth	Black	2 1/8 in 55 mm	1
59-0056	ACF Blade, Short Teeth	Gold	2 3/8 in 60 mm	1
59-0057	ACF Blade, Short Teeth	Navy	2 1/2 in 65 mm	1
59-0070	ACF Blade, Long Teeth	Silver	1 1/8 in 30 mm	1
59-0071	ACF Blade, Long Teeth	Blue	1 3/8 in 35 mm	1
59-0072	ACF Blade, Long Teeth	Red	1 5/8 in 40 mm	1
59-0073	ACF Blade, Long Teeth	Green	1 3/4 in 45 mm	1
59-0074	ACF Blade, Long Teeth	Violet	2 in 50 mm	1
59-0075	ACF Blade, Long Teeth	Black	2 1/8 in 55 mm	1
59-0076	ACF Blade, Long Teeth	Gold	2 3/8 in 60 mm	1
59-0077	ACF Blade, Long Teeth	Navy	2 1/2 in 65 mm	1
59-0101	Side-Loading Longitudinal Retractor, with Double Hinge			1
59-0100	Side-Loading Transverse Retractor, with Double Hinge		4 3/4 in 120 mm	1
59-0113	Screw Driver			2
59-0109	Twist Drill			2

## Kits (Cervical Retractor)



### Ultra ReVeal ACF Cervical Retractor Tray

Tray Three of Three

CODE	DESCRIPTION	QUANTITY
59-0000	Complete ACF Retractor System	1
59-0131	Bone Graft Holder	1
59-0117	Distractor Single Level, Left with 3 <sup>15</sup> / <sub>16</sub> in (100 mm) Rack	1
59-0118	Distractor Single Level, Right with 3 <sup>15</sup> / <sub>16</sub> in (100 mm) Rack	1
59-0116	Distractor Multiple Level, Left with 4 <sup>3</sup> / <sub>4</sub> in (120 mm) Rack	1
59-0115	Distractor Multiple Level, Right with 4 <sup>3</sup> / <sub>4</sub> in (120 mm) Rack	1
59-0111	Drill Guide, Left for 59-0116/59-0117	1
59-0110	Drill Guide, Right for 59-0118/59-0115	1
59-0120	ACF Caliper	1
59-0124	ACF Bone Graft Harvesting Forcep, <sup>3</sup> / <sub>11</sub> in (7 mm)	1
59-0121	ACF Bone Tamp, <sup>1</sup> / <sub>8</sub> in (3 mm)	1
59-0122	ACF Bone Tamp, <sup>1</sup> / <sub>5</sub> in (5 mm)	1
59-0123	ACF Bone Tamp, <sup>5</sup> / <sub>16</sub> in (8 mm)	1

## Kits (Cervical Retractor)



### Ultra ReVeal LoPro Retractor Tray

CODE	DESCRIPTION	LENGTH		QUANTITY
59-3000	Complete LoPro Retractor System			
59-2001	Cervical Retractor Frame, Right			1
59-2002	Cervical Retractor Frame, Left			1
59-2003	Cervical Retractor Frame, Offset			1
59-2006	Cervical Retractor Blade, Pronged	$\frac{7}{8} \times 1$ in	22 x 25 mm	2
59-2007	Cervical Retractor Blade, Pronged	$\frac{7}{8} \times 1\frac{1}{8}$ in	22 x 30 mm	2
59-2008	Cervical Retractor Blade, Pronged	$\frac{7}{8} \times 1\frac{3}{8}$ in	22 x 35 mm	2
59-2009	Cervical Retractor Blade, Pronged	$\frac{7}{8} \times 1\frac{5}{8}$ in	22 x 40 mm	2
59-2010	Cervical Retractor Blade, Pronged	$\frac{7}{8} \times 1\frac{3}{4}$ in	22 x 45 mm	2
59-2011	Cervical Retractor Blade, Pronged	$\frac{7}{8} \times 2\frac{1}{8}$ in	22 x 50 mm	2
59-2012	Cervical Retractor Blade, Pronged	$\frac{7}{8} \times 2\frac{1}{8}$ in	22 x 55 mm	2
59-2013	Cervical Retractor Blade, Pronged	$\frac{7}{8} \times 2\frac{3}{8}$ in	22 x 60 mm	2
59-2014	Cervical Retractor Blade, Pronged	$\frac{7}{8} \times 2\frac{1}{2}$ in	22 x 65 mm	2
59-2015	Cervical Retractor Blade, Pronged	$\frac{7}{8} \times 2\frac{3}{4}$ in	22 x 70 mm	2
59-2016	Cervical Retractor Blade, Pronged	$\frac{7}{8} \times 3$ in	22 x 75 mm	2
59-2017	Cervical Retractor Blade, Blunt	$\frac{7}{8} \times 1$ in	22 x 25 mm	2
59-2018	Cervical Retractor Blade, Blunt	$\frac{7}{8} \times 1\frac{1}{8}$ in	22 x 30 mm	2
59-2019	Cervical Retractor Blade, Blunt	$\frac{7}{8} \times 1\frac{3}{8}$ in	22 x 35 mm	2
59-2020	Cervical Retractor Blade, Blunt	$\frac{7}{8} \times 1\frac{5}{8}$ in	22 x 40 mm	2
59-2021	Cervical Retractor Blade, Blunt	$\frac{7}{8} \times 1\frac{3}{4}$ in	22 x 45 mm	2
59-2023	Cervical Retractor Blade, Blunt	$\frac{7}{8} \times 2\frac{1}{8}$ in	22 x 50 mm	2
59-2024	Cervical Retractor Blade, Blunt	$\frac{7}{8} \times 2\frac{1}{8}$ in	22 x 55 mm	2
59-2025	Cervical Retractor Blade, Blunt	$\frac{7}{8} \times 2\frac{3}{8}$ in	22 x 60 mm	2
59-2026	Cervical Retractor Blade, Bi-Leveled Pronged	$1\frac{1}{16} \times 1\frac{1}{8}$ in	27 x 30 mm	4
59-2027	Cervical Retractor Blade, Bi-Leveled Blunt	$1\frac{1}{16} \times 1\frac{1}{8}$ in	27 x 30 mm	2
59-2028	Cervical Retractor Blade, Bi-Leveled Pronged	$1\frac{1}{16} \times 1\frac{5}{8}$ in	27 x 40 mm	4
59-2029	Cervical Retractor Blade, Bi-Leveled Blunt	$1\frac{1}{16} \times 1\frac{5}{8}$ in	27 x 40 mm	2
59-2035	Cervical Retractor Blade, Bi-Leveled Pronged	$1\frac{1}{16} \times 1\frac{3}{4}$ in	27 x 45 mm	4
59-2036	Cervical Retractor Blade, Bi-Leveled Blunt	$1\frac{1}{16} \times 1\frac{3}{4}$ in	27 x 45 mm	2
59-2037	Micro Discectomy Adaptor for ACF Retractor Set			1
59-2038	Spike Blade	$2\frac{3}{4}$ in	70 mm	1
59-2039	T-Shaped Blade	$2\frac{3}{4}$ in	70 mm	1
59-2004	Inner Spinal Ligament			1
59-2005	Blade Holding Retractor			2
59-2040	Case			1

## Kits (Cervical Retractor)

Image Not Available



### Ultra ReVeal Lumbar Instrument System

Tray One of Three

CODE	DESCRIPTION	LENGTH		QUANTITY
59-1000S	Ultra ReVeal Lumbar Instrument Tray			1
59-1104	Scoville Lumbar Retractor, Double Hinged	7 $\frac{7}{8}$ in	200 mm	1
59-1100	Lumbar Retractor Body for Multiple Blades			1
59-1103	Side-Loading Lumbar Retractor Blade Holder			4
59-1102	Lumbar Retractor Adjustable Blade Holder			4
59-1001	Lumbar Retractor T-Handle			1
59-1105	Side-Loading Locking Retractor Handle			2
59-1080	Hook, Sharp Toothed Shaft	1 $\frac{5}{8}$ in	40 mm	1
59-1081	Hook, Sharp Toothed Shaft	2 in	50 mm	1
59-1082	Hook, Sharp Toothed Shaft	2 $\frac{3}{8}$ in	60 mm	1
59-1083	Hook, Sharp Toothed Shaft	2 $\frac{3}{4}$ in	70 mm	1
59-1084	Lumbar Spinal T-Bar	1 x 1 $\frac{5}{8}$ in	25 x 40 mm	1
59-1085	Lumbar Spinal T-Bar	1 x 2 in	25 x 50 mm	1
59-1086	Lumbar Spinal T-Bar	1 x 2 $\frac{3}{8}$ in	25 x 60 mm	1
59-1087	Lumbar Spinal T-Bar	1 x 2 $\frac{3}{4}$ in	25 x 70 mm	1

Image Not Available



### Ultra ReVeal Multi-Level Retractor System

Tray Two of Three

CODE	DESCRIPTION	LENGTH		QUANTITY
59-1030	Blade Angled Out 15°, with Teeth, Titanium	$10\frac{1}{11}$ x 1 $\frac{3}{8}$ in	23 x 35 mm	4
59-1031	Blade Angled Out 15°, with Teeth, Titanium	$10\frac{1}{11}$ x 1 $\frac{3}{4}$ in	23 x 45 mm	4
59-1032	Blade Angled Out 15°, with Teeth, Titanium	$10\frac{1}{11}$ x 2 $\frac{1}{8}$ in	23 x 55 mm	4
59-1033	Blade Angled Out 15°, with Teeth, Titanium	$10\frac{1}{11}$ x 2 $\frac{1}{2}$ in	23 x 65 mm	4
59-1034	Blade Angled Out 15°, with Teeth, Titanium	$10\frac{1}{11}$ x 3 in	23 x 75 mm	4
59-1035	Blade Angled Out 15°, with Teeth, Titanium	$10\frac{1}{11}$ x 3 $\frac{3}{8}$ in	23 x 85 mm	4
59-1036	Blade Angled Out 15°, with Teeth, Titanium	$10\frac{1}{11}$ x 3 $\frac{15}{16}$ in	23 x 100 mm	4
59-1037	Blade Angled Out 15°, with Teeth, Titanium	$10\frac{1}{11}$ x 4 $\frac{3}{4}$ in	23 x 120 mm	4

## Kits (Cervical Retractor)

Image Not Available



### Ultra ReVeal Lumbar Instrument System

Tray Three of Three

CODE	DESCRIPTION	LENGTH		QUANTITY
59-1050	Blade Angled Out 15°, with Teeth, Titanium	1 3/4 x 2 in	45 x 50 mm	2
59-1051	Blade Angled Out 15°, with Teeth, Titanium	1 3/4 x 2 3/8 in	45 x 60 mm	2
59-1052	Blade Angled Out 15°, with Teeth, Titanium	1 3/4 x 2 3/4 in	45 x 70 mm	2
59-1053	Blade Angled Out 15°, with Teeth, Titanium	1 3/4 x 3 1/8 in	45 x 80 mm	2
59-1056	Blade Angled Out 15°, with Teeth, Titanium	2 3/8 x 2 in	60 x 50 mm	2
59-1057	Blade Angled Out 15°, with Teeth, Titanium	2 3/8 x 2 3/8 in	60 x 60 mm	2
59-1058	Blade Angled Out 15°, with Teeth, Titanium	2 3/8 x 2 3/4 in	60 x 70 mm	2
59-1059	Blade Angled Out 15°, with Teeth, Titanium	2 3/8 x 3 1/7 in	60 x 80 mm	2
59-1060	Blade Angled Out 15°, with Teeth, Titanium	2 3/8 x 3 15/16 in	60 x 100 mm	2
59-1061	Blade Angled Out 15°, with Teeth, Titanium	2 3/8 x 4 3/4 in	60 x 120 mm	2
59-1070	Blade Sacral Cutout with Teeth, Titanium, Right	1 1/4 x 1 5/8 in	30 x 40 mm	1
59-1071	Blade Sacral Cutout with Teeth, Titanium, Left	1 1/4 x 1 5/8 in	30 x 40 mm	1
59-1072	Blade Sacral Cutout with Teeth, Titanium, Right	2 3/8 x 1 3/4 in	60 x 45 mm	1
59-1073	Blade Sacral Cutout with Teeth, Titanium, Left	2 3/8 x 1 3/4 in	60 x 45 mm	1
59-1700	Case			1

## Kits (Cervical Retractor)

Image Not Available



### Anterior Cervical Fusion Kit with Case

CODE	DESCRIPTION
11-1011	Set Includes
80-1004	Anterior Fusion Kit Includes the Following Items:
21-1001	Instrument Case
11-1002	Cross Bar Handle (two each)
56-1005	12 mm Diameter Dowel Cutter
56-1006	14 mm Diameter Dowel Cutter
56-1007	16 mm Diameter Dowel Cutter
56-1008	18 mm Diameter Dowel Cutter
47-1010	12 mm Dowel Cutter Center Pin
47-1011	14 mm Dowel Cutter Center Pin
47-1012	16 mm Dowel Cutter Center Pin
47-1013	18 mm Dowel Cutter Center Pin
11-1019	Dowel Cutter Shaft
80-1001	Dowel Ejector
11-1011	Dowel Handle and Ejector
26-1265	10 mm Drill Tip
26-1266	12 mm Drill Tip
26-1267	14 mm Drill Tip
26-1268	16 mm Drill Tip
12-1005C	Small Cervical Drill Guard
12-1006C	Large Cervical Drill Guard
12-1007	Drill Guard Cap
28-1001	Small Drill Shaft
28-1002	Large Drill Shaft
65-1064	Osteophyte Periosteal Elevator
39-1012	Depth Gauge
14-1043	Small Guard Guide, Double-Ended
14-1044	Large Guard Guide, Double-Ended
61-1004	Vertebra Spreader
80-1012	Spanner Wrench



## Kits



80-1006

### PLIF II Instrument Kit

CODE	DESCRIPTION	LENGTH
80-1006	Kit	7 in 178 mm
21-1006	PLIF II Instrument Case	
23-1020C	Cone Ring Curette, Angled 5°, Ring (I.D.) $\frac{5}{16}$ in (8 mm)	9 in 229 mm
65-1056	Periosteal Elevator, No. 1, 4 mm, Sharp	
65-1057	Periosteal Elevator, No. 2, 6 mm, Sharp	
65-1058	Periosteal Elevator, No. 3, 8 mm, Sharp	
65-1121	Periosteal Elevator, Sharp, $\frac{3}{16}$ in	
46-1021	Osteotome, Straight, Blade Width 6 mm	7 $\frac{1}{2}$ in 191 mm
46-1025	Osteotome, Straight, Blade Width 6 mm	9 $\frac{1}{2}$ in 241 mm
46-1019	Osteotome, Straight, Blade Width 10 mm	9 $\frac{1}{2}$ in 241 mm
46-1020	Osteotome, Curved, Blade Width 6 mm	7 $\frac{1}{2}$ in 191 mm
46-1024	Osteotome, Full Curve, Blade Width 6 mm	9 $\frac{1}{2}$ in 241 mm
46-1023	Osteotome, Slightly Curved, Blade Width 8 mm	9 $\frac{1}{2}$ in 241 mm
50-1209	Flexible Nerve Root Retractor, Blade Width $\frac{5}{16}$ in (8 mm)	8 $\frac{1}{2}$ in 216 mm

## Kits



## Karlin XI Magnum Cup Curette

CODE	DESCRIPTION	LENGTH
46-3226	Forward Straight, 7 mm	13¼ in 337 mm
46-3227	Forward Straight, 9 mm	13¼ in 337 mm
46-3228	Forward Straight, 11 mm	13¼ in 337 mm
46-3229	Forward Straight, 13 mm	13¼ in 337 mm
46-3230	Forward Straight, 15 mm	13¼ in 337 mm
46-3236	Forward Straight, 17 mm	13¼ in 337 mm
46-3237	Forward Straight, 19 mm	13¼ in 337 mm
46-3225	Set (12), Extra Long Currettes, Black Handles, Lightweight	13¼ in 337 mm
46-3234	Down Pushing, 7 mm	13¼ in 337 mm
46-3235	Down Pushing, 9 mm	13¼ in 337 mm
46-3231	Forward Angle, 7 mm	13¼ in 337 mm
46-3232	Forward Angle, 9 mm	13¼ in 337 mm
46-3233	Forward Angle, 11 mm	13¼ in 337 mm

## Kits



### Lumbar Microdiscectomy Set

CODE	DESCRIPTION	LENGTH
46-3120	Lumbar Microdiscectomy Set, 24 Instruments, Set Includes Two Cases	9½ in 241 mm
46-3130	Lumbar Microdiscectomy Curette, Backwards Straight, 0	9½ in 241 mm
46-3131	Lumbar Microdiscectomy Curette, Backwards Straight, 1	9½ in 241 mm
46-3132	Lumbar Microdiscectomy Curette, Backwards Straight, 2	9½ in 241 mm
46-3133	Lumbar Microdiscectomy Curette, Backwards Angle, 0	9½ in 241 mm
46-3134	Lumbar Microdiscectomy Curette, Backwards Angle, 1	9½ in 241 mm
46-3135	Lumbar Microdiscectomy Curette, Backwards Angle, 2	9½ in 241 mm
46-3136	Lumbar Microdiscectomy Curette, Backwards Down, 0	9½ in 241 mm
46-3137	Lumbar Microdiscectomy Curette, Backwards Down, 1	9½ in 241 mm
46-3138	Lumbar Microdiscectomy Curette, Backwards Down, 2	9½ in 241 mm
46-3121	Lumbar Microdiscectomy Curette, Forward Straight, 0	9½ in 241 mm
46-3122	Lumbar Microdiscectomy Curette, Forward Straight, 1	9½ in 241 mm
46-3123	Lumbar Microdiscectomy Curette, Forward Straight, 2	9½ in 241 mm
46-3124	Lumbar Microdiscectomy Curette, Forward Angle, 0	9½ in 241 mm
46-3125	Lumbar Microdiscectomy Curette, Forward Angle, 1	9½ in 241 mm
46-3126	Lumbar Microdiscectomy Curette, Forward Angle, 2	9½ in 241 mm
46-3127	Lumbar Microdiscectomy Curette, Forward Down, 0	9½ in 241 mm
46-3128	Lumbar Microdiscectomy Curette, Forward Down, 1	9½ in 241 mm
46-3129	Lumbar Microdiscectomy Curette, Forward Down, 2	9½ in 241 mm
46-3139	Penfield Dissector, Lumbar #1	9½ in 241 mm
46-3140	Penfield Dissector, Lumbar #2	9½ in 241 mm
46-3142	Penfield Dissector, Lumbar #4	9½ in 241 mm
46-3141	Lumbar Nerve Hook	9½ in 241 mm
46-3143	Lumbar Bone Waxer	9½ in 241 mm
46-3144	Lumbar Probe	9½ in 241 mm
46-3145	Lumbar Microdiscectomy Case, Storage/Sterilizing Case for 12 Instruments	

Kits



Lumbar Spondylophyte Impaction Set

The impaction set is surgeon designed to correct symptomatic spondylophytes. Complementary instruments have been assembled in a set to meet expected indications. Additional (optional) support instruments are available for broader indications

CODE	DESCRIPTION
46-3002	The set includes one each of the following:
46-3003	Display Case
46-3005	Bayonet Dural Suction Retractor, Macro-Tip $\frac{7}{16}$ in (10 mm)
46-3006	Annular Dissector Perforator
46-3007	Offset Central Canal Impactor
46-3009	Lateral Gutter Impactor
46-3012	Black 90° Dural Suction Retractor, Micro-Tip $\frac{5}{16}$ in (8 mm)

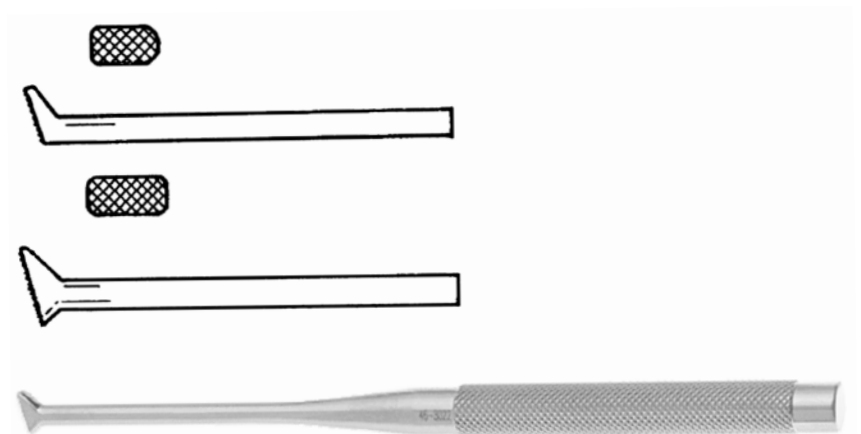

Micro Impactor Set

CODE	DESCRIPTION	LENGTH
46-3020	Micro Impactor Set	7 in 178 mm
46-3022	Micro Lateral Gutter Impactor, Tip Size $\frac{3}{8}$ in (9.4 mm)	7 in 178 mm
46-3021	Micro Offset Central Canal Impactor, Tip Size $\frac{1}{8}$ in (4.3 mm)	7 in 178 mm

## Kits



### Magnum Ring Curette Kit

CODE	DESCRIPTION	TIP SIZE	WORKING DISTANCE	HANDLE LENGTH	TOTAL LENGTH
46-3400	Magnum Ring Curettes, Kit with Case				
46-3401	Straight	6 mm	4 $\frac{7}{10}$ in 120 mm	7 $\frac{4}{5}$ in 200 mm	12 $\frac{3}{5}$ in 320 mm
46-3402	Straight	8 mm	4 $\frac{7}{10}$ in 120 mm	7 $\frac{4}{5}$ in 200 mm	12 $\frac{3}{5}$ in 320 mm
46-3403	Straight	10 mm	4 $\frac{7}{10}$ in 120 mm	7 $\frac{4}{5}$ in 200 mm	12 $\frac{3}{5}$ in 320 mm
46-3404	Angle	6 mm	4 $\frac{7}{10}$ in 120 mm	7 $\frac{4}{5}$ in 200 mm	12 $\frac{3}{5}$ in 320 mm
46-3405	Angle	8 mm	4 $\frac{7}{10}$ in 120 mm	7 $\frac{4}{5}$ in 200 mm	12 $\frac{3}{5}$ in 320 mm
46-3406	Angle	10 mm	4 $\frac{7}{10}$ in 120 mm	7 $\frac{4}{5}$ in 200 mm	12 $\frac{3}{5}$ in 320 mm

## Kits



## Karlin Curved Stiletto Osteotome Set with Case

CODE	DESCRIPTION	TIP SIZE	LENGTH
46-3050	Set with Case		8½ in 216 mm
46-3051	Curved	¼ in 6 mm	8½ in 216 mm
46-3052	Curved	⅜ in 10 mm	8½ in 216 mm
46-3053	Curved	½ in 13 mm	8½ in 216 mm
46-3054	Curved	⅝ in 16 mm	8½ in 216 mm
46-3055	Curved	¾ in 19 mm	8½ in 216 mm
46-3056	Case for Curved Stiletto Osteotome		8½ in 216 mm



## Case for Straight Stiletto Osteotome

CODE	DESCRIPTION	TIP SIZE	LENGTH
46-3060	Case for Straight Stiletto Osteotome		8½ in 216 mm
46-3061	Straight	¼ in 6 mm	8½ in 216 mm
46-3062	Straight	⅜ in 10 mm	8½ in 216 mm
46-3063	Straight	½ in 13 mm	8½ in 216 mm
46-3064	Straight	⅝ in 16 mm	8½ in 216 mm
46-3065	Straight	¾ in 19 mm	8½ in 216 mm
46-3066	Stiletto Straight Osteotome Case		8½ in 216 mm

## Kits (Transoral)



### Crockard Transoral Instrument Set

The Crockard Transoral Instrument Set is a coordinated set of instruments used to approach a large area of pathology from the sphenoid to the C3 vertebra via the transoral technique.

CODE	DESCRIPTION	QUANTITY
50-1670	Set Includes:	
50-1651	Crockard Transoral Retractor Body	1/Each
50-1652	Crockard Large Tongue Retractor Blade	1/Each
50-1653	Crockard Small Tongue Retractor Blade	1/Each
50-1654	Crockard 90° Retractor Blade	2/Each
50-1655	Crockard Curved Retractor Blade	2/Each
50-1656	Crockard Retractor Blade Connector	2/Each
50-1657	Crockard Suction Tube Holder, Short	1/Each
50-1658	Crockard Suction Tube Holder, Long	1/Each
50-1659	Crockard Hard Palate Retractor	1/Each
50-1660	Crockard Pharyngeal Retractor, Small	1/Each
50-1661	Crockard Pharyngeal Retractor, Large	1/Each
50-1662	Crockard Odontoid Peg Grasping Forceps	1/Each
50-1663	Crockard Ligament Grasping Forceps	1/Each
50-1664	Crockard Sterilizing/Storage Case	

## Kits (Vertebral Body Biopsy)



### Craig Vertebral Body Biopsy Kit

CODE	DESCRIPTION	LENGTH
24-2500	Stainless Steel Rack, Includes:	
	Needle, 20 G - For infiltration of operative area	
	Needle, 22 G - For similar use	
	Calibrated Blunt Trocars, Two - For blunt dissection through soft tissues to vertebral body	
	Calibrated Cannula - If X-ray demonstrate trocar is in satisfactory position, cannula is then inserted over it	
	Tooth Cutter - Use within the calibrated cannula to obtain a 3 mm core	
	Sharp Cutter - Use within the calibrated cannula to obtain a 3 mm core	
	Socket Wrench - Used with either cutter	
	Stylet - Used to expel biopsy section	
	Sharp Worm Hook - To withdraw soft tissue cuttings	



## Kits

Image Not Available



### Karlin XL Cervical Curette Set

CODE	DESCRIPTION	WORKING DISTANCE	TOTAL LENGTH
46-2625	Curette Set, XL Cervical Microdiscectomy, Set/24		
46-2639	Karlin XL Cervical Curette	Backward Straight, 0000	4 1/10 in 104 mm 9 1/2 in 240 mm
46-2638	Karlin XL Cervical Curette	Backward Straight, 000	4 1/10 in 104 mm 9 1/2 in 240 mm
46-2637	Karlin XL Cervical Curette	Backward Straight, 00	4 1/10 in 104 mm 9 1/2 in 240 mm
46-2636	Karlin XL Cervical Curette	Backward Straight, 0	4 1/10 in 104 mm 9 1/2 in 240 mm
46-2644	Karlin XL Cervical Curette	Backward Angle, 0000	4 1/10 in 104 mm 9 1/2 in 240 mm
46-2643	Karlin XL Cervical Curette	Backward Angle, 000	4 1/10 in 104 mm 9 1/2 in 240 mm
46-2642	Karlin XL Cervical Curette	Backward Angle, 00	4 1/10 in 104 mm 9 1/2 in 240 mm
46-2645	Karlin XL Cervical Curette	Backward Angle	4 1/10 in 104 mm 9 1/2 in 240 mm
46-2629	Karlin XL Cervical Curette	Forward Straight, 0000	4 1/10 in 104 mm 9 1/2 in 240 mm
46-2628	Karlin XL Cervical Curette	Forward Straight, 000	4 1/10 in 104 mm 9 1/2 in 240 mm
46-2627	Karlin XL Cervical Curette	Forward Straight, 00	4 1/10 in 104 mm 9 1/2 in 240 mm
46-2626	Karlin XL Cervical Curette	Forward Straight, 0	4 1/10 in 104 mm 9 1/2 in 240 mm
46-2634	Karlin XL Cervical Curette	Forward Angle, 0000	4 1/10 in 104 mm 9 1/2 in 240 mm
46-2633	Karlin XL Cervical Curette	Forward Angle, 000	4 1/10 in 104 mm 9 1/2 in 240 mm
46-2632	Karlin XL Cervical Curette	Forward Angle, 00	4 1/10 in 104 mm 9 1/2 in 240 mm
46-2631	Karlin XL Cervical Curette	Forward Angle, 0	4 1/10 in 104 mm 9 1/2 in 240 mm
46-2640	Karlin XL Bone Cutter	Backward Straight	4 1/10 in 104 mm 9 1/2 in 240 mm
46-2630	Karlin XL Bone Cutter	Forward Straight	4 1/10 in 104 mm 9 1/2 in 240 mm
46-2635	Karlin XL Bone Cutter	Forward Angle	4 1/10 in 104 mm 9 1/2 in 240 mm
46-2646	XL Cervical Micro Nerve Hook		4 1/10 in 104 mm 9 1/2 in 240 mm
46-2647	XL Cervical Ultra Micro Nerve Hook		4 1/10 in 104 mm 9 1/2 in 240 mm
46-2648	Cervical Bone Waxer	XL Cervical	4 1/10 in 104 mm 9 1/2 in 240 mm
46-3174	Karlin XL Micro Knife Handle		4 1/10 in 104 mm 9 1/2 in 240 mm
46-3145	Storage/Sterilizing Case, For 12 Instruments 2 Provided with Kit		4 1/10 in 104 mm 9 1/2 in 240 mm

## Kits



## Karlin XL Magnum Cobb Elevator Set

CODE	DESCRIPTION	LENGTH
46-3240	Set of Six In Case for 12 Instruments - Includes:	
46-3241	10 mm	13¼ in 337 mm
46-3242	15 mm	13¼ in 337 mm
46-3243	20 mm	13¼ in 337 mm
46-3244	25 mm	13¼ in 337 mm
46-3245	30 mm	13¼ in 337 mm
46-3246	35 mm	13¼ in 337 mm

## Kits



### Microsect Curette Kit

CODE	DESCRIPTION		LENGTH	
47-5010	Microsect Curette Kit, Includes 12 Currettes and Tray			
47-5012	Backward Angle	#1 Curette	10 in	254 mm
47-5014	Backward Angle	#2 Curette	10 in	254 mm
47-5016	Backward Angle	#3 Curette	10 in	254 mm
47-5018	Backward Angle	#4 Curette	10 in	254 mm
47-5020	Backward Angle	#5 Curette	10 in	254 mm
47-5011	Forward Angle	#1 Curette	10 in	254 mm
47-5013	Forward Angle	#2 Curette	10 in	254 mm
47-5015	Forward Angle	#3 Curette	10 in	254 mm
47-5017	Forward Angle	#4 Curette	10 in	254 mm
47-5019	Forward Angle	#5 Curette	10 in	254 mm
47-5021	Straight Dissector	3 mm	10 in	254 mm
47-5022	Straight Dissector	5 mm	10 in	254 mm
47-5023	Microsect Curette Tray			

## Knife Handles

### Javelin Micro-Knife Handle

CODE	TIP	WORKING DISTANCE		LENGTH	
46-3177	Micro 2 mm	4 <sup>3</sup> / <sub>5</sub> in	117 mm	8 <sup>1</sup> / <sub>2</sub> in	216 mm
46-3178	Ultra 1.5 mm	4 <sup>3</sup> / <sub>5</sub> in	117 mm	8 <sup>1</sup> / <sub>2</sub> in	216 mm



### Karlin XL Micro Knife Handle

CODE	HANDLE LENGTH
46-3174	4 <sup>1</sup> / <sub>10</sub> in 104 mm



## Knives

### Hardy Knife Handle

CODE	DESCRIPTION	WORKING DISTANCE		LENGTH	
80-1313	Bayonet, Vertical	3 <sup>1</sup> / <sub>2</sub> in	90 mm	8 <sup>1</sup> / <sub>16</sub> in	205 mm

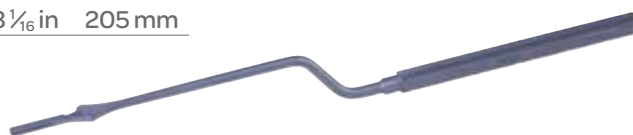

## Mallets (Cervical)

### Cervical Hammer

CODE	DESCRIPTION	DIAMETER		LENGTH	
88-1005	Small Face, 8 oz	<sup>3</sup> / <sub>4</sub> in	19 mm	7 <sup>1</sup> / <sub>2</sub> in	191 mm
88-1006	Large Face, 13 oz	1 in	25 mm	9 in	229 mm



## Mallets

### Heath Mallet

CODE	HEAD DIMENSIONS		DESCRIPTION	LENGTH	
32-3330	2½x1½in	64x40mm	2lbs 908g	7¼in	184mm

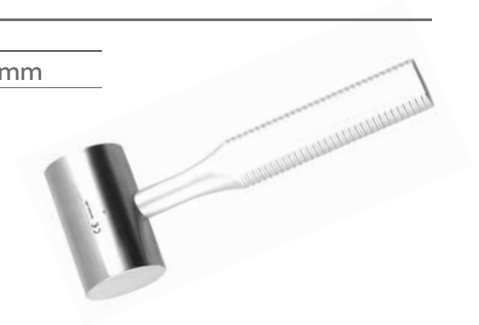

### Hibbs Mallet

CODE	DESCRIPTION	DESCRIPTION	LENGTH	
88-2520	Solid Brass Head	12oz 340g	1½x8in	38x203mm



### Karlin Mallet

CODE	DESCRIPTION	WEIGHT	DIAMETER	LENGTH
46-3179	Small	7.1oz 200g	1in 25mm	9½in 241mm
46-3146	Large	12oz 340g	1¼in 32mm	9¾in 248mm



### Smith-Peterson Mallet, Small

CODE	DESCRIPTION	WEIGHT	LENGTH	
88-2500	Solid Brass Head	15oz 420g	1½x7in	38x178mm



## Osteotomes (Spinal)

### Spinal Fusion Osteotome

CODE	DESCRIPTION	BLADE WIDTH	LENGTH	
28-1022	Straight	8 mm	9 ½ in	241 mm
46-1022	Straight	8 mm	9 ½ in	241 mm
28-1026	Curved	6 mm	9 ½ in	241 mm
46-1026	Curved	6 mm	9 ½ in	241 mm
28-1023	Curved	8 mm	9 ½ in	241 mm



28-1023

## Osteotomes

### Cherry Osteotome

CODE	DESCRIPTION	BLADE WIDTH	LENGTH	
57-3803	Straight	3 mm	8 in	203 mm
57-3807	Straight	7 mm	8 in	203 mm
57-3813	Curved	3 mm	8 in	203 mm
57-3814	Curved	4 mm	8 in	203 mm
57-3815	Curved	5 mm	8 in	203 mm
57-3816	Curved	6 mm	8 in	203 mm
57-3817	Curved	7 mm	8 in	203 mm



57-3813

### Cobb Osteotome

CODE	DESCRIPTION	BLADE WIDTH	LENGTH	
28-7020	Straight	¼ in	11 in	279 mm
28-7021	Straight	⅜ in	11 in	279 mm
28-7022	Straight	½ in	11 in	279 mm
28-7023	Straight	⅝ in	11 in	279 mm
28-7024	Straight	¾ in	11 in	279 mm
28-7025	Straight	1 in	11 in	279 mm

Image Not Available



### Cobb Osteotome

CODE	DESCRIPTION	BLADE WIDTH	LENGTH	
28-7027	Curved	¼ in	11 in	279 mm
28-7028	Curved	⅜ in	11 in	279 mm
28-7029	Curved	½ in	11 in	279 mm
28-7030	Curved	⅝ in	11 in	279 mm
28-7031	Curved	¾ in	11 in	279 mm
28-7032	Curved	1 in	11 in	279 mm
28-7033	Curved	1 ¼ in	11 in	279 mm



28-7027

## Osteotomes

### Hibbs Osteotome

CODE	DESCRIPTION	BLADE WIDTH		LENGTH	
28-5106	Straight	¼ in	6 mm	9½ in	241 mm
28-5110	Straight	⅜ in	10 mm	9½ in	241 mm
28-5112	Straight	½ in	13 mm	9½ in	241 mm
28-5116	Straight	⅝ in	16 mm	9½ in	241 mm
28-5120	Straight	¾ in	19 mm	9½ in	241 mm
28-5122	Straight	⅞ in	22 mm	9½ in	241 mm
28-5125	Straight	1 in	25 mm	9½ in	241 mm
28-5130	Straight	1⅛ in	29 mm	9½ in	241 mm
28-5132	Straight	1¼ in	32 mm	9½ in	241 mm
28-5140	Straight	1½ in	38 mm	9½ in	241 mm

Image Not Available



### Hibbs Osteotome

CODE	DESCRIPTION	BLADE WIDTH		LENGTH	
28-5156	Curved	¼ in	6 mm	9½ in	241 mm
28-5160	Curved	⅜ in	10 mm	9½ in	241 mm
28-5162	Curved	½ in	13 mm	9½ in	241 mm
28-5166	Curved	⅝ in	16 mm	9½ in	241 mm
28-5170	Curved	¾ in	19 mm	9½ in	241 mm
28-5172	Curved	⅞ in	22 mm	9½ in	241 mm
28-5175	Curved	1 in	25 mm	9½ in	241 mm
28-5180	Curved	1⅛ in	29 mm	9½ in	241 mm
28-5182	Curved	1¼ in	32 mm	9½ in	241 mm
28-5190	Curved	1½ in	38 mm	9½ in	241 mm



28-5156

### Hoke Osteotome

CODE	DESCRIPTION	BLADE WIDTH		LENGTH	
32-3439	Straight	⅛ in	3 mm	6 in	152 mm
32-3435	Straight	¼ in	6 mm	6 in	152 mm
32-3436	Straight	⅜ in	10 mm	6 in	152 mm
32-3437	Straight	½ in	13 mm	6 in	152 mm
32-3438	Straight	⅝ in	16 mm	6 in	152 mm



32-3438

## Osteotomes

### Hoke Osteotome

CODE	DESCRIPTION	BLADE WIDTH	LENGTH		
32-3430	Curved	$\frac{1}{8}$ in 3 mm	6 in	152 mm	
32-3431	Curved	$\frac{1}{4}$ in 6 mm	6 in	152 mm	
32-3432	Curved	$\frac{1}{2}$ in 13 mm	6 in	152 mm	
32-3433	Curved	$\frac{3}{8}$ in 10 mm	6 in	152 mm	
32-3434	Curved	$\frac{5}{8}$ in 16 mm	6 in	152 mm	

Image Not Available



### Hoke Osteotome

CODE	DESCRIPTION	BLADE WIDTH	LENGTH		
28-4903	Straight	$\frac{1}{8}$ in 3 mm	5 $\frac{1}{2}$ in	140 mm	
28-4904	Straight	$\frac{3}{16}$ in 5 mm	5 $\frac{1}{2}$ in	140 mm	
28-4906	Straight	$\frac{1}{4}$ in 6 mm	5 $\frac{1}{2}$ in	140 mm	
28-4908	Straight	$\frac{5}{15}$ in 8 mm	5 $\frac{1}{2}$ in	140 mm	
28-4910	Straight	$\frac{3}{8}$ in 10 mm	5 $\frac{1}{2}$ in	140 mm	
28-4912	Straight	$\frac{1}{2}$ in 13 mm	5 $\frac{1}{2}$ in	140 mm	

Image Not Available



### Hoke Osteotome

CODE	DESCRIPTION	BLADE WIDTH	LENGTH		
28-4953	Curved	$\frac{1}{8}$ in 3 mm	5 $\frac{1}{2}$ in	140 mm	
28-4954	Curved	$\frac{3}{16}$ in 5 mm	5 $\frac{1}{2}$ in	140 mm	
28-4956	Curved	$\frac{1}{4}$ in 6 mm	5 $\frac{1}{2}$ in	140 mm	
28-4958	Curved	$\frac{5}{15}$ in 8 mm	5 $\frac{1}{2}$ in	140 mm	
28-4960	Curved	$\frac{3}{8}$ in 10 mm	5 $\frac{1}{2}$ in	140 mm	
28-4962	Curved	$\frac{1}{2}$ in 13 mm	5 $\frac{1}{2}$ in	140 mm	

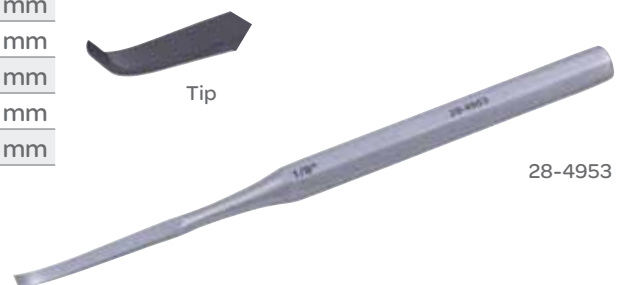



## Osteotomes

### Lambotte Osteotome

CODE	DESCRIPTION	LENGTH
27-5524	Curved with Calibration 4 mm	7¼ in 184 mm
27-5526	Curved with Calibration 6 mm	7¼ in 184 mm



27-5524

### Lambotte Osteotome

CODE	DESCRIPTION	LENGTH
27-5502	Straight with Calibration 2 mm	7¼ in 184 mm
27-5504	Straight with Calibration 4 mm	7¼ in 184 mm
27-5505	Straight with Calibration 5 mm	7¼ in 184 mm
27-5506	Straight with Calibration 6 mm	7¼ in 184 mm
27-5508	Straight with Calibration 8 mm	7¼ in 184 mm
27-5510	Straight with Calibration 10 mm	7¼ in 184 mm
27-5512	Straight with Calibration 12 mm	7¼ in 184 mm
27-5516	Straight with Calibration 16 mm	7¼ in 184 mm
27-5519	Straight with Calibration 19 mm	7¼ in 184 mm
27-5522	Straight with Calibration 22 mm	7¼ in 184 mm

Image Not Available



## Osteotomes

### Lambotte Osteotome

Without Calibration

CODE	DESCRIPTION	BLADE WIDTH	LENGTH
28-9406	Straight	¼ in 6 mm	9 in 229 mm
28-9412	Straight	½ in 13 mm	9 in 229 mm
28-9420	Straight	¾ in 20 mm	9 in 229 mm
28-9430	Straight	1¼ in 32 mm	9 in 229 mm
28-9440	Straight	1½ in 38 mm	9 in 229 mm

Image Not Available



### Lambotte Osteotome

CODE	DESCRIPTION	BLADE WIDTH	LENGTH
27-5812	Straight	½ in 13 mm	14 in 356 mm

Image Not Available



### McCulloch Osteotome

CODE	DESCRIPTION	BLADE WIDTH	LENGTH
57-5764		4 mm	8½ in
57-5765		6 mm	8½ in

Image Not Available



## Osteotomes

### Mini-Lambotte Osteotome

Swiss Pattern

CODE	DESCRIPTION	BLADE WIDTH	LENGTH
27-5702	Straight	2 mm	5 1/8 in 130 mm
27-5704	Straight	4 mm	5 1/8 in 130 mm
27-5706	Straight	6 mm	5 1/8 in 130 mm
27-5708	Straight	8 mm	5 1/8 in 130 mm
27-5710	Straight	10 mm	5 1/8 in 130 mm
27-5712	Straight	12 mm	5 1/8 in 130 mm
27-5714	Straight	14 mm	5 1/8 in 130 mm
27-5715	Straight	15 mm	5 1/8 in 130 mm
27-5718	Straight	18 mm	5 1/8 in 130 mm
27-5719	Straight	19 mm	5 1/8 in 130 mm
27-5720	Straight	20 mm	5 1/8 in 130 mm



27-5702

### Spinal Fusion Osteotome

CODE	DESCRIPTION	BLADE WIDTH	LENGTH
46-1021	Straight	1/4 in 6 mm	7 1/2 in 191 mm
46-1019	Straight	3/8 in 10 mm	9 1/2 in 241 mm
46-1020	Curved	1/4 in 6 mm	7 1/2 in 191 mm



46-1021

### Spinal Fusion Osteotome

CODE	DESCRIPTION	BLADE WIDTH	LENGTH
46-1025	Straight	1/4 in 6 mm	9 1/2 in 241 mm
46-1023	Slightly Curved	1/4 in 6 mm	9 1/2 in 241 mm
46-1024	Full Curve	5/16 in 8 mm	9 1/2 in 241 mm

Image Not Available



## Osteotomes

### Osteotome

CODE	DESCRIPTION	BLADE WIDTH		LENGTH	
46-2000	Straight	¼ in	6 mm	11 in	279 mm
46-2001	Straight	⅜ in	10 mm	11 in	279 mm
46-2002	Straight	½ in	13 mm	11 in	279 mm
46-2003	Straight	⅝ in	16 mm	11 in	279 mm
46-2004	Straight	¾ in	19 mm	11 in	279 mm
46-2005	Straight	1 in	25 mm	11 in	279 mm
46-2010	Curved	¼ in	6 mm	11 in	279 mm
46-2011	Curved	⅜ in	10 mm	11 in	279 mm
46-2012	Curved	½ in	13 mm	11 in	279 mm
46-2013	Curved	⅝ in	16 mm	11 in	279 mm
46-2014	Curved	¾ in	19 mm	11 in	279 mm
46-2015	Curved	1 in	25 mm	11 in	279 mm
46-2016	Curved	1¼ in	32 mm	11 in	279 mm

Image Not Available



### Osteotome

CODE	DESCRIPTION	TIP SIZE		LENGTH	
46-3051	Curved	¼ in	6 mm	8½ in	216 mm
46-3052	Curved	⅜ in	10 mm	8½ in	216 mm
46-3053	Curved	½ in	13 mm	8½ in	216 mm
46-3054	Curved	⅝ in	16 mm	8½ in	216 mm
46-3055	Curved	¾ in	19 mm	8½ in	216 mm

Image Not Available



### Sheehan Osteotome

CODE	WIDTH	LENGTH	
27-6202	2 mm	6¼ in	159 mm
27-6204	4 mm	6¼ in	159 mm
27-6206	6 mm	6¼ in	159 mm
27-6208	8 mm	6¼ in	159 mm
27-6210	10 mm	6¼ in	159 mm
27-6215	15 mm	6¼ in	159 mm
27-6218	18 mm	6¼ in	159 mm

Image Not Available



## Osteotomes

### Smith-Peterson Osteotome

CODE	DESCRIPTION	TIP SIZE	LENGTH
28-7106	Straight	¼ in 6 mm	8 in 203 mm
28-7112	Straight	½ in 13 mm	8 in 203 mm
28-7115	Straight	⅝ in 16 mm	8 in 203 mm
28-7120	Straight	¾ in 19 mm	8 in 203 mm
28-7125	Straight	1 in 25 mm	8 in 203 mm
28-7130	Straight	1¼ in 32 mm	8 in 203 mm
28-7230	Straight	1⅜ in 30 mm	8 in 203 mm

Image Not Available



### Smith-Peterson Osteotome

CODE	DESCRIPTION	TIP SIZE	LENGTH
28-7156	Curved	¼ in 6 mm	8 in 203 mm
28-7159	Curved	⅜ in 10 mm	8 in 203 mm
28-7162	Curved	½ in 13 mm	8 in 203 mm
28-7165	Curved	⅝ in 15 mm	8 in 203 mm
28-7175	Curved	1 in 25 mm	8 in 203 mm
28-7180	Curved	1¼ in 32 mm	8 in 203 mm
28-7280	Curved	1⅜ in 30 mm	8 in 203 mm



28-7165

### Smith-Peterson Osteotome

Blade Thickness 2 mm

CODE	DESCRIPTION	TIP SIZE	LENGTH
46-2500	Straight	¼ in 6 mm	8 in 203 mm
46-2501	Straight	⅜ in 10 mm	8 in 203 mm
46-2502	Straight	½ in 13 mm	8 in 203 mm
46-2503	Straight	⅝ in 15 mm	8 in 203 mm
46-2504	Straight	¾ in 19 mm	8 in 203 mm
46-2505	Straight	1 in 25 mm	8 in 203 mm
46-2506	Straight	1¼ in 32 mm	8 in 203 mm



46-2500

# Osteotomes

## Smith-Peterson Osteotome

Blade Thickness 2 mm

CODE	DESCRIPTION	TIP SIZE		LENGTH	
46-2510	Curved	¼ in	6 mm	8 in	203 mm
46-2511	Curved	⅜ in	10 mm	8 in	203 mm
46-2512	Curved	½ in	13 mm	8 in	203 mm
46-2513	Curved	⅝ in	16 mm	8 in	203 mm
46-2514	Curved	¾ in	19 mm	8 in	203 mm
46-2515	Curved	1 in	25 mm	8 in	203 mm
46-2516	Curved	1¼ in	32 mm	8 in	203 mm



## Karlin Stiletto Osteotome

CODE	DESCRIPTION	TIP SIZE		LENGTH	
46-3061	Straight	¼ in	6 mm	8 ½ in	216 mm
46-3062	Straight	⅜ in	10 mm	8 ½ in	216 mm
46-3063	Straight	½ in	13 mm	8 ½ in	216 mm
46-3064	Straight	⅝ in	16 mm	8 ½ in	216 mm
46-3065	Straight	¾ in	19 mm	8 ½ in	216 mm



46-3061

## Stille Osteotome

CODE	DESCRIPTION	TIP SIZE		LENGTH	
28-4404	Straight	4 mm		8 in	203 mm
28-4408	Straight	8 mm		8 in	203 mm
28-4410	Straight	10 mm		8 in	203 mm
28-4412	Straight	12 mm		8 in	203 mm
28-4414	Straight	14 mm		8 in	203 mm
28-4418	Straight	18 mm		8 in	203 mm
28-4422	Straight	22 mm		8 in	203 mm
28-4465	Curved	15 mm		8 in	203 mm
28-4470	Curved	20 mm		8 in	203 mm
28-4475	Curved	25 mm		8 in	203 mm



28-4404

## US Army Osteotome

CODE	DESCRIPTION	TIP SIZE		LENGTH	
28-2106		6 mm		6 ¼ in	159 mm
28-2112		12 mm		6 ¼ in	159 mm



28-2106

## Packers (Bone Chip)

### Bone Chip Packer

CODE	DESCRIPTION	LENGTH
27-9412	2.3 x 9.5 mm	10 in 254 mm
27-9411	3.1 x 15.8 mm	10 in 254 mm
27-9413	6.3 x 9.5 mm	10 in 254 mm
27-9415	6.3 mm Round	9½ in 241 mm



27-9411

## Packers

### Woodson Separator-Packer

Double-Ended with Grooved Blade

CODE	BLADE WIDTH	BLADE DEPTH	LENGTH
65-1135	⅛ in 3 mm	½ in 13 mm	7 in 178 mm



## Pins (Distraction)

### Caspar Distraction Pin

Sold individually

CODE	DIAMETER
57-5106	12 mm
57-5107	14 mm
57-5100	18 mm



57-5100

## Probes (Ball)

### McCulloch Ball Probe

CODE	DESCRIPTION	LENGTH
57-5722	4 mm Angled Tip	9½ in 241 mm
57-5723	7 mm Angled Tip	9½ in 241 mm

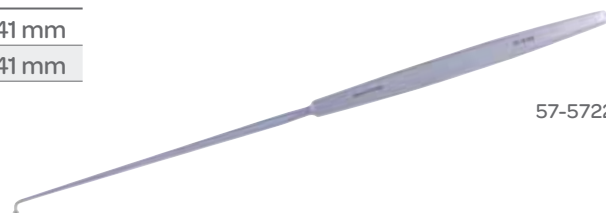

57-5722

## Probes (Foraminal)

### McCulloch Foraminal Probe

CODE	TIP	LENGTH
57-5760	18 mm	9½ in 241 mm



## Probes (Lumbar)

### Lumbar Probe

CODE	DESCRIPTION	LENGTH
46-3144	Spinal Probe	9½ in 241 mm



## Rasps (Bone)

### Miller Bone Rasp

CODE	DESCRIPTION	LENGTH
26-1012	5 mm and 7 mm, Double-Ended	7¼ in 184 mm



### Putti Bone Rasp

Double-Ended Flat Blades, 18 mm Width Tapers to 4 mm One End Curved Up, One End Curved Sideways

CODE	DESCRIPTION	LENGTH
26-1501	Straight and Curved	10½ in 265 mm



### Putti Bone Rasp

Double-Ended, One 10 mm Round Blade Tapers to 4 mm and One 15 mm Half-Round Blade Tapers to 5 mm

CODE	DESCRIPTION	LENGTH
26-1502	Round and Half Round	12 in 305 mm

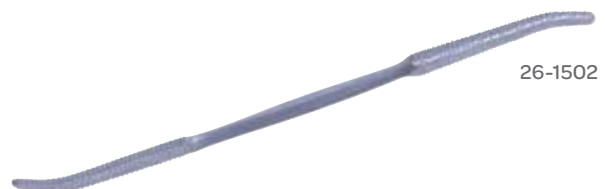

26-1502



## Retractors

### Caspar Retractor

Black Finish

CODE	DESCRIPTION	LENGTH
57-5651-65	Micro Lumbar	65 mm
57-5651-75	Micro Lumbar	75 mm
57-5651-85	Micro Lumbar	85 mm



57-5651-65

### Caspar Retractor

CODE	DESCRIPTION	LENGTH
57-5657F	Counter-Retractor Frame Only	
57-5652	Blade Only	40 mm
57-5653	Blade Only	45 mm
57-5654	Blade Only	50 mm
57-5655	Blade Only	55 mm
57-5656	Blade Only	60 mm
57-5657	Blade Only	65 mm
57-5658	Blade Only	75 mm
57-5658-85	Blade Only	85 mm



57-5657F

### Caspar Type Counter Retractor

CODE	DESCRIPTION	LENGTH
57-5651	Blade Only	35 mm



### Cloward Style Double Hinge Retractor

CODE
57-5602

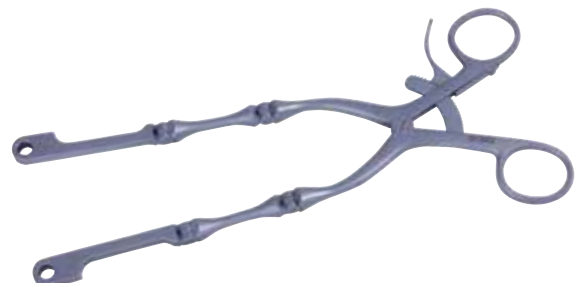

## Retractors

### Hibbs Retractor

CODE	DESCRIPTION	LENGTH
23-6381	1x3 in 25x75 mm	9 in 229 mm



### Horizontal Retractor

CODE	DESCRIPTION	LENGTH
24-3500	4 x 2 Sharp Prongs	12 in 305 mm

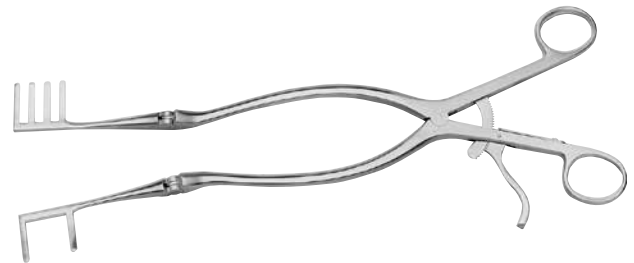

### Markham-Meyerding Retractor

Self-Retaining

CODE	DESCRIPTION	BLADE WIDTH	BLADE DEPTH	TOTAL OPENING	LENGTH
50-1205	Left	1 in 25 mm	2 in 51 mm	3 3/4 in 95 mm	7 in
50-1206	Right	1 in 25 mm	2 in 51 mm	3 3/4 in 95 mm	7 in



50-1205

### Oberhill Retractor

Hinged Blades

CODE	DESCRIPTION	LENGTH
24-3449	4 Prong	13 in 355 mm



## Retractors

### Ribbon Retractor

Double-Ended, Malleable

CODE	WIDTH	LENGTH	CODE	WIDTH	LENGTH
22-0006	¼ in 6 mm	8 in 203 mm	22-0253	1¼ in 32 mm	13 in 330 mm
22-0012	½ in 13 mm	8 in 203 mm	22-0254	1½ in 38 mm	13 in 330 mm
22-0017	⅝ in 16 mm	8 in 203 mm	22-0255	2 in 51 mm	13 in 330 mm
22-0025	1 in 25 mm	8 in 203 mm	22-0256	2½ in 64 mm	13 in 330 mm
22-0027	1 in 25 mm	10 in 254 mm	22-0257	3 in 76 mm	13 in 330 mm
22-0035	1¾ in 44 mm	10 in 254 mm	22-0258	4 in 102 mm	13 in 330 mm
22-0251	¾ in 19 mm	13 in 330 mm	22-0259	5 in 127 mm	13 in 330 mm
22-0252	1 in 25 mm	13 in 330 mm			



22-0006

### Scoville Hook with Bar

CODE	CROSSBAR LENGTH	LENGTH
13-1064	1 in 25 mm	1½ in 38 mm
13-1065	1 in 25 mm	2⅜ in 56 mm
13-1066	1 in 25 mm	2⅝ in 75 mm



13-1064

### Senn Retractor

Double-Ended

CODE	DESCRIPTION	LENGTH
20-0508	Sharp	6¼ in 160 mm
20-0509	Blunt	6¼ in 160 mm



20-0508

# Retractors

## Ultra ReVeal Basic View Retractor System

CODE	DESCRIPTION
59-2000	Complete Set



## Ultra Side Loading Transverse Retractor

CODE	DESCRIPTION	DIMENSION
59-0100	With Double Hinge	120 mm Rack



## Ultra Side-Loading Longitudinal Retractor

CODE	DESCRIPTION	LENGTH
59-0101	With Double Hinge	



## US Army Retractors

Double-Ended

CODE	BLADE WIDTH		BLADE DEPTH		LENGTH
50-4071	1 3/4 in	44 mm	9/16 in	14 mm	8 5/16 in 211 mm
	1 1/4 in	32 mm	9/16 in	14 mm	



## Retractors (ACF)



59-0022

### Ultra ACF Blade

CODE	DESCRIPTION	COLOR	LENGTH
59-0022	ACF Blade, Blunt		20 mm
59-0030	ACF Blade, Blunt	Silver	1 $\frac{1}{8}$ in 30 mm
59-0031	ACF Blade, Blunt	Blue	1 $\frac{3}{8}$ in 35 mm
59-0032	ACF Blade, Blunt	Red	1 $\frac{5}{8}$ in 40 mm
59-0034	ACF Blade, Blunt	Violet	2 in 50 mm
59-0036	ACF Blade, Blunt	Gold	2 $\frac{3}{8}$ in 60 mm
59-0037	ACF Blade, Blunt	Navy	2 $\frac{1}{2}$ in 65 mm
59-0038	ACF Blade, Blunt	Light Green	2 $\frac{3}{4}$ in 70 mm
59-0039	ACF Blade, Blunt	Orange	3 in 75 mm
59-0041	ACF Blade, Blunt		80 mm
59-0055	ACF Micro Blade, Short Teeth	Black	$\frac{9}{16}$ x 1 $\frac{3}{8}$ in 14 x 55 mm
59-0071	ACF Micro Blade, Long Teeth	Black	35 mm
59-0074	ACF Micro Blade, Long Teeth	Violet	50 mm
59-0075	ACF Micro Blade, Long Teeth	Black	55 mm

### Cervical Retractor Blade

#### Lo Pro Blades in Retractor

CODE	DESCRIPTION	LENGTH
59-2010	Pronged	22 x 45 mm
59-2001	Right	

See our retractor section, in this catalog, for a complete line of cervical retractor blades.



59-2010

## Retractors (ACF)

Image Not Available



### Ultra ReVeal Lumbar Instrument System

CODE	DESCRIPTION	DIMENSIONS		QUANTITY
59-1030	Blade Angled Out 15°	$10\frac{0}{11}$ x $1\frac{3}{8}$ in	23 x 35 mm	4
59-1031	Blade Angled Out 15°	$10\frac{0}{11}$ x $1\frac{3}{4}$ in	23 x 45 mm	4
59-1032	Blade Angled Out 15°	$10\frac{0}{11}$ x $2\frac{1}{8}$ in	23 x 55 mm	4
59-1033	Blade Angled Out 15°	$10\frac{0}{11}$ x $2\frac{1}{2}$ in	23 x 65 mm	4
59-1034	Blade Angled Out 15°	$10\frac{0}{11}$ x 3 in	23 x 75 mm	4
59-1035	Blade Angled Out 15°	$10\frac{0}{11}$ x $3\frac{3}{8}$ in	23 x 85 mm	4
59-1036	Blade Angled Out 15°	$10\frac{0}{11}$ x $3\frac{15}{16}$ in	23 x 100 mm	4
59-1037	Blade Angled Out 15°	$10\frac{0}{11}$ x $4\frac{3}{4}$ in	23 x 120 mm	4

## Retractors (Blades)

### Caspar Lateral Blade

With Teeth

CODE	DIMENSIONS (W X L)
57-5668L	55 x 23 mm
57-5669L	60 x 23 mm

Image Not Available



### Caspar Retractor Blade Ejector

CODE	DIMENSIONS (L X W)	NO. OF TEETH	TIP CURVE
57-5690	60 x 60 mm	6	30 mm

Image Not Available



### Cervical Retractor

CODE	DESCRIPTION	LENGTH	
50-1050	18 mm	3 x $4\frac{1}{2}$ in	76 x 114 mm
50-1052	20 mm	3 x $4\frac{1}{2}$ in	76 x 114 mm
50-1053	23 mm	3 x $4\frac{1}{2}$ in	76 x 114 mm



50-1052

## Retractors (Blades)



### Cloward Blade Retractor With Lip

Add "M" to Code Number for Blade without Lip

57-5498

CODE	DESCRIPTION	LENGTH	
57-5497	13 mm	7½ in	191 mm
57-5498	18 mm	7½ in	191 mm
57-5499	20 mm	7½ in	191 mm
57-5500	23 mm	7½ in	191 mm

### Crank Frame Retractor Blade

CODE	DESCRIPTION	LENGTH	
46-3206	Semi Hemi	1¼ x 1¼ in	31 x 31 mm
46-3207	Semi Hemi	2 x 1¼ in	51 x 31 mm
46-3199	Left and Right Pair, Offset	¾ x 1¼ in	19 x 31 mm
46-3200	Left and Right Pair, Offset	¾ x 1¾ in	19 x 44 mm
46-3201	Left and Right Pair, Offset	¾ x 2¼ in	19 x 57 mm
46-3202	Left and Right Pair, Offset	¾ x 3 in	19 x 76 mm
46-3203	Left and Right Pair, Offset	¾ x 3¾ in	19 x 83 mm
46-3204	Left and Right Pair, Offset	¾ x 4 in	19 x 102 mm
46-3205	Left and Right Pair, Offset	2 x 4 in	51 x 102 mm



### Crockard Curved Retractor Blade

CODE	TIP WIDTH	BLADE LENGTH	LENGTH
50-1655	½ in 12 mm	1½ in 38 mm	5 in 127 mm



### Crockard Retractor Blade

CODE	DESCRIPTION	BLADE WIDTH	BLADE LENGTH	LENGTH
50-1654	90°	½ in 20 mm	1½ in 38 mm	5 in 127 mm



## Retractors (Blades)

### Retractor Blade

Set of Two

CODE	DESCRIPTION	LENGTH
46-3197	Left/Right	3 x 2½ in 76 x 64 mm

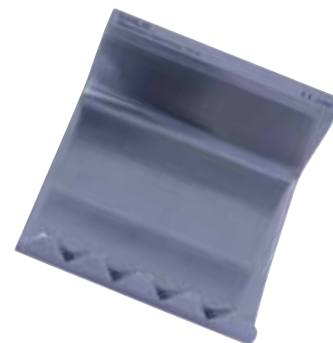

### Retractor Blades for Cervical Retractor Body

CODE	DESCRIPTION	LENGTH
50-1381	Sharp	1 in 25 mm
50-1382	Sharp	1½ in 30 mm
50-1383	Sharp	1¾ in 35 mm
50-1384	Sharp	1⅘ in 40 mm
50-1385	Sharp	1⅚ in 45 mm
50-1386	Sharp	2 50 mm
50-1387	Sharp	2⅕ in 55 mm



50-1383

### Scoville Retractor Blade

CODE	DESCRIPTION	BLADE WIDTH	BLADE DEPTH
13-1009		2 in 51 mm	2½ in 64 mm
13-1008		1 in 25 mm	2½ in 64 mm
13-1010		1⅛ in 29 mm	2⅝ in 67 mm
13-1011		1 in 25 mm	3½ in 89 mm
13-1012	Four Prong	1½ in 38 mm	1⅝ in 41 mm
13-1013	Four Prong	1¾ in 44 mm	2⅝ in 67 mm



13-1013

### Ultra Blade

CODE	DESCRIPTION
59-0105	Loading Locking Retractor Handle





## Retractors (Bookwalter)



### Bookwalter Spinal Retractor Kit, 12 inch Post (305 mm)

CODE	DESCRIPTION	DIMENSIONS	
50-4631	Bookwalter Spinal Retractor Kit includes the following:		
50-4581	Table Post, 1 in (25 mm) Diameter Post		
50-4582	Horizontal Flex Bar		
50-4635	Round Segmented Ring, Small (Pair)	8 ½ in	216 mm
50-4636	Straight Ring Segment (Pair)	4 in	102 mm
50-4637	Straight Ring Segment (Pair)	6 in	152 mm
50-4638	Straight Ring Segment (Pair)	8 in	203 mm
50-4580	Tilt Ratchets (6/each)		
50-4639	Bookwalter Scoville Hook, Small, Qty 2	3 ¼ in	83 mm
50-4640	Bookwalter Scoville Hook, Large, Qty 2	2 in	50 mm
50-4641	Bookwalter-Meyerding Retractor Blade, Small	⅔ x 2 ⅓ in	17 x 60 mm
50-4642	Bookwalter-Meyerding Retractor Blade, Medium	1 x 3 ⅓ in	25 x 85 mm
50-4643	Bookwalter-Meyerding Retractor Blade, Large	2 x 3 ¾ in	50 x 95 mm
50-4645	Bookwalter Rake Retractor-Medium, Rake Retractor, 4 Prong	⅓ x ¾ in	8 ⅔ x 19 mm
50-4646	Bookwalter Rake Retractor-Large, Rake Retractor, 6 Prong	⅓ x 1 in	8 ⅔ x 25 mm
50-4644	Bookwalter Rake Retractor-Deep, Rake Retractor, 3 Prong	¾ x ⅔ in	19 x 17 mm
50-4647	Bookwalter Spinal Retractor, Storage/Sterilizing Case; Depth 4 in (100 mm)	19 ½ x 13 ½ in	500 x 340 mm

## Retractors (Bookwalter)

### Bookwalter Vertical Extension Bar

CODE	DIAMETER	LENGTH
50-4553	1 in 25 mm	12 in 305 mm



## Retractors (Cervical)

### Caspar Cervical Retractor

CODE	DESCRIPTION
57-5660	Rack and Pinion Ratchet
57-5662	Ring Handle, Self-Retaining



### Cervical Retractor

Total Opening: 4 1/2 in (114 mm)

CODE	DESCRIPTION	LENGTH
50-1380	Large with Set of 7 Sharp Blades	10 in 245 mm

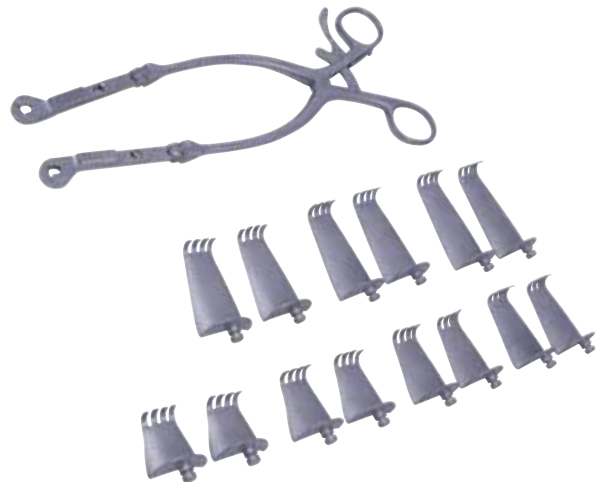

### Cervical Retractor Body

CODE	LENGTH
50-1346	10 in 245 mm



## Retractors (Cervical)

### Cervical Retractor Set

CODE	DESCRIPTION	BLADE DEPTH	LENGTH
50-1390	Cervical Retractor Set Small, Self-Retaining with 7 Pairs of Blunt Blades		6 x $\frac{3}{4}$ in 152 x 95 mm
50-1356	Cervical Retractor Body, Small		
50-1391	Retractor Blade, Blunt	1 in	25 mm
50-1392	Retractor Blade, Blunt	1 $\frac{1}{5}$ in	30 mm
50-1393	Retractor Blade, Blunt	1 $\frac{2}{5}$ in	35 mm
50-1394	Retractor Blade, Blunt	1 $\frac{3}{5}$ in	40 mm
50-1395	Retractor Blade, Blunt	1 $\frac{4}{5}$ in	45 mm
50-1396	Retractor Blade, Blunt	2 in	50 mm
50-1397	Retractor Blade, Blunt	2 $\frac{1}{5}$ in	55 mm



50-1391

### Cervical Tissue Retractor

CODE	DESCRIPTION	BLADE DEPTH
57-5550	Blunt Prongs	13 mm



### Cloward Cervical Retractor

CODE	DESCRIPTION
57-5575	With Ratchet



## Retractors (Crank Frame Spinal Retractor)



### Karlin Crank Frame Spinal Retractor Set

CODE	DESCRIPTION	LENGTH
46-3190	Designed for posterior Lumbar and Thoracic spine surgery. Arm design allows the blades to be pre-positioned in the wound prior to attachment. Blades are interchangeable. Multiple blades may be used on each retractor arm. Maximum width opening 5 ½ in (140 mm) Crank Frame Spinal Retractor Set Includes:	2 ¼ x 2 ½ in    57 x 64 mm
46-3191	Crank Frame Retractor Body	
46-3192	Crank Frame Retractor Ratchet	
46-3193	Blade with Sacral Cutout, Left	1 ¼ x 1 ½ in    31 x 38 mm
46-3194	Blade with Sacral Cutout, Right	1 ¼ x 1 ½ in    31 x 38 mm
46-3195	Blade with Sacral Cutout, Left	2 ¼ x 1 ¾ in    57 x 44 mm
46-3196	Blade with Sacral Cutout, Right	3 x 2 ½ in    57 x 44 mm
46-3197	Blade, Left/Right (2 Blades in Set, 1 with re-order)	1 ¼ x 1 ½ in    76 x 64 mm

## Retractors (Crank Frame Spinal Retractor)

### Single Prong Crank Frame Retractor Blade

CODE	DESCRIPTION	LENGTH	
46-3208	Karlin Prong Retractor Blade	1.5 in	38 mm
46-3209	Karlin Prong Retractor Blade	2 in	51 mm
46-3210	Karlin Prong Retractor Blade	2.5 in	64 mm
46-3211	Karlin Prong Retractor Blade	1.5 in	38 mm
46-3212	Karlin Prong Retractor Blade	2 in	51 mm
46-3213	Karlin Prong Retractor Blade	2.5 in	64 mm



## Retractors (Decompression)

### Cushing Decompression Retractor

CODE	DESCRIPTION	LENGTH	
57-5205	10 x 18	8 in	200 mm



## Retractors (Dural)

### 90° Dural Suction Retractor

CODE	TIP WIDTH	TIP DEPTH	WORKING DISTANCE	LENGTH
46-3012	9/32 in 8 mm	1/4 in 6 mm	4 3/4 in 120 mm	4 3/4 x 4 5/8 in 120 x 117 mm



### Dural Suction Retractor (Micro)

Black Bayonet

CODE	TIP WIDTH	TIP DEPTH	LENGTH
46-3011	1/4 in 6 mm	1/4 in 6 mm	8 1/2 in 216 mm



### Silver Bayonet Dural Suction Retractor

CODE	DESCRIPTION	DEPTH
46-3005	Silver, Bayonet, Macro Tip	7/16 in 10 mm



## Retractors (Hard Palate)

### Crockard Hard Palate Retractor

CODE	TIP WIDTH	LENGTH
50-1659	1 in 25 mm	4 ¼ in 108 mm



## Retractors (Hemilaminectomy)

### Scoville-Haverfiled Hemilaminectomy Retractor

CODE	DESCRIPTION
50-1130	Self-Retaining with Ratchet Action and Hinged Arms, Complete Set

Image Not Available



### Scoville-Haverfiled Hemilaminectomy Retractor Body

CODE	ARM LENGTH	LENGTH
50-1131	5 ¾ in 146 mm	7 in 178 mm



### Scoville Hemilaminectomy Retractor

CODE	DESCRIPTION	SPREAD
50-1125	Self-Retaining	5 in 127 mm



## Retractors (Hemilaminectomy)

### Valin Hemilaminectomy Retractor

CODE	DESCRIPTION	TOTAL OPENING		LENGTH
50-1120	Self-Retaining with Rack and Pinion Action	4 ½ In	114 mm	



### Valin Hemilaminectomy Retractor Body

CODE	DESCRIPTION	LENGTH
50-1121		



## Retractors (Laminectomy)

### Badgley Laminectomy Retractor

CODE	DESCRIPTION	BLADE WIDTH		BLADE DEPTH		LENGTH
50-1255	Self-Retaining	1 ¾ in	44 mm	2 in	51 mm	6 ¾ in 162 mm





## Retractors (Laminectomy)

### Beckman-Adson Laminectomy Retractor

Self-Retaining with Hinged Arms

CODE	DESCRIPTION	BLADE WIDTH		BLADE DEPTH		TOTAL OPENING		LENGTH	
50-1160	Four Prong, Blunt	1 in	25 mm	1¼ in	32 mm	5 in	127 mm	12 in	305 mm
50-1161	Four Prong, Sharp	1 in	25 mm	1 in	25 mm	5 in	127 mm	12 in	305 mm
50-1162	Four Prong, X-Long	1 in	25 mm	1¾ in	44 mm	5½ in	140 mm	12 in	305 mm
50-1163	Seven Pronged Blades	1¾ in	44 mm	1⅞ in	48 mm	5½ in	140 mm	12¾ in	324 mm



50-1160

### Cone Laminectomy Retractor

Self-Retaining with Hinged Arms

CODE	DESCRIPTION	LENGTH	
50-1167	3 x 4 Sharp Prongs	6⅜ in	162 mm
50-1168	3 x 4 Sharp Prongs	8 in	203 mm



50-1167

## Retractors (Laminectomy)

### Meyering Laminectomy Retractor

CODE	DESCRIPTION	BLADE WIDTH		BLADE DEPTH		LENGTH	
23-6301	#1 Small, $\frac{5}{8}$ x 2 x 9 in					9 $\frac{1}{2}$ in	241 mm
23-6302	#2 Medium, 1 x 3 x 9 $\frac{1}{2}$ in					9 $\frac{1}{2}$ in	241 mm
50-1065	Small	$\frac{5}{8}$ in	16 mm	2 in	51 mm	6 $\frac{1}{2}$ in	165 mm
50-1066	Medium	1 in	25 mm	3 in	76 mm	7 $\frac{7}{8}$ in	180 mm
50-1067	Large	2 in	51 mm	3 $\frac{1}{2}$ in	89 mm	9 in	229 mm
24-4530	25 x 30 mm					6 $\frac{1}{2}$ in	165 mm
50-1192	Self Retaining	1 in	25 mm	1 $\frac{3}{4}$ in	44 mm		
50-1191	Self Retaining	1 in	25 mm	2 in	51 mm		
50-1190	Self Retaining	1 in	25 mm	2 $\frac{1}{4}$ in	57 mm	6 $\frac{1}{2}$ in	165 mm



23-6301

### Poppen-Gelpi Laminectomy Retractor

CODE	DESCRIPTION	TOTAL OPENING		LENGTH	
50-1212	Self-Retaining	2 $\frac{1}{2}$ in	64 mm	5 $\frac{1}{2}$ in	140 mm



### Seletz-Gelpi Laminectomy Retractor

CODE	DESCRIPTION	ARM LENGTH		TOTAL OPENING		LENGTH	
50-1211	Self-Retaining with Arms Bent at Right Angles	2 $\frac{9}{16}$ in	65 mm	3 $\frac{3}{4}$ in	95 mm	6 $\frac{1}{4}$ in	159 mm



## Retractors (Laminectomy)

### Taylor Laminectomy Blade

CODE	DESCRIPTION	BLADE WIDTH		BLADE DEPTH	
13-1054	Three Prong	1½ in	38 mm	1¾ in	45 mm
13-1055	Four Prong	2 in	51 mm	1⅞ in	48 mm
13-1056	Four Prong	2¼ in	57 mm	2½ in	64 mm
13-1057	Four Prong	2¼ in	57 mm	3⅞ in	79 mm



13-1054

## Retractors (Lumbar)

### Lumbar Retractor Body

CODE	DESCRIPTION	TOTAL OPENING		LENGTH	
50-1249	Self-Retaining	5 in	127 mm	9 in	229 mm

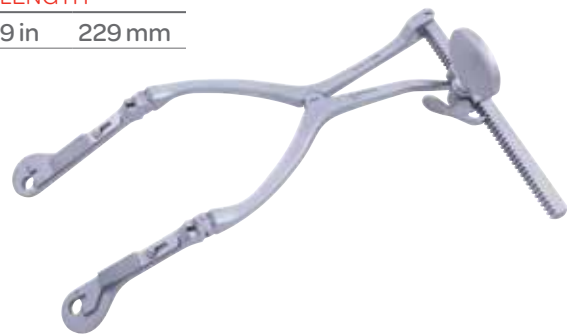

### Scoville Ultra Reveal Lumbar Retractor Body

CODE	DESCRIPTION	SPREAD
59-1104	Double Hinge	8 in 200 mm



## Retractors (McCulloch)

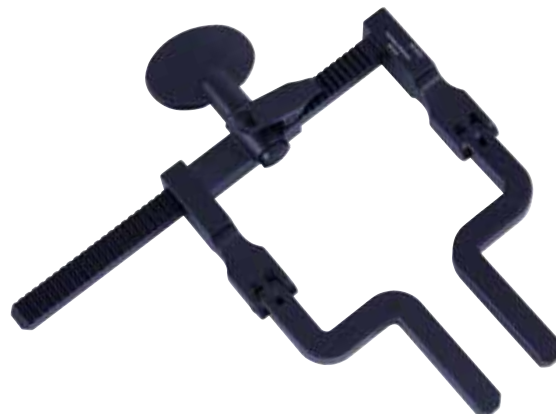

57-5721

### McCulloch Hinged Retractor

Black Finish Blades are for Use with Black Finish Frames

CODE	DESCRIPTION
57-5721	Frame Only, Black Finish
57-5721T	Frame Only, Titanium



57-5720

### McCulloch Rigid Retractor

Frame Only

CODE	DESCRIPTION	LENGTH
57-5720	Black blades Must be Used with the Black Frame	50 mm
57-5720T	Titanium	60 mm

## Retractors (McCulloch)



57-5739

### McCulloch Hook Blade

CODE	BLADE WIDTH	HOOK DEPTH	
57-5738	Black Finish	$\frac{3}{4}$ in	20 mm
57-5739	Black Finish	$1\frac{1}{8}$ in	30 mm
57-5740 mm	Black Finish	$1\frac{1}{2}$ in	40 mm
57-5741	Black Finish	$1\frac{7}{8}$ in	50 mm
57-5742	Black Finish	$2\frac{3}{8}$ in	60 mm
57-5743	Black Finish	$2\frac{3}{4}$ in	70 mm
57-5751	Black Finish	$3\frac{1}{8}$ in	80 mm

Image Not Available



### McCulloch Hook Blade

CODE	DESCRIPTION	HOOK DEPTH	
57-5739T	Titanium	$1\frac{1}{8}$ in	30 mm
57-5740T	Titanium	$1\frac{1}{2}$ in	40 mm
57-5741T	Titanium	$1\frac{7}{8}$ in	50 mm
57-5742T	Titanium	$2\frac{3}{8}$ in	60 mm
57-5743T	Titanium	$2\frac{3}{4}$ in	70 mm
57-5750T	Titanium	$3\frac{1}{8}$ in	80 mm

## Retractors (McCulloch)



### McCulloch Multi-Hooked Blade

Sold Individually

57-5746

CODE	DESCRIPTION	HOOK DEPTH	
57-5744	Black Finish	$\frac{3}{4}$ in	20 mm
57-5745	Black Finish	$1\frac{1}{8}$ in	30 mm
57-5746	Black Finish	$1\frac{1}{2}$ in	40 mm
57-5747	Black Finish	$1\frac{7}{8}$ in	50 mm
57-5748	Black Finish	$2\frac{3}{8}$ in	60 mm
57-5749	Black Finish	$2\frac{3}{4}$ in	70 mm
57-5753	Black Finish	$3\frac{1}{8}$ in	80 mm
57-5752	Black Finish	$3\frac{1}{2}$ in	90 mm

Image Not Available



### McCulloch Multi-Hooked Blade

CODE	DESCRIPTION	HOOK DEPTH	
57-5744T	Titanium	$\frac{3}{4}$ in	20 mm
57-5745T	Titanium	$1\frac{1}{8}$ in	30 mm
57-5746T	Titanium	$1\frac{1}{2}$ in	40 mm
57-5747T	Titanium	$1\frac{7}{8}$ in	50 mm
57-5748T	Titanium	$2\frac{3}{8}$ in	60 mm
57-5749T	Titanium	$2\frac{3}{4}$ in	70 mm

### McCulloch Thin Muscle Blade

Sold individually



57-5793

CODE	DESCRIPTION	BLADE W X D	
57-5793	Black Finish	$\frac{1}{16}$ x $1\frac{1}{2}$ in	17 x 40 mm
57-5794	Black Finish	$\frac{1}{16}$ x $1\frac{7}{8}$ in	17 x 50 mm
57-5795	Black Finish	$\frac{1}{16}$ x $1\frac{3}{8}$ in	17 x 60 mm
57-5796	Black Finish	$\frac{1}{16}$ x $2\frac{3}{4}$ in	17 x 70 mm

## Retractors (McCulloch)



57-5732

### McCulloch Narrow Muscle Retractor Blade

1 Pair

CODE	DESCRIPTION	HOOK DEPTH	
57-5732	Black Finish	¾ in	30 mm
57-5733	Black Finish	1⅛ in	40 mm
57-5734	Black Finish	1½ in	50 mm
57-5735	Black Finish	1⅞ in	60 mm
57-5736	Black Finish	2⅜ in	70 mm
57-5737	Black Finish	2¾ in	80 mm
57-5772	Black Finish	3⅛ in	90 mm
57-5773	Black Finish	3½ in	100 mm
57-5774	Black Finish	4¼ in	110 mm
57-5775	Black Finish	4⅝ in	120 mm

Image Not Available



### McCulloch Narrow Muscle Retractor Blade

1 Pair

CODE	DESCRIPTION	HOOK DEPTH	
57-5732T	Titanium	¾ in	30 mm
57-5733T	Titanium	1⅛ in	40 mm
57-5734T	Titanium	1½ in	50 mm
57-5735T	Titanium	1⅞ in	60 mm
57-5736T	Titanium	2⅜ in	70 mm
57-5737T	Titanium	2¾ in	80 mm
57-5781T	Titanium	3⅛ in	90 mm

## Retractors (McCulloch)



57-5790

### McCulloch Single Cervical Blade

CODE	DESCRIPTION
57-5790-40	2 Teeth, 40 mm
57-5790	2 Teeth, 50 mm
57-5791	2 Teeth, 60 mm
57-5792	2 Teeth, 70 mm



57-5726

### McCulloch Wide Muscle Retractor Blade

2.7 mm Wide

CODE	DESCRIPTION	BLADE DEPTH	
57-5726	Black Finish	¾ in	30 mm
57-5727	Black Finish	1 ⅛ in	40 mm
57-5728	Black Finish	1 ½ in	50 mm
57-5729	Black Finish	1 ⅞ in	60 mm
57-5730	Black Finish	2 ⅜ in	70 mm
57-5731	Black Finish	2 ¾ in	80 mm
57-5783	Black Finish	3 ⅛ in	90 mm
57-5784	Black Finish	3 ½ in	100 mm
57-5785	Black Finish	4 ¼ in	110 mm
57-5786	Black Finish	4 ⅝ in	120 mm



## Retractors (McCulloch)



57-5730T

### McCulloch Wide Muscle Retractor Blade

1 Pair

CODE	DESCRIPTION	BLADE DEPTH	
57-5726T	Titanium	$\frac{3}{4}$ in	30 mm
57-5727T	Titanium	$1\frac{1}{8}$ in	40 mm
57-5728T	Titanium	$1\frac{1}{2}$ in	50 mm
57-5729T	Titanium	$1\frac{7}{8}$ in	60 mm
57-5730T	Titanium	$2\frac{3}{8}$ in	70 mm
57-5731T	Titanium	$2\frac{3}{4}$ in	80 mm
57-5783T	Titanium	$3\frac{1}{8}$ in	90 mm

## Retractors (Medial)



### Cervical Retractor Blade

Stainless Steel, Ball Snap Closure, for use with 57-5759, 57-5760, 57-5761 and 57-5762

CODE	DESCRIPTION
57-5665	Medial Blades with Teeth 40 x 23 mm
57-5666	Medial Blades with Teeth 45 x 23 mm
57-5667	Medial Blades with Teeth 50 x 23 mm
57-5668	Medial Blades with Teeth 55 x 23 mm
57-5669	Medial Blades with Teeth 60 x 23 mm
57-5665L	Lateral Blades with Teeth 40 x 23 mm
57-5666L	Lateral Blades with Teeth 45 x 23 mm
57-5667L	Lateral Blades with Teeth 50 x 23 mm
57-5668L	Lateral Blades with Teeth 55 x 23 mm
57-5669L	Lateral Blades with Teeth 60 x 23 mm

## Retractors (Micro)



59-0080

### Ultra ReVeal ACF Blades

CODE	DESCRIPTION	COLOR	LENGTH	QTY
59-0080	ACF Micro Blade, Blunt	Blue	9/16 x 1 3/8 in 14 x 35 mm	2
59-0081	ACF Micro Blade, Blunt	Red	9/16 x 1 5/8 in 14 x 40 mm	2

## Retractors (Micro Discectomy)

### Williams Micro Discectomy Retractor

CODE	BLADE WIDTH	BLADE LENGTH	LENGTH
80-1650	10 mm	50 mm	6 in 152 mm
80-1651	20 mm	50 mm	6 in 152 mm
80-1652	10 mm	70 mm	6 in 152 mm
80-1653	20 mm	70 mm	6 in 152 mm



80-1650

## Retractors (Microlumbar)

### Williams Microlumbar Discectomy Suction Retractor

CODE	DESCRIPTION	LENGTH
80-1655	16 French	6 in 152 mm



## Retractors (Mid-Facial Osteotomy)

### Crockard Mid-Facial Osteotomy Retractor Plate

CODE	DESCRIPTION	WIDTH	OPENING	WIDTH	LENGTH		
50-1668		1 3/4 in	44 mm	2 in	50 mm	2 1/2 in	64 mm



## Retractors (Nerve Root)

### Campbell Nerve Root Retractor

CODE	DESCRIPTION	BLADE WIDTH	LENGTH		
50-1326	Malleable Shaft	3/8 in	10 mm	8 1/2 in	216 mm



### D'errico Nerve Root Retractor

CODE	DESCRIPTION	BLADE WIDTH	LENGTH		
50-1270		1/4 in	6 mm	9 in	229 mm



### Holsher Nerve Root Retractor

CODE	DESCRIPTION	BLADE WIDTH	LENGTH
50-1331		5/16 x 9 3/4 in	7 x 248 mm



### Love Nerve Root Retractor

CODE	DESCRIPTION	BLADE WIDTH	SHAFT LENGTH	LENGTH	
50-1315	Straight	1/4 in	6 mm	4 in 102 mm	7 5/8 in 194 mm
50-1316	90° Angle	1/4 in	6 mm	4 in 102 mm	3 3/4 in 95 mm
50-1317	135° Angle	1/4 in	6 mm	4 in 102 mm	3 1/4 in 83 mm



50-1315

## Retractors (Nerve Root)

### McCulloch Nerve Root Retractor

CODE	WIDTH	LENGTH
57-5761	6 mm	5 in 127 mm
57-5762	6 mm	5 in 127 mm



### Scoville Nerve Root Retractor

CODE	DESCRIPTION	BLADE WIDTH	LENGTH
50-1291	90°	$\frac{5}{16}$ in 8 mm	4 $\frac{1}{4}$ x 5 in 108 x 127 mm
50-1293	90°	$\frac{1}{2}$ in 13 mm	4 $\frac{1}{4}$ x 5 in 108 x 127 mm



57-5762

### Smith Nerve Root Suction Retractor

With Obturator and Thumb Control For Suction

CODE	DESCRIPTION	TIP WIDTH	TIP DEPTH	SHAFT LENGTH	LENGTH
50-1275		$\frac{1}{4}$ in 6 mm	$\frac{1}{8}$ in 3 mm	5 $\frac{1}{4}$ in 133 mm	7 in 178 mm



50-1291

### Weary Nerve Root Retractor

CODE	BLADE WIDTH	SHAFT LENGTH	HANDLE LENGTH
50-1310	$\frac{7}{16}$ in 11 mm	5 $\frac{3}{4}$ in 146 mm	5 $\frac{3}{4}$ in 146 mm



## Retractors (Pharyngeal)

### Crockard Pharyngeal Retractor

CODE	DESCRIPTION	LENGTH
50-1660	Small	7 in 178 mm
50-1661	Large	7½ in 191 mm



50-1660

## Retractors (Radiolucent)

### Caspar Medial Radiolucent Carbon Fiber Blade

Carbon Fiber Radiolucent Blades, Ball Snap Closure, for Use with Cervical Retractors: 57-5659, 57-5660, 57-5661 and 57-5662.



57-5510B

CODE	DESCRIPTION
57-5510	40 x 23 mm
57-5511	45 x 23 mm
57-5512	50 x 23 mm
57-5513	55 x 23 mm
57-5514	60 x 23 mm
57-5515	65 x 23 mm



57-5523

### Cervical Retractor Blades, Longitudinal Blades, Blunt

Carbon Fiber Radiolucent Blades, Ball Snap Closure

CODE	DESCRIPTION
57-5522	40 x 23 mm
57-5523	45 x 23 mm
57-5524	50 x 23 mm
57-5525	55 x 23 mm
57-5526	60 x 23 mm
57-5527	65 x 23 mm

## Retractors (Sacral)

### Blade with Sacral Cutout

CODE	DESCRIPTION	LENGTH
46-3193	Left	1¼ x 1½ in 31 x 38 mm
46-3195	Left	2¼ x 1¾ in 57 x 44 mm
46-3194	Right	1¼ x 1½ in 31 x 38 mm
46-3196	Right	2¼ x 1¾ in 57 x 44 mm



46-3193

## Retractors (Self-Retaining)

### Adson 4 x 4 Retractor

Total Opening 4 ½ in (114 mm)

CODE	DESCRIPTION	BLADE SIZE	LENGTH
50-1180	Straight Shaft, Sharp Prongs	5⁄8 x 7⁄8 in 16 x 22 mm	7 ½ in 178 mm
50-1182	Straight Shaft, Blunt Prongs	5⁄8 x 7⁄8 in 16 x 22 mm	7 ½ in 178 mm
50-1181	Angular Shaft, Sharp Prongs	5⁄8 x 7⁄8 in 16 x 22 mm	7 ½ in 178 mm

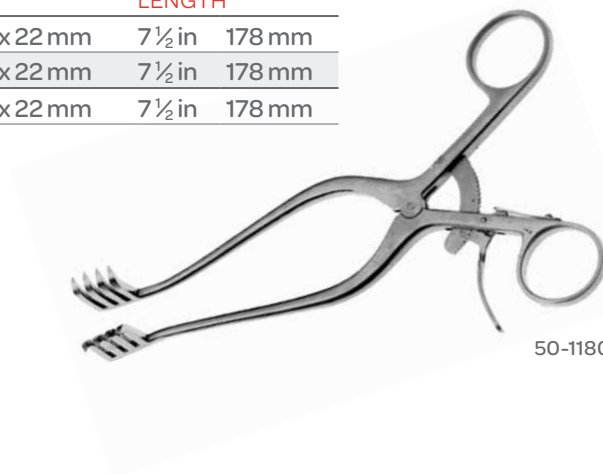

50-1180

### Adson Retractor

Shank Angle 65°

CODE	DESCRIPTION	LENGTH
50-1362	3 x 3 Sharp Prongs	9 ½ in 240 mm



## Retractors (Self-Retaining)

### Weitlaner Retractor

Sharp

CODE	DESCRIPTION	LENGTH	
24-2210	2 x 3	4 ½ in	115 mm
24-2213	3 x 4	5 ½ in	140 mm
24-2216	3 x 4	6 ½ in	165 mm
24-2220	3 x 4	8 in	200 mm
24-2224	3 x 4	9 in	230 mm



24-2210

### Weitlaner Retractor

Blunt

CODE	DESCRIPTION	LENGTH	
24-2211	2 x 3	4 ½ in	115 mm
24-2214	3 x 4	5 ½ in	140 mm
24-2217	3 x 4	6 ½ in	165 mm
24-2221	3 x 4	8 in	200 mm



24-2211

## Retractors (Spinal)

Image Not Available



### Taylor Spinal Retractor

CODE	DESCRIPTION	BLADE WIDTH		BLADE DEPTH		LENGTH	
50-1085	Small	1 ¾ in	30 mm	3 in	76 mm	7 ¼ in	185 mm
50-1086	Large	1 ¼ in	32 mm	4 in	102 mm	7 ¼ in	185 mm

## Retractors (Sternal)

### Himmelstein Sternal Retractor

Self-Retaining with Ratchet Action and Flexible Arms

CODE	DESCRIPTION	BLADE WIDTH	ARM LENGTH	BLADE DEPTH	TOTAL OPENING
50-1133		1 3/8 in 35 mm	5 1/4 in 133 mm	1 1/8 in 29 mm	5 in 127 mm



## Retractors (Tongue)

### Crockard Tongue Retractor Blade

CODE	DESCRIPTION	BLADE LENGTH	LENGTH
50-1653	Small	3 in 76 mm	6 in 152 mm
50-1652	Large	3 1/2 in 91 mm	6 in 152 mm



50-1653

### Crockard Transoral Retractor Body

CODE
50-1651





## Rongeurs

### Beyer Rongeur

CODE	DESCRIPTION	LENGTH
53-1100	Curved, Double Action	7 in 178 mm

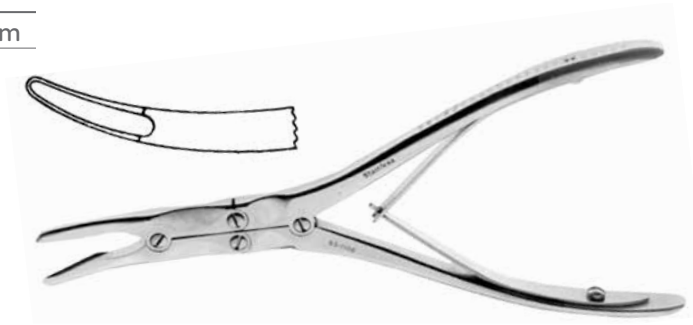

### Caspar Rongeur

CODE	DESCRIPTION	LENGTH
57-2920-1	Angled Down, 2 x 12 mm	7¼ in 185 mm
57-2908	Angled Down, 5 x 14 mm	7½ in 190 mm
57-2905	Angled Up, 3 x 12 mm	7½ in 190 mm
57-2906	Angled Up, 4 x 14 mm	7½ in 190 mm
57-2910	Angled Up, 2 x 12 mm	7¼ in 185 mm

Image Not Available



### Caspar Rongeur

CODE	DESCRIPTION	LENGTH
57-2946	Down, 3 mm	6 in 150 mm
57-2921	Angled Down, 4 x 14 mm	6¼ in 160 mm
57-2919	Angled Up, 5 x 14 mm	6¼ in 160 mm

Image Not Available



### Caspar Rongeur

Angled Up

CODE	DESCRIPTION	LENGTH
57-2910-11	2 x 12 mm	11 in 280 mm
57-2905-11	3 x 12 mm	11 in 280 mm

Image Not Available



# Rongeurs

## Caspar Rongeur

Ceramic Coated

CODE	DESCRIPTION	LENGTH
57-2901-BD	Straight, 2 x 12 mm	7¼ in 185 mm
57-2903-BD	Straight, 4 x 14 mm	7¼ in 185 mm
57-2922-BD	Straight, 2 x 12 mm	9 in 230 mm
57-2930-BD	Down, 2 x 12 mm	9 in 230 mm



## Caspar Rongeur

Straight

CODE	DESCRIPTION	LENGTH
57-2901-11	2 x 12 mm	11 in 280 mm
57-2902-11	3 x 12 mm	11 in 280 mm



## Classic T-F Cervical Rongeur

CODE	DESCRIPTION	LENGTH
53-1537	1 mm	7 in 178 mm



Tip

## Cloward Opti-Length Rongeur

CODE	DESCRIPTION	LENGTH
67-7324	6 x 10 mm Cup	11 in 279 mm



SPINE

## Rongeurs

### Cottle Jansen Rongeur

Angled

CODE	DESCRIPTION	LENGTH
30-5312	12x5 mm Jaws	6 <sup>3</sup> / <sub>4</sub> in 170 mm

Image Not Available



### Cushing Rongeur

1.5x10 mm

CODE	DESCRIPTION	LENGTH
57-2001	Straight	7 in 178 mm
57-1998	Straight, 1.5 mm	9 in 230 mm
57-1999	Down, 1.5 mm	7 in 178 mm
57-2000	Up, 1.5 mm	7 in 178 mm
57-1997	Up, 1.5 mm	9 in 230 mm

Image Not Available



### Decker Rongeur

1.5x5 mm Cups

CODE	DESCRIPTION	LENGTH
57-2098	Straight	5 <sup>1</sup> / <sub>2</sub> in 140 mm
57-2099	Angled Down	5 <sup>1</sup> / <sub>2</sub> in 140 mm
57-2097	Angled Up	5 <sup>1</sup> / <sub>2</sub> in 140 mm

Image Not Available



### Echlin Duckbill Rongeur

Angled

CODE	DESCRIPTION	LENGTH
31-6102	2 x 10 mm Jaws	9 in 230 mm



## Rongeurs

### Ferris Smith-Kerrison Rongeur

CODE	DESCRIPTION	LENGTH
57-1020	40° Up, 2 mm	7 in 175 mm
57-1011	40° Down, 1 mm	7 in 175 mm
57-1470	Straight, 6 x 10 mm	10 in 250 mm
57-1472	Up Biting, 6 x 10 mm	10 in 250 mm

Image Not Available



### Friedman Micro Rongeur

1.5 mm Jaw, Very Delicate

CODE	DESCRIPTION	LENGTH
30-0201	Straight	5½ in 140 mm
30-0202	Curved	5½ in 140 mm



30-0202

### Friedman Rongeur

CODE	DESCRIPTION	LENGTH
30-0203	Straight, 2 mm Jaws	6 in 150 mm
30-0514	Curved, 2.5 mm Jaws	5½ in 140 mm
30-0516	Curved, 4 x 11 mm	5½ in 140 mm
30-0204	Curved, 2 mm Jaws	6 in 150 mm



30-0514

### Leksell Rongeur

Slight Curve Handle

CODE	DESCRIPTION	LENGTH
31-5105	5 mm	9 in 230 mm
31-5108	8 mm	9 in 230 mm



31-5105

## Rongeurs

### Lempert Rongeur

CODE	DESCRIPTION	LENGTH
30-7619	2.5 mm Wide, Straight Jaws	7½ in 190 mm

Image Not Available



### Lempert Rongeur

Bite ¼ in (2 mm)

CODE	DESCRIPTION	LENGTH
53-1108	Straight	6⅞ in 156 mm
53-1102	Curved	6⅞ in 156 mm

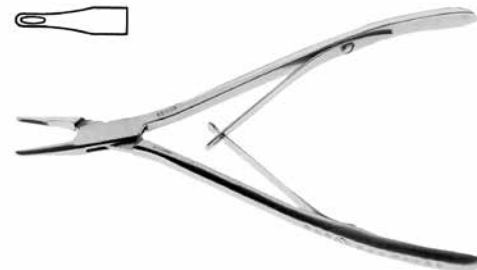

### Lempert Rongeur

Slender Pattern, 2.5 mm Jaws

CODE	DESCRIPTION	LENGTH
30-7620	Straight	6¼ in 160 mm
30-7622	Curved	6¼ in 160 mm

Tip  
30-7622

### Lempert Rongeur

Slender Pattern, 2.5 mm Jaws

CODE	DESCRIPTION	LENGTH
30-7623	Straight	7½ in 190 mm
30-7624	Curved	7½ in 190 mm
30-7625	Curved	7½ in 190 mm



30-7623

### Micro Rongeur

40° Up, Bayonet

CODE	DESCRIPTION	LENGTH
46-2602	2 mm	2¾ in 70 mm
46-2603	3 mm	2¾ in 70 mm

Image Not Available



## Rongeurs

### Opti-Length LUER Laminectomy

Double Action

CODE	DESCRIPTION	LENGTH
67-7906	Curved, 1 mm	14 in 356 mm
67-7907	Curved, 2 mm	14 in 356 mm
67-7908	Curved, 3 mm	14 in 356 mm
67-7909	Curved, 4 mm	14 in 356 mm
67-7910	Curved, 5 mm	14 in 356 mm
67-7911	Curved, 6 mm	14 in 356 mm
67-7918	Full Curve, 1 mm	14 in 356 mm
67-7919	Full Curve, 2 mm	14 in 356 mm
67-7920	Full Curve, 3 mm	14 in 356 mm
67-7921	Full Curve, 4 mm	14 in 356 mm
67-7922	Full Curve, 5 mm	14 in 356 mm
67-7923	Full Curve, 6 mm	14 in 356 mm

Image Not Available



### Ruskin Rongeur

Double Action

CODE	DESCRIPTION	BITE	LENGTH
53-1310	Straight	4 x 33 mm	7¼ in 185 mm
53-1312	Straight	5 x 33 mm	7¼ in 185 mm
53-1311	Curved	4 x 33 mm	7¼ in 185 mm
53-1313	Curved	5 x 33 mm	7¼ in 185 mm



### Semb Stille Rongeur

CODE	DESCRIPTION	LENGTH
31-3153	Curved	9 in 230 mm



53-1310

### Zaufal-Jansen Rongeur

Curved, Double Action

CODE	DESCRIPTION	LENGTH
53-1095	4 x 30 mm	6¾ in 171 mm



## Rongeurs (Black Diamond)

### Black Diamond Micro Kerrison Rongeur

40° Down, Thin Footplate, 9 mm Opening

CODE	DESCRIPTION	LENGTH
57-0801-BD	1 mm	8 in 200 mm
57-0802-BD	2 mm	8 in 200 mm
57-0803-BD	3 mm	8 in 200 mm
57-0804-BD	4 mm	8 in 200 mm
57-0805-BD	5 mm	8 in 200 mm

Image Not Available



## Rongeurs (Bone)

### Luer Bone Rongeur

Bite ¼ in (6 mm)

CODE	DESCRIPTION	LENGTH
30-5217	Straight	7 ½ in 180 mm
53-1011	Curved	7 in 178 mm



30-5217

### Stille-Luer Bone Rongeur

CODE	DESCRIPTION	LENGTH
31-3027	Straight, 17 mm	10 ½ in 265 mm
31-3123	Curved, 10 mm	9 in 230 mm
31-3121	Curved, 10 mm	10 ½ in 265 mm



31-3123

## Rongeurs (Ceramic Coated)

### Ceramic Coated Micro Kerrison Ejector Rongeur

40° Up, with Ejector, 9 mm Opening

CODE	DESCRIPTION	LENGTH	
57-0392-BD	2 mm	7 in	175 mm
57-0393-BD	3 mm	7 in	175 mm
57-0394-BD	3 mm	7 in	175 mm
57-0395-BD	5 mm	7 in	175 mm

Image Not Available



### Ceramic Coated Micro Kerrison Ejector Rongeur

40° Up, with Ejector, 9 mm Opening

CODE	DESCRIPTION	LENGTH	
57-0692-BD	2 mm	8 in	200 mm
57-0693-BD	3 mm	8 in	200 mm
57-0694-BD	4 mm	8 in	200 mm
57-0695-BD	5 mm	8 in	200 mm
57-0696-BD	6 mm	8 in	200 mm

Image Not Available



### Ceramic Coated Spurling Kerrison Rongeur

40° Up, 15 mm Opening

CODE	DESCRIPTION	LENGTH	
57-0582-BD	2 mm	8 in	200 mm
57-0583-BD	3 mm	8 in	200 mm
57-0584-BD	4 mm	8 in	200 mm
57-0585-BD	5 mm	8 in	200 mm

Image Not Available





## Rongeurs (Ceramic Coated)

### Ceramic Coated Micro Kerrison Rongeur

40° Up, 9 mm Opening

CODE	DESCRIPTION	LENGTH	
57-0721-BD	1 mm	7 in	175 mm
57-0722-BD	2 mm	7 in	175 mm
57-0723-BD	3 mm	7 in	175 mm
57-0724-BD	4 mm	7 in	175 mm
57-0725-BD	5 mm	7 in	175 mm
57-0726-BD	6 mm	7 in	175 mm



57-0726-BD

### Ceramic Coated Micro Kerrison Rongeur

40° Up, 9 mm Opening

CODE	DESCRIPTION	LENGTH	
57-0761-BD	1 mm	8 in	200 mm
57-0762-BD	2 mm	8 in	200 mm
57-0763-BD	3 mm	8 in	200 mm
57-0764-BD	4 mm	8 in	200 mm
57-0765-BD	5 mm	8 in	200 mm
57-0766-BD	6 mm	8 in	200 mm

Image Not Available



### Ceramic Coated Micro Kerrison Rongeur

40° Up, 15 mm Opening, Small Handle

CODE	DESCRIPTION	LENGTH	
57-0022-BD	2 mm	8 in	200 mm
57-0023-BD	3 mm	8 in	200 mm
57-0024-BD	4 mm	8 in	200 mm
57-0025-BD	5 mm	8 in	200 mm

Image Not Available



## Rongeurs (Ceramic Coated)

### Ceramic Coated Micro Kerrison Rongeur

40° Up, 9 mm Opening

CODE	DESCRIPTION	LENGTH	
57-0891-BD	1 mm	9 in	230 mm
57-0892-BD	2 mm	9 in	230 mm
57-0893-BD	3 mm	9 in	230 mm
57-0894-BD	4 mm	9 in	230 mm
57-0895-BD	5 mm	9 in	230 mm
57-0896-BD	6 mm	9 in	230 mm

Image Not Available



### Ceramic Coated Micro Kerrison Rongeur

90° Up, Thin Footplate, 9 mm Opening

CODE	DESCRIPTION	LENGTH	
57-0701-BD	1 mm	7 in	175 mm
57-0702-BD	2 mm	7 in	175 mm
57-0703-BD	3 mm	7 in	175 mm
57-0704-BD	4 mm	7 in	175 mm
57-0705-BD	5 mm	7 in	175 mm

Image Not Available



### Ceramic Coated Micro Kerrison Rongeur

90° Up, Thin Footplate, 9 mm Opening

CODE	DESCRIPTION	LENGTH	
57-0739-BD	1 mm	8 in	200 mm
57-0740-BD	2 mm	8 in	200 mm
57-0743-BD	3 mm	8 in	200 mm
57-0744-BD	4 mm	8 in	200 mm

Image Not Available



## Rongeurs (Ceramic Coated)

### Ceramic Coated Micro Kerrison Rongeur

90° Down, Thin Footplate, 9 mm Opening

CODE	DESCRIPTION	LENGTH
57-0751-BD	1 mm	8 in 200 mm
57-0750-BD	2 mm	8 in 200 mm
57-0752-BD	3 mm	8 in 200 mm
57-0754-BD	4 mm	8 in 200 mm
57-0755-BD	5 mm	8 in 200 mm

Image Not Available



## Rongeurs (Cervical)

### Classic T-F Cervical Rongeur

40° Up

CODE	DESCRIPTION	LENGTH
53-1539	1 mm	7 in 178 mm



### Detachable Cervical Rongeur

40° Up

CODE	DESCRIPTION	LENGTH
53-1544	3 mm	7 in 178 mm
53-1546	4 mm	7 in 178 mm

Image Not Available



## Rongeurs (Cervical)

### Kerrison Cervical Rongeur

40° Up, Thin Footplate

CODE	DESCRIPTION	LENGTH
53-1500C	2 mm	6 in 152 mm
53-1503	3 mm	6 in 152 mm
53-1506	4 mm	6 in 152 mm
53-1509	5 mm	6 in 152 mm

Image Not Available



### Kerrison Cervical Rongeur

40° Up, Thin Footplate

CODE	DESCRIPTION	LENGTH
53-1512	2 mm	7 in 178 mm
53-1515	3 mm	7 in 178 mm
53-1518	4 mm	7 in 178 mm
53-1521	5 mm	7 in 178 mm

Image Not Available



### Kerrison Cervical Rongeur

40° Up, Thin Footplate

CODE	DESCRIPTION	LENGTH
53-1524	2 mm	8 in 203 mm
53-1527	3 mm	8 in 203 mm
53-1530	4 mm	8 in 203 mm
53-1533	5 mm	8 in 203 mm

Image Not Available



### Kerrison Cervical Rongeur

90° Down, Thin Footplate

CODE	DESCRIPTION	LENGTH
53-1502	2 mm	6 in 152 mm
53-1505	3 mm	6 in 152 mm
53-1508	4 mm	6 in 152 mm
53-1511	5 mm	6 in 152 mm

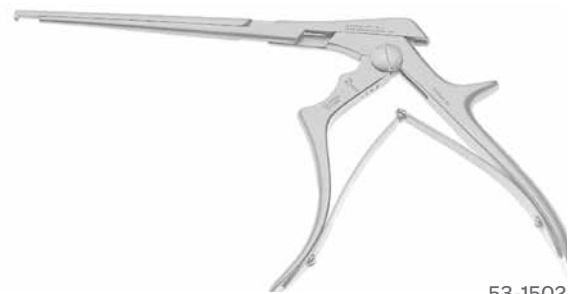

53-1502

## Rongeurs (Cervical)

### Kerrison Cervical Rongeur

90° Down, Thin Footplate

CODE	DESCRIPTION	LENGTH	
53-1514	2 mm	7 in	178 mm
53-1517	3 mm	7 in	178 mm
53-1520	4 mm	7 in	178 mm
53-1523	5 mm	7 in	178 mm

Image Not Available



### Kerrison Cervical Rongeur

90° Down, Thin Footplate

CODE	DESCRIPTION	LENGTH	
53-1526	2 mm	8 in	203 mm
53-1529	3 mm	8 in	203 mm
53-1532	4 mm	8 in	203 mm
53-1535	5 mm	8 in	203 mm

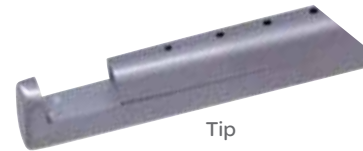

Tip

53-1535

### Kerrison Cervical Rongeur

90° Up, Thin Footplate

CODE	DESCRIPTION	LENGTH	
53-1501	2 mm	6 in	152 mm
53-1504	3 mm	6 in	152 mm
53-1507	4 mm	6 in	152 mm
53-1510	5 mm	6 in	152 mm

Image Not Available



## Rongeurs (Cervical)

### Kerrison Cervical Rongeur

90° Up, Thin Footplate

CODE	DESCRIPTION	LENGTH	
53-1513	2 mm	7 in	178 mm
53-1516	3 mm	7 in	178 mm
53-1519	4 mm	7 in	178 mm
53-1522	5 mm	7 in	178 mm

Image Not Available



### Kerrison Cervical Rongeur

90° Up, Thin Footplate

CODE	DESCRIPTION	LENGTH	
53-1525	2 mm	8 in	203 mm
53-1528	3 mm	8 in	203 mm
53-1531	4 mm	8 in	203 mm
53-1534	5 mm	8 in	203 mm

Image Not Available



### RapidClean Cervical Kerrison Rongeur

40° Up, Detachable

CODE	DESCRIPTION	LENGTH	
53-1540CD	1 mm	7 in	180 mm
53-1542CD	2 mm	7 in	180 mm
53-1544CD	3 mm	7 in	180 mm
53-1546CD	4 mm	7 in	180 mm

Image Not Available



## Rongeurs (Cervical)

### RapidClean Cervical Kerrison Rongeur

40° Up, Detachable

CODE	DESCRIPTION	LENGTH	
53-1570CD	1 mm	8 in	200 mm
53-1572CD	2 mm	8 in	200 mm
53-1574CD	3 mm	8 in	200 mm
53-1576CD	4 mm	8 in	200 mm

Image Not Available



### RapidClean Cervical Kerrison Rongeur

40° Up, Detachable

CODE	DESCRIPTION	LENGTH	
53-1548CD	1 mm	9 in	230 mm
53-1550CD	2 mm	9 in	230 mm
53-1552CD	3 mm	9 in	230 mm
53-1554CD	4 mm	9 in	230 mm

Image Not Available



### Schlesinger Cervical Laminectomy Rongeur

CODE	DESCRIPTION	BITE	LENGTH	
53-1382	Down Biting	3 mm	6 in	152 mm
53-1383	Down Biting	5 mm	6 in	152 mm
53-1380	Up Biting	3 mm	6 in	152 mm
53-1381	Up Biting	5 mm	6 in	152 mm



53-1380

## Rongeurs (Convertible)

### Micro Kerrison Convertible Rongeur

40° Up, Thin Footplate

CODE	DESCRIPTION	LENGTH
58-1180	1 mm	7 in 175 mm
58-2180	2 mm	7 in 175 mm
58-3180	3 mm	7 in 175 mm
58-4180	4 mm	7 in 175 mm
58-5180	5 mm	7 in 175 mm

Image Not Available



### Micro Kerrison Convertible Ejector Rongeur

40° Up, Thin Footplate, with Ejector

CODE	DESCRIPTION	LENGTH
58-3180J	3 mm	7 in 175 mm
58-4180J	4 mm	7 in 175 mm
58-5180J	5 mm	7 in 175 mm

Image Not Available



### Micro Kerrison Convertible Rongeur

40° Up, Regular Footplate

CODE	DESCRIPTION	LENGTH
59-1180	1 mm	7 in 175 mm
59-2180	2 mm	7 in 175 mm
59-3180	3 mm	7 in 175 mm
59-4180	4 mm	7 in 175 mm
59-5180	5 mm	7 in 175 mm

Image Not Available





## Rongeurs (Convertible)

### Micro Kerrison Convertible Rongeur

40° Up, Regular Footplate, with Ejector

CODE	DESCRIPTION	LENGTH	
59-3180J	3 mm	7 in	175 mm
59-4180J	4 mm	7 in	175 mm
59-5180J	5 mm	7 in	175 mm

Image Not Available



### Micro Kerrison Convertible Rongeur

40° Up, Thin Footplate

CODE	DESCRIPTION	LENGTH	
58-1200	1 mm	8 in	203 mm
58-2200	2 mm	8 in	203 mm
58-3200	3 mm	8 in	203 mm
58-4200	4 mm	8 in	203 mm
58-5200	5 mm	8 in	203 mm



58-1200

### Micro Kerrison Convertible Rongeur

40° Up, Regular Footplate

CODE	DESCRIPTION	LENGTH	
59-1200	1 mm	8 in	203 mm
59-2200	2 mm	8 in	203 mm
59-3200	3 mm	8 in	203 mm
59-4200	4 mm	8 in	203 mm
59-5200	5 mm	8 in	203 mm

Image Not Available



## Rongeurs (Convertible)

### Micro Kerrison Convertible Ejector Rongeur

40° Up, Thin Footplate, with Ejector

CODE	DESCRIPTION	LENGTH
58-3200J	3 mm	8 in 203 mm
58-4200J	4 mm	8 in 203 mm
58-5200J	5 mm	8 in 203 mm

Image Not Available



### Micro Kerrison Convertible Ejector Rongeur

40° Up, Regular Footplate, with Ejector

CODE	DESCRIPTION	LENGTH
59-3200J	3 mm	8 in 203 mm
59-4200J	4 mm	8 in 203 mm
59-5200J	5 mm	8 in 203 mm

Image Not Available



### Ceramic Coated Micro Kerrison Convertible Rongeur

40° Up, Thin Footplate

CODE	DESCRIPTION	LENGTH
58-1180-BD	1 mm	7 in 175 mm
58-2180-BD	2 mm	7 in 175 mm
58-3180-BD	3 mm	7 in 175 mm
58-4180-BD	4 mm	7 in 175 mm
58-5180-BD	5 mm	7 in 175 mm



## Rongeurs (Convertible)

### Ceramic Coated Micro Kerrison Convertible Rongeur

40° Up, Regular Footplate

CODE	DESCRIPTION	LENGTH
59-1180-BD	1 mm	7 in 175 mm
59-2180-BD	2 mm	7 in 175 mm
59-3180-BD	3 mm	7 in 175 mm
59-4180-BD	4 mm	7 in 175 mm
59-5180-BD	5 mm	7 in 175 mm

Image Not Available



### Ceramic Coated Micro Kerrison Convertible Rongeur

40° Up, Thin Footplate

CODE	DESCRIPTION	LENGTH
58-1200-BD	1 mm	8 in 200 mm
58-2200-BD	2 mm	8 in 200 mm
58-3200-BD	3 mm	8 in 200 mm
58-4200-BD	4 mm	8 in 200 mm
59-5200-BD	5 mm	8 in 200 mm

Image Not Available



### Black Diamond Micro Kerrison Convertible Rongeur

40° Up, Regular Footplate

CODE	DESCRIPTION	LENGTH
59-1200-BD	1 mm	8 in 200 mm
59-2200-BD	2 mm	8 in 200 mm
59-3200-BD	3 mm	8 in 200 mm
59-4200-BD	4 mm	8 in 200 mm
59-5200-BD	5 mm	8 in 200 mm

Image Not Available



## Rongeurs (Convertible)

### Micro Kerrison Convertible Ejector Rongeur

40° Up, Thin Footplate

CODE	DESCRIPTION	LENGTH
58-1230	1 mm	9 in 230 mm
58-2230	2 mm	9 in 230 mm
58-3230	3 mm	9 in 230 mm
58-4230	4 mm	9 in 230 mm
58-5230	5 mm	9 in 230 mm

Image Not Available

### Micro Kerrison Convertible Ejector Rongeur

40° Up, Regular Footplate

CODE	DESCRIPTION	LENGTH
59-1230	1 mm	9 in 230 mm
59-2230	2 mm	9 in 230 mm
59-3230	3 mm	9 in 230 mm
59-4230	4 mm	9 in 230 mm
59-5230	5 mm	9 in 230 mm

Image Not Available

### Micro Kerrison Convertible Ejector Rongeur

40° Up, Thin Footplate

CODE	DESCRIPTION	LENGTH
58-3230 J	3 mm	9 in 230 mm
58-4230 J	4 mm	9 in 230 mm
58-5230 J	5 mm	9 in 230 mm

Image Not Available

### Micro Kerrison Convertible Ejector Rongeur

40° Up, Regular Footplate, with Ejector

CODE	DESCRIPTION	LENGTH
59-3230 J	3 mm	9 in 230 mm
59-4230 J	4 mm	9 in 230 mm
59-5230 J	5 mm	9 in 230 mm

Image Not Available

## Rongeurs (Convertible)

### Ceramic Coated Micro Kerrison Convertible Rongeur

40° Up, Thin Footplate

CODE	DESCRIPTION	LENGTH
58-1230-BD	1 mm	9 in 230 mm
58-2230-BD	2 mm	9 in 230 mm
58-3230-BD	3 mm	9 in 230 mm
58-4230-BD	4 mm	9 in 230 mm
58-5230-BD	5 mm	9 in 230 mm

Image Not Available



### Ceramic Coated Micro Kerrison Convertible Rongeur

40° Up, Regular Footplate

CODE	DESCRIPTION	LENGTH
59-1230-BD	1 mm	9 in 230 mm
59-2230-BD	2 mm	9 in 230 mm
59-3230-BD	3 mm	9 in 230 mm
59-4230-BD	4 mm	9 in 230 mm
59-5230-BD	5 mm	9 in 230 mm

Image Not Available



### Ceramic Coated Micro Kerrison Convertible Rongeur

40° Up, 15 mm Opening

CODE	DESCRIPTION	LENGTH
58-2262-BD	2 mm	8 in 200 mm
58-2262-BD	3 mm	8 in 200 mm
58-2264-BD	4 mm	8 in 200 mm
58-2265-BD	5 mm	8 in 200 mm

Image Not Available



### Micro Kerrison Convertible Rongeur

40° Up, 15 mm Opening

CODE	DESCRIPTION	LENGTH
58-2262	2 mm	8 in 200 mm
58-2263	3 mm	8 in 200 mm
58-2264	4 mm	8 in 200 mm
58-2265	5 mm	8 in 200 mm

Image Not Available



## Rongeurs (Cranial)

### Adson Cranial Rongeur

Straight

CODE	DESCRIPTION	LENGTH
53-1040	8 mm	8 in 203 mm



### Bacon Cranial Rongeur

Angular

CODE	BITE	LENGTH
53-1035	$\frac{3}{16}$ in 5 mm	7 $\frac{3}{4}$ in 197 mm



## Rongeurs (Detachable Kerrison)

### Classic Detachable Kerrison Rongeur

40° Up Biting, Thin (Cervical) Foot Plate

CODE	DESCRIPTION	LENGTH	
53-1536FD	0.6 mm	7 in	178 mm
53-1537FD	1 mm	7 in	178 mm
53-1512FD	2 mm	7 in	178 mm
53-1515FD	3 mm	7 in	178 mm
53-1518FD	4 mm	7 in	178 mm
53-1538FD	0.6 mm	8 in	200 mm
53-1539FD	1 mm	8 in	200 mm
53-1524FD	2 mm	8 in	200 mm
53-1527FD	3 mm	8 in	200 mm

Image Not Available



### Classic Detachable Kerrison Rongeur

40° Up Biting, Ejector, Thin (Cervical) Foot Plate

CODE	DESCRIPTION	LENGTH	
53-1512FAD	2 mm	7 in	178 mm
53-1515FAD	3 mm	7 in	178 mm
53-1518FAD	4 mm	7 in	178 mm
53-1521FAD	5 mm	7 in	178 mm

Image Not Available



### Classic Detachable Kerrison Rongeur

40° Up Biting, Ejector, Lumbar Foot Plate

CODE	DESCRIPTION	LENGTH	
53-1512LAD	2 mm	7 in	178 mm
53-1515LAD	3 mm	7 in	178 mm
53-1521LAD	5 mm	7 in	178 mm

Image Not Available



## Rongeurs (Detachable Kerrison)

### Classic Detachable Kerrison Rongeur

40° Up Biting, Ejector, Lumbar Foot Plate

CODE	DESCRIPTION	LENGTH	
53-1527LAD	3 mm	8 in	200 mm
53-1530LAD	4 mm	8 in	200 mm
53-1533LAD	5 mm	8 in	200 mm

Image Not Available



### Classic Detachable Kerrison Rongeur

40° Up Biting

CODE	DESCRIPTION
53-1512HD	Bayonet Style
53-1537HD	Bayonet Style

Image Not Available



## Rongeurs (Discectomy)

### Williams Discectomy Rongeur

CODE	DESCRIPTION	LENGTH	
57-2091	2 mm Cup	5½ in	140 mm





## Rongeurs (Ejector)

### Micro Kerrison Ejector Rongeur

40° Up, with Ejector, 9 mm Opening

CODE	DESCRIPTION	LENGTH	
57-0392	2 mm	7 in	175 mm
57-0393	3 mm	7 in	175 mm
57-0394	4 mm	7 in	175 mm
57-0395	5 mm	7 in	175 mm
57-0396	6 mm	7 in	175 mm

Image Not Available



### Micro Kerrison Ejector Rongeur

40°, 9 mm Opening

CODE	DESCRIPTION	LENGTH	
57-0692	2 mm	8 in	200 mm
57-0693	3 mm	8 in	200 mm
57-0694	4 mm	8 in	200 mm
57-0695	5 mm	8 in	200 mm
57-0696	6 mm	8 in	200 mm



57-0692

### Micro Kerrison T-Bar Ejector Rongeur

40° Up, Thin Footplate, Small Handle, 9 mm Opening

CODE	DESCRIPTION	LENGTH	
57-0852	2.5 mm	8 in	200 mm
57-0853	3 mm	8 in	200 mm
57-0854	4 mm	8 in	200 mm
57-0855	5 mm	8 in	200 mm

Image Not Available



## Rongeurs (Intervertebral Disc)

### Cushing Intervertebral Disc Rongeur

Straight

CODE	DESCRIPTION	LENGTH	
53-1290	Cup Shaped Jaws, 2 x 10 mm Cup	5 in	127 mm
53-1195	Cup Shaped Jaws, 2 x 10 mm Cup	6 in	152 mm
53-1230	Cup Shaped Jaws, 2 x 10 mm Cup	7 in	178 mm
57-2012	2 x 10 mm	6 in	155 mm
57-2022	2 x 10 mm	7 in	175 mm
57-2060	2 x 10 mm	9 in	230 mm
57-2023	2 x 10 mm	10 in	250 mm
57-2036	2 x 10 mm	12 in	305 mm
57-2122	2 x 10 mm Jaws, with Teeth	7 in	178 mm



53-1290

### Cushing Intervertebral Disc Rongeur

Curved Down

CODE	DESCRIPTION	LENGTH	
53-1292	Cup Shaped Jaws, 2 x 10 mm Cup	5 in	127 mm
53-1197	Cup Shaped Jaws, 2 x 10 mm Cup	6 in	152 mm
53-1233	Cup Shaped Jaws, 2 x 10 mm Cup	7 in	178 mm



### Cushing Intervertebral Disc Rongeur

Curved Up

CODE	DESCRIPTION	LENGTH	
53-1291	Cup Shaped Jaws, 2 x 10 mm Cup	5 in	127 mm
53-1196	Cup Shaped Jaws, 2 x 10 mm Cup	6 in	152 mm
53-1232	Cup Shaped Jaws, 2 x 10 mm Cup	7 in	178 mm



## Rongeurs (Intervertebral Disc)

### Cushing Intervertebral Disc Rongeur

Angled Down

CODE	DESCRIPTION	LENGTH
57-2062	2 x 10 mm	5 in 125 mm
57-2082	2 x 10 mm	7 in 178 mm
57-2065	2 x 10 mm	9 in 230 mm
57-2182	2 x 10 mm Jaws, with Teeth	7 in 178 mm

Image Not Available



### Cushing Intervertebral Disc Rongeur

Angled Up

CODE	DESCRIPTION	LENGTH
57-2042	2 x 10 mm	6 in 150 mm
57-2052	2 x 10 mm	7 in 178 mm
57-2063	2 x 10 mm	9 in 230 mm
57-2033	2 x 10 mm	11 in 280 mm
57-2152	2 x 10 mm Jaws, with Teeth	7 in 178 mm

Image Not Available



### Delicate Intervertebral Disc Rongeur

CODE	DESCRIPTION	LENGTH
53-1250	Straight, Cup 3 x 10 mm	6 in 152 mm
67-7319	Straight, 3 x 10 mm	11 in 280 mm
67-7321	Straight, 4 x 10 mm	11 in 280 mm
53-1252	Curved Down, Cup 3 x 10 mm	6 in 152 mm
53-1251	Curved Up, Cup 3 x 10 mm	6 in 152 mm
67-7320	30 Degree Up Bite, 3 x 10 mm	11 in 280 mm
67-7322	30 Degree Up Bite, 4 x 10 mm	11 in 280 mm



53-1252

### Caspar IVD Rongeur

Straight

CODE	DESCRIPTION	LENGTH
57-2912	2 x 12 mm	6 ¼ in 160 mm
57-2913	3 x 12 mm	6 ¼ in 160 mm
57-2915	5 x 12 mm	6 ¼ in 160 mm

Image Not Available



## Rongeurs (Intervertebral Disc)

### Caspar IVD Rongeur

Straight

CODE	DESCRIPTION	LENGTH
57-2901	2 x 12 mm	7¼ in 185 mm
57-2902	3 x 12 mm	7¼ in 185 mm
57-2903	4 x 12 mm	7¼ in 185 mm
57-2904	5 x 12 mm	7¼ in 185 mm



57-2901

### Ferris-Smith Intervertebral Disc Rongeur

Straight

CODE	DESCRIPTION	LENGTH
53-1159	Cup 2 x 10 mm	7 in 178 mm
53-1162	Cup 3 x 10 mm	7 in 178 mm
53-1165	Cup 4 x 10 mm	7 in 178 mm
67-7323	Cup 3 x 10 mm	11 in 280 mm
67-7324	Cup 6 x 10 mm	11 in 280 mm



53-1159

### Ferris-Smith Intervertebral Disc Rongeur

Down

CODE	DESCRIPTION	LENGTH
57-1420	2 x 10 mm	7 in 178 mm



### Ferris-Smith Intervertebral Disc Rongeur

Up

CODE	DESCRIPTION	LENGTH
57-1320	2 x 10 mm	7 in 178 mm
57-1340	4 x 10 mm	7 in 178 mm



### Ferris-Smith Intervertebral Disc Rongeur

Curved Down

CODE	DESCRIPTION	LENGTH
53-1161	Cup 2 x 10 mm	7 in 178 mm
53-1164	Cup 3 x 10 mm	7 in 178 mm
53-1167	Cup 4 x 10 mm	7 in 178 mm



## Rongeurs (Intervertebral Disc)

### Ferris-Smith Intervertebral Disc Rongeur

Curved Up

CODE	DESCRIPTION	LENGTH	
53-1160	Cup 2 x 10 mm	7 in	178 mm
53-1163	Cup 3 x 10 mm	7 in	178 mm
53-1166	Cup 4 x 10 mm	7 in	178 mm

Image Not Available



### Hoen Intervertebral Disc Rongeur

Fenestrated

CODE	DESCRIPTION	LENGTH	
57-2095	Straight, 4 mm Jaw, 1 x 2 Teeth	5½ in	140 mm
53-1224	Fenestrated Jaws, Cup 4 x 12 mm	5½ in	140 mm



53-1224

### Intervertebral Disc Rongeur

6 x 10 mm Cup

CODE	DESCRIPTION	LENGTH	
53-1221	Straight	6 in	152 mm
53-1223	Curved Down	6 in	152 mm
53-1222	Curved Up	6 in	152 mm



53-1221

### Intervertebral Disc Rongeur

CODE	CUP SIZE	LENGTH	
53-1171	4 x 8 mm	7 in	178 mm
53-1220	6 x 10 mm	7 in	178 mm
53-1225	6 x 12 mm	7 in	178 mm



53-1171

## Rongeurs (Intervertebral Disc)

### Love-Gruenwald Intervertebral Disc Rongeur

Straight

CODE	DESCRIPTION	LENGTH	
53-1295	Cup Shaped Jaw, 3x10 mm	5 in	127 mm
53-1200	Cup Shaped Jaw, 3x10 mm	6 in	152 mm
53-1235	Cup Shaped Jaw, 3x10 mm	7 in	178 mm
57-2103	3x10 mm	5 in	127 mm
57-2123	3x10 mm	7 in	178 mm
57-2070	3x10 mm	9 in	230 mm
57-2040	3x10 mm	11 in	280 mm
57-2076	3x10 mm	12 in	305 mm
57-2066	3x10 mm, with Teeth	7 in	178 mm



57-2103

### Love-Gruenwald Intervertebral Disc Rongeur

Curved Up

CODE	DESCRIPTION	LENGTH	
53-1296	Cup Shaped Jaw, 3x10 mm	5 in	127 mm
53-1201	Cup Shaped Jaw, 3x10 mm	6 in	152 mm
53-1236	Cup Shaped Jaw, 3x10 mm	7 in	178 mm



### Love-Gruenwald Intervertebral Disc Rongeur

Curved Down

CODE	DESCRIPTION	LENGTH	
53-1297	Cup Shaped Jaw, 3x10 mm	5 in	127 mm
53-1202C	Cup Shaped Jaw, 3x10 mm	6 in	152 mm
53-1237	Cup Shaped Jaw, 3x10 mm	7 in	178 mm



## Rongeurs (Intervertebral Disc)

### Love-Gruenwald Intervertebral Disc Rongeur

Angled Up

CODE	DESCRIPTION	LENGTH
57-2133	3 x 10 mm	5 in 125 mm
57-2153	3 x 10 mm	7 in 175 mm
57-2073	3 x 10 mm	9 in 230 mm
57-2043	3 x 10 mm	11 in 280 mm

Image Not Available



### Love-Gruenwald Intervertebral Disc Rongeur

Angled Down

CODE	DESCRIPTION	LENGTH
57-2163	3 x 10 mm	5 in 125 mm
57-2075	3 x 10 mm	9 in 230 mm

Image Not Available



### Love-Gruenwald Intervertebral Disc Rongeur

Angled Up

CODE	DESCRIPTION	LENGTH
57-2013	3 x 10 mm	6 in 150 mm

Image Not Available



### Love-Gruenwald Opti-Length Rongeur, IVD

3 x 10 Cup

CODE	DESCRIPTION	LENGTH
67-7319	Straight	11 in 279 mm
67-7320	30° Up	11 in 279 mm

Image Not Available



## Rongeurs (Intervertebral Disc)

### Oldberg Intervertebral Disc Rongeur

CODE	DESCRIPTION	LENGTH
53-1262	Cup 6 mm	7 in 178 mm



### Peapod Intervertebral Disc Rongeur

CODE	DESCRIPTION	LENGTH
57-2092	Angled Up, 3 mm	5½ in 140 mm
57-2094	Angled Up, 4 mm	5½ in 140 mm
53-1255	Curved Up, Cup 2 x 6 mm	5½ in 140 mm



53-1255

### Schlesinger Intervertebral Disc Rongeur

Straight, Serrated Cup

CODE	JAWS	LENGTH
53-1190	2 mm	6 in 152 mm
53-1191	3 mm	6 in 152 mm
53-1192	4 mm	6 in 152 mm



53-1190

### Schlesinger Intervertebral Disc Rongeur

Angled Up

CODE	DESCRIPTION	LENGTH
57-2435	3 x 10 mm	5 in 125 mm





## Rongeurs (Intervertebral Disc)

### Selverstone Intervertebral Disc Rongeur

Straight

CODE	DESCRIPTION	LENGTH
53-1325	Cup 2 x 3 mm	6 in 152 mm
53-1326	Cup 2 x 5 mm	6 in 152 mm



53-1325

### Spence Intervertebral Disc Rongeur

Straight

CODE	DESCRIPTION	LENGTH
53-1258	Fenestrated Jaw, Cup 3 x 10 mm	6½ in 165 mm



### Spurling IVD Rongeur

Straight

CODE	DESCRIPTION	LENGTH
57-2461	3 x 10 mm, Fenestrated Jaw	5½ in 140 mm



### Spurling Intervertebral Disc Rongeur

Straight

CODE	DESCRIPTION	LENGTH
53-1300	Cup 4 x 10 mm	5 in 127 mm



## Rongeurs (Intervertebral Disc)

### Spurling Opti-Length Rongeur, IVD

Straight #1

CODE	DESCRIPTION	LENGTH
53-1280	5 x 15 mm	5½ in 140 mm
53-1281	5½ x 15 mm	5½ in 140 mm
53-1282	6 x 15 mm	5½ in 140 mm



53-1280

### Spurling Intervertebral Disc Rongeur

Cup 4 x 10 mm

CODE	DESCRIPTION	LENGTH
53-1210	Straight	6 in 152 mm
53-1240	Straight	6 in 152 mm
53-1212	Curved Down	6 in 152 mm
53-1211	Curved Up	6 in 152 mm



53-1240

### Spurling Intervertebral Disc Rongeur

Cup 4 x 10 mm

CODE	DESCRIPTION	LENGTH
53-1242	Curved Down	7 in 178 mm
53-1241	Curved Up	7 in 178 mm



### Spurling Intervertebral Disc Rongeur

4 x 10 mm Jaws, with Teeth

CODE	DESCRIPTION	LENGTH
57-2300	Straight	7 in 175 mm
57-2302	Angled Down	7 in 175 mm



## Rongeurs (Intervertebral Disc)

### Spurling Opti-Length Rongeur, IVD

Fenestrated Jaw

CODE	DESCRIPTION	LENGTH	
57-2473	Straight, 5 mm	7 in	178 mm
57-2477	Angled Up, 4 mm	7 in	178 mm

Image Not Available



### Spurling Opti-Length Rongeur, IVD

Straight

CODE	DESCRIPTION	LENGTH	
57-2493	Fenestrated Jaw	9 in	230 mm

Image Not Available



### Spurling Opti-Length Rongeur, IVD

Cup 4 x 10 mm

CODE	DESCRIPTION	LENGTH	
67-7321	Straight	11 in	279 mm
67-7322	Up	11 in	279 mm

Image Not Available



## Rongeurs (Laminectomy)

### Echlin Laminectomy Rongeur

Angular, Double Action

CODE	DESCRIPTION	LENGTH	
53-1045	2 mm	8 <sup>3</sup> / <sub>4</sub> in	222 mm
53-1046	3 mm	8 <sup>3</sup> / <sub>4</sub> in	222 mm
53-1047	4 mm	8 <sup>3</sup> / <sub>4</sub> in	222 mm



53-1045

## Rongeurs (Laminectomy)

### Ferris-Smith Kerrison Rongeur

CODE	DESCRIPTION	LENGTH	
53-1158	Down Biting, 5 mm	6 in	152 mm
53-1157	Up Biting, 5 mm	6 in	152 mm
67-7323		11 in	



53-1157

### Fulton Laminectomy Rongeur

Double Action, Cup Size 15 x 16 mm, Narrow Blade

CODE	DESCRIPTION	LENGTH	
53-1060	Straight	7½ in	191 mm
53-1066	Straight	9½ in	241 mm
53-1061	Slightly Curved	7½ in	191 mm
53-1067	Slightly Curved	9½ in	241 mm



53-1060

### Kerrison Laminectomy Rongeur

Down Biting Shaft

CODE	DESCRIPTION	LENGTH	
53-1374	3 mm	6 in	152 mm
53-1375	5 mm	6 in	152 mm
53-1376	3 mm	7½ in	191 mm
53-1377	5 mm	7½ in	191 mm



## Rongeurs (Laminectomy)

### Kerrison Laminectomy Rongeur

40° Up

CODE	DESCRIPTION	LENGTH
53-1385	3 mm	6 in 152 mm
53-1386	5 mm	6 in 152 mm
53-1387	3 mm	7½ in 191 mm
53-1388	5 mm	7½ in 191 mm



53-1386

### Kerrison Laminectomy Rongeur

Up Biting Shaft

CODE	DESCRIPTION	LENGTH
53-1370	3 mm	6 in 152 mm
53-1371	5 mm	6 in 152 mm
53-1372	3 mm	7½ in 191 mm
53-1373	5 mm	7½ in 191 mm



53-1370

### Laminectomy Rongeur

40° Up

CODE	DESCRIPTION	LENGTH
51-1085	3 mm	6⅞ in 174 mm
51-1086	5 mm	6⅞ in 174 mm
51-1087	3 mm	8 in 203 mm
51-1088	5 mm	8 in 203 mm



51-1085

## Rongeurs (Laminectomy)

### Leksell Laminectomy Rongeur

Double Action, 8 mm

CODE	DESCRIPTION	LENGTH
53-1127	Regular Curve, Narrow Bite	9 in 229 mm
53-1125	Regular Curve, Wide Jaw	9 in 229 mm
53-1128	Full Curve, Narrow Bite	9 in 229 mm
53-1126	Full Curve, Wide Jaw	9 in 229 mm

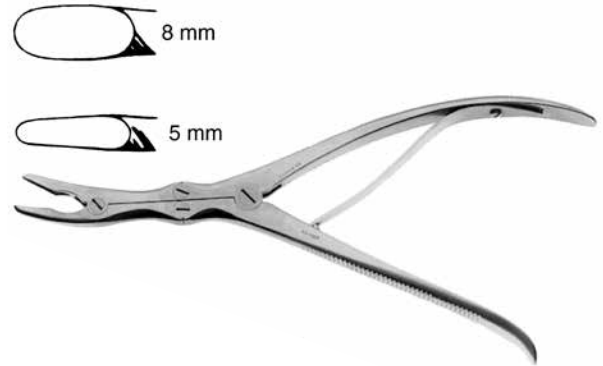

53-1127

### Leksell Laminectomy Rongeur

Double Action

CODE	DESCRIPTION	LENGTH
67-7900	Regular Curve, 1 mm	14 in 356mm
67-7901	Regular Curve, 2 mm	14 in 356 mm
67-7902	Regular Curve, 3 mm	14 in 356 mm
67-7903	Regular Curve, 4 mm	14 in 356 mm
67-7904	Regular Curve, 5 mm	14 in 356 mm
67-7905	Regular Curve, 6 mm	14 in 356 mm
67-7912	Full Curve, 1 mm	14 in 356 mm
67-7913	Full Curve, 2 mm	14 in 356 mm
67-7914	Full Curve, 3 mm	14 in 356 mm
67-7915	Full Curve, 4 mm	14 in 356 mm
67-7916	Full Curve, 5 mm	14 in 356 mm
67-7917	Full Curve, 6 mm	14 in 356 mm



677917

### Reiner Rongeur

Curved

CODE	BITE	LENGTH
53-1015	3 x 13 mm	7 in 178 mm
53-1016	4 x 14 mm	7 in 178 mm



53-1015

## Rongeurs (Laminectomy)

### Raney Laminectomy Rongeurs

CODE	DESCRIPTION	LENGTH
51-1066	7 mm	7½ in 191 mm



### Smith-Peterson Laminectomy Rongeur

Double Action

CODE	DESCRIPTION	LENGTH
53-1080	Straight, 4 x 15 mm	7½ in 191 mm
53-1083	Straight	9½ in 241 mm
53-1081	Slightly Curved, 4 x 15 mm	7½ in 191 mm
53-1084	Slightly Curved	9½ in 241 mm
53-1085	Full Curve	9½ in 241 mm



53-1080

## Rongeurs (Lumbar)

### Kerrison Lumbar Rongeur

40° Up, Hardy Style Handle with Ball Spring

CODE	DESCRIPTION	LENGTH
53-1402	3 mm	7 in 178 mm
53-1405	4 mm	7 in 178 mm
53-1408	5 mm	7 in 178 mm
53-1411	6 mm	7 in 178 mm



53-1402

### Kerrison Lumbar Rongeur

90° Down, Hardy Style Handle with Ball Spring

CODE	DESCRIPTION	LENGTH
53-1404	3 mm	7 in 178 mm
53-1407	4 mm	7 in 178 mm
53-1410	5 mm	7 in 178 mm
53-1413	6 mm	7 in 178 mm



Image Not Available

### Kerrison Lumbar Rongeur

90° Up, Hardy Style Handle with Ball Spring

CODE	DESCRIPTION	LENGTH
53-1403	3 mm	7 in 178 mm
53-1406	4 mm	7 in 178 mm
53-1409	5 mm	7 in 178 mm
53-1412	6 mm	7 in 178 mm



Image Not Available

### Kerrison Lumbar Rongeur

40° Up, Hardy Style Handle with Ball Spring

CODE	DESCRIPTION	LENGTH
53-1414	3 mm	8 in 203 mm
53-1417	4 mm	8 in 203 mm
53-1423	6 mm	8 in 203 mm
53-1420	5 mm	8 in 203 mm



Image Not Available



## Rongeurs (Lumbar)

### Kerrison Lumbar Rongeur

40° Up

CODE	DESCRIPTION	LENGTH
67-7267	2 mm	10 in 254 mm
67-7270	3 mm	10 in 254 mm
67-7273	4 mm	10 in 254 mm
67-7276	5 mm	10 in 254 mm

Image Not Available



### Kerrison Lumbar Rongeur

40° Up, Hardy Style Handle with Ball Spring

CODE	DESCRIPTION	LENGTH
53-1426	3 mm	11 in 279 mm
53-1427	4 mm	11 in 279 mm
53-1428	5 mm	11 in 279 mm
53-1429	6 mm	11 in 279 mm

Image Not Available



### Opti-Length Kerrison Lumbar Rongeur

40°

CODE	DESCRIPTION	LENGTH
67-7282	2 mm	12 in 305 mm
67-7285	3 mm	12 in 305 mm
67-7288	4 mm	12 in 305 mm

Image Not Available



### Opti-Length Kerrison Lumbar Rongeur

CODE	DESCRIPTION	LENGTH
67-7325	1 mm	15 in 380 mm
67-7326	2 mm	15 in 380 mm
67-7327	3 mm	15 in 380 mm
67-7328	4 mm	15 in 380 mm
67-7329	5 mm	15 in 380 mm
67-7330	1 mm	15 in 380 mm
67-7331	2 mm	15 in 380 mm
67-7332	3 mm	15 in 380 mm
67-7333	4 mm	15 in 380 mm
67-7334	5 mm	15 in 380 mm

Image Not Available



## Rongeurs (Lumbar)

### Kerrison Lumbar Rongeur

90° Down, Hardy Style Handle with Ball Spring

CODE	DESCRIPTION	LENGTH	
53-1416	3 mm	8 in	203 mm
53-1419	4 mm	8 in	203 mm
53-1422	5 mm	8 in	203 mm
53-1425	6 mm	8 in	203 mm

Image Not Available



### Kerrison Lumbar Rongeur

90° Up, Hardy Style Handle with Ball Spring

CODE	DESCRIPTION	LENGTH	
53-1415	3 mm	8 in	203 mm
53-1418	4 mm	8 in	203 mm
53-1421	5 mm	8 in	203 mm
53-1424	6 mm	8 in	203 mm

Image Not Available



### RapidClean Kerrison Detachable Lumbar Rongeur

40° Up

CODE	DESCRIPTION	LENGTH	
53-1612	2 mm	7 in	178 mm
53-1615	3 mm	7 in	178 mm
53-1618	4 mm	7 in	178 mm



53-1612LD

### RapidClean Kerrison Detachable Lumbar Rongeur

40° Up

CODE	DESCRIPTION	LENGTH	
53-1624LD	2 mm	8 in	203 mm
53-1627LED	3 mm	8 in	203 mm
53-1630LED	4 mm	8 in	203 mm
53-1633LED	5 mm	8 in	203 mm
53-1636LED	6 mm	8 in	203 mm

Image Not Available



## Rongeurs (Lumbar)

### RapidClean Kerrison Detachable Lumbar Rongeur

40° Up

CODE	DESCRIPTION	LENGTH
53-1642LD	2 mm	9 in 229 mm
53-1645LED	3 mm	9 in 229 mm
53-1648LED	4 mm	9 in 229 mm
53-1651LED	5 mm	9 in 229 mm
53-1654LED	6 mm	9 in 229 mm



53-1645LED

### RapidClean Opti-Length Kerrison Detachable Lumbar Rongeur

40° Up Bite with Ejector

CODE	DESCRIPTION	LENGTH
677297LED	2 mm	10 in 254 mm
677298LED	2 mm	11 in 280 mm
677299LED	3 mm	10 in 254 mm
677300LED	3 mm	11 in 280 mm
677304LED	2 mm	12 in 305 mm
677305LED	3 mm	12 in 305 mm



## Rongeurs (Micro)

### Micro Rongeur

40° Up, Bayonet

CODE	DESCRIPTION	LENGTH
46-2601	1 mm	2 3/4 in 70 mm



## Rongeurs (Micro Kerrison)

### Kerrison Rongeur

70° Up, Curved

CODE	DESCRIPTION	LENGTH
57-1100	2 mm	8 in 200 mm
57-1102	3 mm	8 in 200 mm
57-1104	4 mm	8 in 200 mm
57-1105	5 mm	8 in 200 mm



57-1105

### Micro Kerrison Rongeur

40° Up, Thin Footplate, 9 mm Opening

CODE	DESCRIPTION	LENGTH
57-0701	1 mm	7 in 175 mm
57-0702	2 mm	7 in 175 mm
57-0703	3 mm	7 in 175 mm
57-0704	4 mm	7 in 175 mm
57-0705	5 mm	7 in 175 mm



### Micro Kerrison Bayonet Rongeur

40° Up, Ceramic

CODE	DESCRIPTION	LENGTH
56-1001-BD	1 mm	6 ¼ in 160 mm
56-1002-BD	2 mm	6 ¼ in 160 mm
56-1003-BD	3 mm	6 ¼ in 160 mm
56-1004-BD	4 mm	6 ¼ in 160 mm
56-1005-BD	5 mm	6 ¼ in 160 mm



### Micro Kerrison Bayonet Rongeur

90° Up, Ceramic

CODE	DESCRIPTION	LENGTH
56-1201-BD	1 mm	6 ¼ in 160 mm
56-1202-BD	2 mm	6 ¼ in 160 mm
56-1203-BD	3 mm	6 ¼ in 160 mm
56-1204-BD	4 mm	6 ¼ in 160 mm
56-1205-BD	5 mm	6 ¼ in 160 mm



## Rongeurs (Micro Kerrison)

### Micro Kerrison Rongeur

40° Up, Small Handle, 15 mm Opening

CODE	DESCRIPTION	LENGTH
57-0022	2 mm	8 in 200 mm
57-0023	3 mm	8 in 200 mm
57-0024	4 mm	8 in 200 mm
57-0025	5 mm	8 in 200 mm



57-0022

### Micro Kerrison Rongeur

40° Up, Thin Footplate, 9 mm Opening

CODE	DESCRIPTION	LENGTH
57-0761	1 mm	8 in 200 mm
57-0761.5	1.5 mm	8 in 200 mm
57-0762	2 mm	8 in 200 mm
57-0763	3 mm	8 in 200 mm
57-0764	4 mm	8 in 200 mm
57-0765	5 mm	8 in 200 mm
57-0766	6 mm	8 in 200 mm



57-0761

### Micro Kerrison Rongeur

40° Up, Thin Footplate, 15 mm Opening

CODE	DESCRIPTION	LENGTH
57-0762.15	2 mm	8 in 200 mm
57-0763.15	3 mm	8 in 200 mm
57-0764.15	4 mm	8 in 200 mm
57-0765.15	5 mm	8 in 200 mm



57-0762.15

### Micro Kerrison Rongeur

40° Up, Thin Footplate, 9 mm Opening

CODE	DESCRIPTION	LENGTH
57-0891	1 mm	9 in 230 mm
57-0892	2 mm	9 in 230 mm
57-0893	3 mm	9 in 230 mm
57-0894	4 mm	9 in 230 mm
57-0895	5 mm	9 in 230 mm
57-0896	6 mm	9 in 230 mm

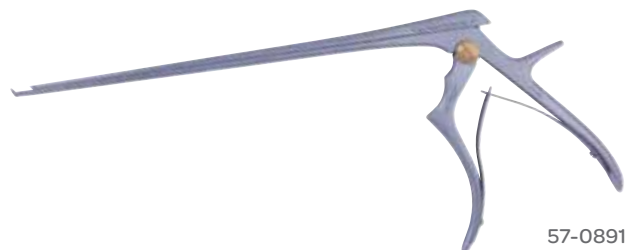

57-0891

## Rongeurs (Micro Kerrison)

### Micro Kerrison Rongeur

40° Up, Thin Footplate, 9 mm Opening

CODE	DESCRIPTION	LENGTH	
57-0101	1 mm	10 in	250 mm
57-0102	2 mm	10 in	250 mm
57-0103	3 mm	10 in	250 mm
57-0104	4 mm	10 in	250 mm
57-0105	5 mm	10 in	250 mm

Image Not Available



### Micro Kerrison Rongeur

40° Up, Thin Footplate, 9 mm Opening

CODE	DESCRIPTION	LENGTH	
57-0991	1 mm	11 in	280 mm
57-0992	2 mm	11 in	280 mm
57-0993	3 mm	11 in	280 mm
57-0994	4 mm	11 in	280 mm
57-0995	5 mm	11 in	280 mm
57-0996	6 mm	11 in	280 mm



57-0992

### Micro Kerrison Rongeur

40° Up, Thin Footplate, 9 mm Opening

CODE	DESCRIPTION	LENGTH	
57-0113	2 mm	12 in	305 mm
57-0113	3 mm	12 in	305 mm
57-0113	4 mm	12 in	305 mm
57-0115	5 mm	12 in	305 mm

Image Not Available



### Micro Kerrison Rongeur

90° Down

CODE	DESCRIPTION	LENGTH	
57-0751	1 mm	8 in	200 mm
57-0750	2 mm	8 in	200 mm
57-0753	3 mm	8 in	200 mm
57-0754	4 mm	8 in	200 mm
57-0755	5 mm	8 in	200 mm
57-0756	6 mm	8 in	200 mm



57-0750

## Rongeurs (Micro Kerrison)

### Micro Kerrison Rongeur

90° Up, Thin Footplate, 9 mm Opening

CODE	DESCRIPTION	LENGTH
57-0901	1 mm	9 in 230 mm
57-0902	2 mm	9 in 230 mm
57-0903	3 mm	9 in 230 mm
57-0904	4 mm	9 in 230 mm
57-0905	5 mm	9 in 230 mm



57-0901

### Micro Kerrison Rongeur

90° Up, Thin Footplate, 9 mm Opening

CODE	DESCRIPTION	LENGTH
57-0739	1 mm	8 in 200 mm
57-0740	2 mm	8 in 200 mm
57-0743	3 mm	8 in 200 mm
57-0744	4 mm	8 in 200 mm
57-0745	5 mm	8 in 200 mm
57-0746	6 mm	8 in 200 mm



57-0739

### Micro Kerrison Rongeur

90° Up, Thin Footplate, 9 mm Opening

CODE	DESCRIPTION	LENGTH
57-0911	1 mm	10 in 250 mm
57-0912	2 mm	10 in 250 mm
57-0913	3 mm	10 in 250 mm
57-0914	4 mm	10 in 250 mm
57-0915	5 mm	10 in 250 mm



57-0912

## Rongeurs (Pituitary)

### Pituitary Rongeur

Bayonet, Ceramic

CODE	DESCRIPTION	LENGTH
56-2112-BD	Straight, 2 x 8 mm	6 ¼ in 160 mm
56-2114-BD	Straight, 2 x 10 mm	6 ¼ in 160 mm
56-2116-BD	Angled, 2 x 8 mm	6 ¼ in 160 mm



56-2116-BD

## Rongeurs (Shaver)

### Opti-Length Microsect Shaver Rongeur

45°, Up Bite

CODE	TIP SIZE	LENGTH
67-7309	1.5 mm	10 in 254 mm
67-7310	2 mm	10 in 254 mm
67-7311	2.5 mm	10 in 254 mm
67-7312	3 mm	10 in 254 mm
67-7313	4 mm	10 in 254 mm
67-7314	1.5 mm	12 in 305 mm
67-7315	2 mm	12 in 305 mm
67-7316	2.5 mm	12 in 305 mm
67-7317	3 mm	12 in 305 mm
67-7318	4 mm	12 in 305 mm

Image Not Available



## Rongeurs (Spurling)

### Spurling Rongeur

Angled Down

CODE	DESCRIPTION	LENGTH
57-2274	4 x 10 mm Jaws	6 in 150 mm
57-2275	4 x 10 mm Jaws	9 in 230 mm

Image Not Available





## Rongeurs (Spurling)

### Spurling Rongeur

Angled Up

CODE	DESCRIPTION	LENGTH
57-2244	4 x 10 mm Jaws	6 in 150 mm
57-2273	4 x 10 mm Jaws	9 in 230 mm
57-2293	4 x 10 mm Jaws	11 in 280 mm

Image Not Available



### Spurling Rongeur

Straight

CODE	JAWS	LENGTH
57-2204	4 x 10 mm	5 in 125 mm
57-2214	4 x 10 mm	6 in 150 mm
57-2224	4 x 10 mm	7 in 175 mm
57-2270	4 x 10 mm	9 in 230 mm
57-2297	4 x 10 mm	12 in 300 mm

Image Not Available



## Rongeurs (Spurling Kerrison)

### Micro Kerrison Rongeur

40° Up, Thin Footplate

CODE	DESCRIPTION	LENGTH
57-0602	2 mm	6 in 150 mm
57-0603	3 mm	6 in 150 mm
57-0604	4 mm	6 in 150 mm
57-0605	5 mm	6 in 150 mm



57-0602

## Rongeurs (Spurling Kerrison)

### Spurling-Kerrison Rongeur

40° Up, with Ultra Coat, 15 mm Opening

CODE	DESCRIPTION	LENGTH	
57-0582UC	2 mm	8 in	200 mm
57-0583UC	3 mm	8 in	200 mm
57-0584UC	4 mm	8 in	200 mm
57-0585UC	5 mm	8 in	200 mm

Image Not Available



### Spurling-Kerrison Rongeur

40° Up, 15 mm Opening

CODE	DESCRIPTION	LENGTH	
57-0582	2 mm	8 in	200 mm
57-0583	3 mm	8 in	200 mm
57-0584	4 mm	8 in	200 mm
57-0585	5 mm	8 in	200 mm
57-0586	6 mm	8 in	200 mm

Image Not Available



### Spurling-Kerrison Rongeur

40° Up, 15 mm Opening

CODE	DESCRIPTION	LENGTH	
57-0782	2 mm	9 in	230 mm
57-0783	3 mm	9 in	230 mm
57-0784	4 mm	9 in	230 mm
57-0785	5 mm	9 in	230 mm
57-0786	6 mm	9 in	230 mm

Image Not Available



### Spurling-Kerrison Rongeur

40° Up, 15 mm Opening

CODE	DESCRIPTION	LENGTH	
57-0882	2 mm	10 in	250 mm
57-0883	3 mm	10 in	250 mm
57-0884	4 mm	10 in	250 mm
57-0885	5 mm	10 in	250 mm
57-0886	6 mm	10 in	250 mm

Image Not Available



## Rongeurs (Synovectomy)

### Kleinert Kutz Synovectomy Rongeur

2 mm Jaws

CODE	DESCRIPTION	LENGTH
30-7613	Slightly Curved	5½ in 140 mm
30-7614	Fully Curved	5½ in 140 mm



30-7614

### Synovectomy Forceps with Rongeur

2 mm Jaw

CODE	DESCRIPTION	LENGTH
30-7617	Ring Handle	5 in 125 mm

Image Not Available



## Rongeurs (Spurling Kerrison)

### Spurling-Kerrison Rongeur

40° Up, 15 mm Opening

CODE	DESCRIPTION	LENGTH
57-0592	2 mm	11 in 280 mm
57-0593	3 mm	11 in 280 mm
57-0594	4 mm	11 in 280 mm
57-0595	5 mm	11 in 280 mm

Image Not Available



### Spurling-Kerrison Rongeur

90° Up, 15 mm Opening

CODE	DESCRIPTION	LENGTH
57-0562	2 mm	8 in 200 mm
57-0563	3 mm	8 in 200 mm
57-0564	4 mm	8 in 200 mm
57-0565	5 mm	8 in 200 mm

Image Not Available



## Rongeurs (Spurling Kerrison)

### Spurling-Kerrison Rongeur

90° Down, 15 mm Opening

CODE	DESCRIPTION	LENGTH	
57-0572	2 mm	8 in	200 mm
57-0573	3 mm	8 in	200 mm
57-0574	4 mm	8 in	200 mm
57-0575	5 mm	8 in	200 mm

Image Not Available



## Rongeurs (Stille-Luer)

### Stille-Luer Rongeur

CODE	DESCRIPTION	JAW	LENGTH	
53-1130	Straight	10 mm	8 ½ in	216 mm
53-1131	Curved	10 mm	8 ½ in	216 mm
31-3183	Duckbill Angled	7 mm	9 in	230 mm
31-3193	Angled	5 mm	9 in	230 mm
53-1118	Angular, Flat Lower Jaw	5 mm	9 ½ in	241 mm
53-1133	Angular	5 mm	9 ½ in	241 mm
67-7239	Angled Jaw	5 mm	11 in	280mm
67-7241	Angled Jaw	5 mm	13 in	330mm
67-7240	Straight Jaw	10 mm	11 in	280mm
67-7242	Straight Jaw	10 mm	13 in	330mm



53-1130

## Rongeurs (Ultra Coat)

### Micro Kerrison Rongeur

40° Up, with Ultra Coat

CODE	DESCRIPTION	LENGTH	
57-0761UC	1 mm	8 in	200 mm
57-0762UC	2 mm	8 in	200 mm
57-0763UC	3 mm	8 in	200 mm
57-0764UC	4 mm	8 in	200 mm
57-0765UC	5 mm	8 in	200 mm

Image Not Available



### Micro Kerrison Rongeur

40° Up, with Ultra Coat

CODE	DESCRIPTION	LENGTH	
57-0891UC	1 mm	9 in	230 mm
57-0892UC	2 mm	9 in	230 mm
57-0893UC	3 mm	9 in	230 mm
57-0894UC	4 mm	9 in	230 mm
57-0895UC	5 mm	9 in	230 mm

Image Not Available



### Micro Kerrison Rongeur

40° Up, Thin Footplate, with Ultra Coat, 9 mm Opening

CODE	DESCRIPTION	LENGTH	
57-0991UC	1 mm	11 in	280 mm
57-0992UC	2 mm	11 in	280 mm
57-0993UC	3 mm	11 in	280 mm
57-0994UC	4 mm	11 in	280 mm
57-0995UC	5 mm	11 in	280 mm



57-0992UC

### Micro Kerrison Rongeur

40° Up, Small Handle, 15 mm Opening

CODE	DESCRIPTION	LENGTH	
57-0022UC	2 mm	8 in	200 mm
57-0023UC	3 mm	8 in	200 mm
57-0024UC	4 mm	8 in	200 mm
57-0025UC	5 mm	8 in	200 mm

Image Not Available



## Screws (Distraction)

### Distraction Screw

5/Per Box, Sterile

CODE	DESCRIPTION	LENGTH
57-5106T	12 mm	
57-5107T	14 mm	
57-5108T	16 mm	



## Shavers (Shaver)

### Microsect Shaver Rongeur

45° Up

CODE	DESCRIPTION	LENGTH
47-5030	1.5 mm	8 ½ in 216 mm
47-5030	2 mm	8 ½ in 216 mm
47-5032	2.5 mm	8 ½ in 216 mm
47-5033	3 mm	8 ½ in 216 mm
47-5034	4 mm	8 ½ in 216 mm



### Microsect Shaver Rongeur

45° Up

CODE	DESCRIPTION	LENGTH
67-7309	1.5 mm	10 in 254mm
67-7310	2 mm	10 in 254mm
67-7311	2.5 mm	10 in 254mm
67-7312	3 mm	10 in 254mm
67-7313	4 mm	10 in 254mm



### Microsect Shaver Rongeur

45° Up

CODE	DESCRIPTION	LENGTH
67-7314	1.5 mm	12 in 305 mm
67-7315	2 mm	12 in 305 mm
67-7316	2.5 mm	12 in 305 mm
67-7317	3 mm	12 in 305 mm
67-7318	4 mm	12 in 305 mm



SPINE

## Spreaders

### Cloward Style Vertical Spreader

CODE	DESCRIPTION	LENGTH
57-5583	65 mm	5 $\frac{7}{8}$ in
57-5584	75 mm	6 $\frac{1}{4}$ in
57-5585	85 mm	6 $\frac{1}{4}$ in



57-5583

## Spreaders (Lamina)

### Cloward Style Lamina Spreader

With Ratchet

CODE	DESCRIPTION
57-5581	Teeth on Tips



57-5581

### Inge Lamina Spreader

Child

CODE	TOTAL JAW OPENING	LENGTH
57-5505		6 $\frac{1}{4}$ in 159 mm
61-2516	$\frac{1}{4}$ in 32 mm	6 $\frac{1}{4}$ in 159 mm



61-2516

### Inge Lamina Spreader

CODE	DESCRIPTION	LENGTH
57-5503	Straight Body, Without Teeth	9 $\frac{1}{2}$ in 241 mm
57-5504	With Teeth	9 $\frac{1}{2}$ in 241 mm
57-5507	Without Teeth	9 $\frac{1}{2}$ in 241 mm
57-5509	Without Teeth	9 $\frac{1}{2}$ in 241 mm
57-5510	Without Teeth	9 $\frac{1}{2}$ in 241 mm
61-2515	Adult, Total Jaw Opening 2 $\frac{1}{2}$ in (64 mm)	10 in 250 mm
57-5506	Adult	10 in 250 mm
57-5503C	Curved Body	10 $\frac{3}{4}$ in 273 mm



57-5506

## Spreaders (Lamina)

### Lamina Spreader

CODE	DESCRIPTION	LENGTH
61-2525	Total Jaw Opening 2 in (51 mm)	9½ in 241 mm



## Spreaders (Vertebral)

### Vertebra Spreader

CODE	DESCRIPTION	LENGTH
61-1004	#1, with Ratchet, Total Opening ¾ in (19 mm)	5 in 127 mm
61-1005	#2, with Ratchet, Total Opening 1½ in (38 mm)	3 in 76 mm



61-1004

## Sterilizing Case Containers

### RapidClean Sterilization Tray

CODE
53-1660

Image Not Available





## Suction Tubes

### Fukushima

Tapered Teardrop, Thumb Control

CODE	DESCRIPTION	LENGTH	
67-7868	4 French	9 in	228 mm
67-7869	5 French	9 in	228 mm
67-7870	6 French	9 in	228 mm
67-7871	7 French	9 in	228 mm
67-7872	8 French	9 in	228 mm
67-7873	9 French	9 in	228 mm



### Tear-Drop Suction Tube

Tapered Tube, Malleable Stainless Steel

CODE	DESCRIPTION	LENGTH	
57-4076	6 French	7 in	175 mm
57-4077	7 French	7 in	175 mm
57-4078	8 French	7 in	175 mm
57-4079	9 French	7 in	175 mm
57-4080	10 French	7 in	175 mm
57-4082	12 French	7 in	175 mm
57-4085	5 French	8 in	200 mm

Image Not Available

### Wire Stylets

CODE	DESCRIPTION	LENGTH
46-4000	Used with Dural Suction Retractors for Cleaning and Storage.	

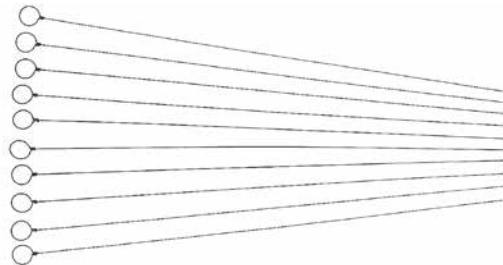

## Suction Tubes (Dural)

### 90° Dural Suction Retractor

Standard Macro, Black

CODE	DESCRIPTION	TIP WIDTH	TIP DEPTH	LENGTH
46-3013		$\frac{3}{8}$ in 9.5 mm	$\frac{1}{4}$ in 6 mm	$4\frac{3}{4} \times 4\frac{1}{2}$ in 12 x 114 mm



### Dural Suction Retractor (Extended Macro)

90°, Black

CODE	WORKING DISTANCE	LENGTH
46-3015	$5\frac{3}{4}$ in 146 mm	$\frac{3}{8} \times \frac{1}{4} \times 4\frac{5}{8}$ in 9.5 x 6 x 117 mm
46-3014	$5\frac{3}{4}$ in 146 mm	$\frac{1}{4} \times \frac{1}{4} \times 4\frac{5}{8}$ in 6 x 6 x 117 mm



46-3015

## Suction Tubes (Holder)

### Crockard Suction Tube Holder

Diameter  $\frac{3}{16}$  in (7 mm)

CODE	DESCRIPTION	LENGTH	
50-1657	Short	1½ in	38 mm
50-1658	Long	2 in	51 mm



50-1657



50-1658

## Tamps

### Sypert Tamp

CODE	DESCRIPTION	LENGTH	
27-9534	4 x 10 mm	11½ in	290 mm
27-9535	5 x 15 mm	11½ in	290 mm
27-9536	6 x 20 mm	11½ in	290 mm



27-9534

## Tamps (ACF)

### Ultra ACF Bone Tamp

CODE	DESCRIPTION	LENGTH
59-0121	3 mm	
59-0122	5 mm	
59-0123	8 mm	



59-0121

## Tamps (Bone)

### Bone Tamp

CODE	DESCRIPTION	LENGTH
27-9502	2 mm	6 in 150 mm
27-9503	3 mm	6 in 150 mm
27-9504	4 mm	6 in 150 mm
27-9505	5 mm	6 in 150 mm
27-9506	6 mm	6 in 150 mm
27-9507	7 mm	6 in 150 mm
27-9510	10 mm	6 in 150 mm

Image Not Available



### Caspar Bone Tamp

CODE	DESCRIPTION	LENGTH
27-9601	3 mm	8 in 200 mm
27-9602	5 mm	8 in 200 mm
27-9603	8 mm	8 in 200 mm
27-9516	5 mm	8 in 200 mm
27-9520	12 mm	8 in 200 mm



27-9601

## Spine (Pliers)

### Pin Pulling Pliers

CODE	DESCRIPTION	LENGTH
32-048	3 mm Tip, Tungsten Carbide Jaws	5½ in 140 mm

Image Not Available



### Wire Extraction Pliers

CODE	DESCRIPTION	LENGTH
32-113	6 mm Jaw, Tungsten Carbide Jaws	7 in 178 mm

Image Not Available



## Trephines

### Galt Trephines

CODE	DESCRIPTION
57-6313	½ in 12 mm



### Michele Trephine

CODE	DESCRIPTION
57-6305	6 ¼ in Shaft Graduated ¼ in - 1 ¼ in (5 mm)

Image Not Available



### Flush Wire Cable Cutter

CODE	DESCRIPTION	LENGTH
32-129	Tungsten Carbide Jaws	7 in 178 mm



## Wire and Pin Cutters

### Kirschner Wire Cutter

CODE	DESCRIPTION	LENGTH
56-2507	Chrome Plated	11¼ in 159 mm



### Side Cutting Forceps

Double Action

CODE	DESCRIPTION	LENGTH
32-3371	Straight Jaw	9 in 229 mm
32-3372	Angled Jaw	6½ in 165 mm
32-3373	Angled Jaw	9 in 229 mm



32-3371

### Side Cutting Forceps

Max Capacity 1.6 mm

CODE	DESCRIPTION	LENGTH
32-118	Tungsten Carbide Jaws	7 in 178 mm
32-119	Tungsten Carbide Jaws	8 in 200 mm



32-118

### Side Cutting Forceps

CODE	DESCRIPTION	LENGTH
32-125	Tungsten Carbide	6 in 150 mm



## Wire and Pin Cutters

### Wire Cutting Pliers

Tungsten Carbide Jaws

CODE	DESCRIPTION	LENGTH
32-127	Angled, Max Capacity 1.6 mm	7 in 178 mm
32-128	Side Cutting, Max Capacity $\frac{3}{32}$ in	8½ in 215 mm
32-117-H	Max Capacity 2.5 mm	9 in 230 mm



32-127

### Wire Cutting Pliers

Jaws Max Capacity  $\frac{1}{16}$  in (2 mm)

CODE	DESCRIPTION	LENGTH
32-102	Tungsten Carbide	7½ in 180 mm



### Wire Cutting Pliers

CODE	DESCRIPTION	LENGTH
56-2510	Stainless Steel	7 in 178 mm
32-3341	Tungsten Carbide Inserts	7 in 178 mm



56-2510

### Wire Cutting Pliers

CODE	LENGTH
32-126	4¾ in 120 mm

Image Not Available



## Wire and Pin Cutters

### Wire Cutting Scissors

CODE	DESCRIPTION	LENGTH
32-100	Tungsten Carbide	6¼ in 160 mm

Image Not Available



## Wire Twisters

### Rubio Wire Twister

Snub Nose

CODE	DESCRIPTION	LENGTH
32-302	Jaws have Tungsten Carbide Inserts	5¼ in 135 mm



### Ultra Wire Twister

CODE	DESCRIPTION	LENGTH
32-123	Jaws have Tungsten Carbide Inserts	6¾ in 171 mm



## Wrenches

### Spanner Wrench

CODE
80-1012

