

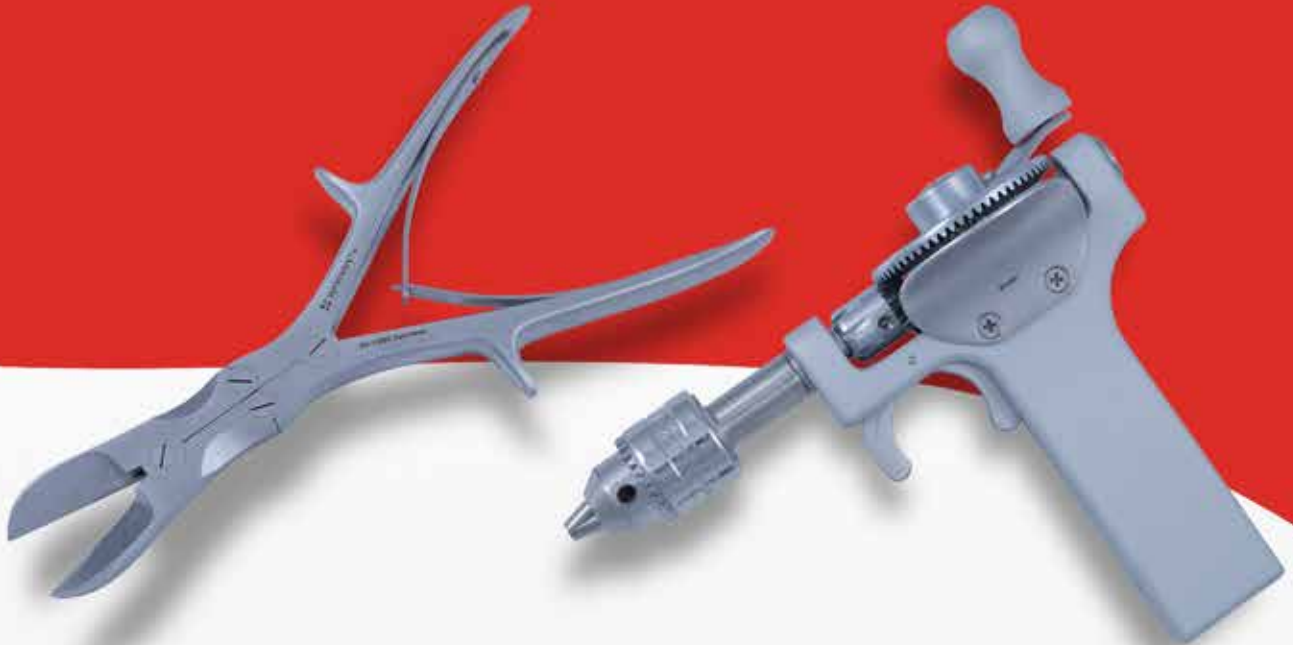

Scan the code above to
learn more about our
Neurology portfolio.



Neuro



Blades	NEU-2	Mallets	NEU-56	Skull Tongs	NEU-122
Calipers	NEU-2	Markers	NEU-67	Spatulas	NEU-123
Cannulas	NEU-2	Mirrors	NEU-57	Speculums	NEU-125
Clips	NEU-2	Needle Holders	NEU-57	Sponges	NEU-126
Containers	NEU-3	Needles	NEU-61	Spoons	NEU-126
Cords	NEU-6	Osteotomes	NEU-61	STA-MCA Kits	NEU-127
Curettes	NEU-6	Probes	NEU-62	Suction Tubes	NEU-128
Dissectors	NEU-11	Punches	NEU-63	Symmetry Micro Instrument Kit	NEU-133
Drills	NEU-17	Pushers	NEU-64	Test Instruments	NEU-134
Elevators	NEU-21	Rasps	NEU-64	Transsphenoidal Instruments	NEU-134
Enucleators	NEU-27	Retractors	NEU-64	Trephines	NEU-137
Forceps	NEU-28	Rongeurs	NEU-85		
Hooks	NEU-43	Saws	NEU-110		
Knife Handles	NEU-53	Scissors	NEU-113		
Knives	NEU-54	Scoops	NEU-121		
Ligature Instruments	NEU-56	Separators	NEU-121		

Blades (Temporary Clip)

Temporary Clip Blade

Slight Curve

CODE	DESCRIPTION	LENGTH
58-5078	9 mm, Opening	8 in 203 mm

Image Not Available



Calipers

Neuro Caliper

CODE	DESCRIPTION	LENGTH
57-6050	Caliper	9¼ in 235 mm

Image Not Available



Cannulas

Frazier Brain Cannula

CODE	DIAMETER	LENGTH
57-3902	2.0 mm	4 in 102 mm
57-3904	3.0 mm	4 in 102 mm

Image Not Available



Clips (Aneurysm)

Micro Aneurysm Clip

9.0 mm

CODE	DESCRIPTION
58-5009	Straight
58-5019	Angled
58-5029	Slight Curve
58-5039	Strong Curve



58-5019

Clips (Aneurysm)

Raney Clip Applier

CODE	DESCRIPTION
57-8505	Clip Applier



Containers (Micro Instruments)



80-1564

Microcare Bayonet Case

Removable Lid

CODE	DESCRIPTION	LENGTH	
80-1564	Small	10 ½ in	267 mm
80-1565	Large	15 in	381 mm

Containers (Micro Instruments)



Microcare Combo Instrument Case

Designed to hold both Straight and Bayonet Instruments

CODE	DESCRIPTION	LENGTH
80-1567	Combo Instrument Case	15 in 381 mm



Microcare Instrument Case

Designed to hold straight instruments

CODE	DESCRIPTION	WIDTH	DEPTH	LENGTH
80-1563	Instrument Case	10 in 254 mm	1¼ in 32 mm	10½ in 267 mm



Microcare Universal Bayonet Instrument Case

CODE	DESCRIPTION	WIDTH	DEPTH	LENGTH
80-1914	Instrument Case	13 in 330 mm	1½ in 38 mm	21 in 533 mm

Containers (Micro Instruments)

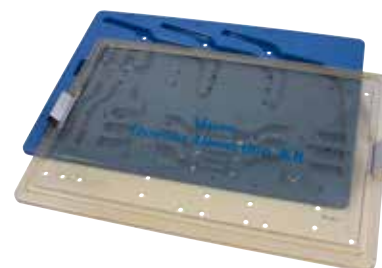

Osseous Dissection Instruments Sterilizing Case

CODE	DESCRIPTION
46-2613	Instruments Sterilizing Case



Rhoton Sterilizing Carrying Case

CODE	DESCRIPTION
80-1661	Sterilizing Carrying Case



Sterilizing O.R. Display Case

CODE	DESCRIPTION	DIMENSIONS
46-3003	Holds instrument set: 46-3002 (Instruments Sold Separately)	10 x 4 ½ in 254 x 107 mm



Hudson Sterilizing Case

CODE	DESCRIPTION
21-1002C	For use with instrument set: 26-1075

Containers



Hardy Instrument Case with Removable Panels

CODE	DESCRIPTION	WIDTH		DEPTH			
80-1355	Instrument Case	7 in	178 mm	2¼ in	57 mm	11 in	279 mm

Cords (Air Hoses)

Air Hose

CODE	DESCRIPTION	LENGTH	
26-5007	Air Hose	10 ft	3 m



Curettes (Cup)

Bruns Curette

Hexagonal Handle

CODE	SIZE	CUP SIZE	LENGTH	
32-3400	000	3.2 mm	9 in	229 mm
32-3401	00	3.4 mm	9 in	229 mm
32-3402	0	3.7 mm	9 in	229 mm
32-3403	1	4.7 mm	9 in	229 mm
32-3404	2	5.7 mm	9 in	229 mm
32-3405	3	7.0 mm	9 in	229 mm
32-3406	4	8.4 mm	9 in	229 mm
32-3407	5	8.9 mm	9 in	229 mm
32-3408	6	10.2 mm	9 in	229 mm

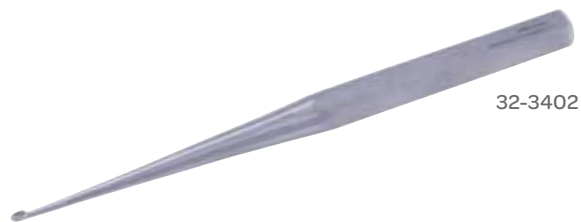

32-3402

Curettes (Cup)

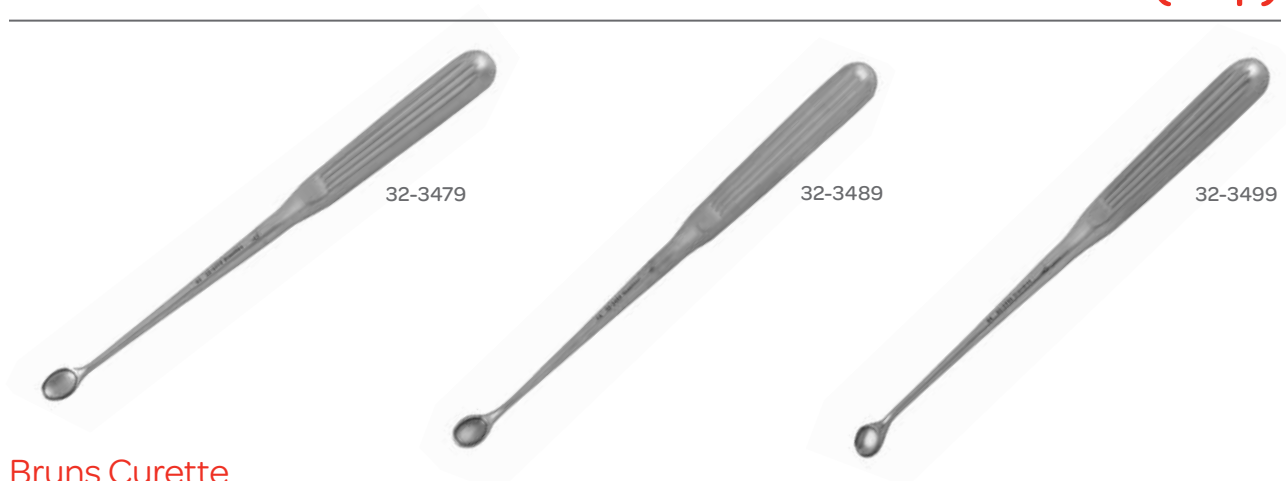

Bruns Curette

Hollow Handle

CODE	SIZE	ANGLE	CUP SIZE	LENGTH
32-3470	0000	Straight	3.0 mm	9 in 229 mm
32-3480	0000	Forward Angle	3.0 mm	9 in 229 mm
32-3490	0000	Reverse Angle	3.0 mm	9 in 229 mm
32-3471	000	Straight	3.2 mm	9 in 229 mm
32-3481	000	Forward Angle	3.3 mm	9 in 229 mm
32-3491	000	Reverse Angle	3.2 mm	9 in 229 mm
32-3472	00	Straight	3.4 mm	9 in 229 mm
32-3482	00	Forward Angle	3.9 mm	9 in 229 mm
32-3492	00	Reverse Angle	3.4 mm	9 in 229 mm
32-3473	0	Straight	3.7 mm	9 in 229 mm
32-3483	0	Forward Angle	4.5 mm	9 in 229 mm
32-3493	0	Reverse Angle	3.7 mm	9 in 229 mm
32-3474	1	Straight	4.7 mm	9 in 229 mm
32-3484	1	Forward Angle	5.3 mm	9 in 229 mm
32-3494	1	Reverse Angle	4.5 mm	9 in 229 mm
32-3475	2	Straight	5.7 mm	9 in 229 mm
32-3485	2	Forward Angle	6.0 mm	9 in 229 mm
32-3495	2	Reverse Angle	5.7 mm	9 in 229 mm
32-3476	3	Straight	7.0 mm	9 in 229 mm
32-3486	3	Forward Angle	7.2 mm	9 in 229 mm
32-3496	3	Reverse Angle	7.0 mm	9 in 229 mm
32-3477	4	Straight	8.4 mm	9 in 229 mm
32-3487	4	Forward Angle	8.2 mm	9 in 229 mm
32-3497	4	Reverse Angle	8.4 mm	9 in 229 mm
32-3478	5	Straight	8.9 mm	9 in 229 mm
32-3488	5	Forward Angle	9.8 mm	9 in 229 mm
32-3498	5	Reverse Angle	8.9 mm	9 in 229 mm
32-3479	6	Straight	10.2 mm	9 in 229 mm
32-3489	6	Forward Angle	12.5 mm	9 in 229 mm
32-3499	6	Reverse Angle	10.2 mm	9 in 229 mm

Curettes (Cup)

Epstein Curette

CODE	DESCRIPTION	LENGTH
57-4624	#00	10 in 254 mm



Karlin Cervical Curette

Working Distance 4.1 in (104 mm), Handle Width 0.6 in (15 mm)

CODE	SIZE/DESCRIPTION	ANGLE	LENGTH
46-2629	XL 0000	Forward Straight	9½ in 241 mm
46-2639	XL 0000	Backward Straight	9½ in 241 mm
46-2634	XL 0000	Forward Angle	9½ in 241 mm
46-2644	XL 0000	Backward Angle	9½ in 241 mm
46-2628	XL 000	Forward Straight	9½ in 241 mm
46-2638	XL 000	Backward Straight	9½ in 241 mm
46-2633	XL 000	Forward Angle	9½ in 241 mm
46-2643	XL 000	Backward Angle	9½ in 241 mm
46-2627	XL 00	Forward Straight	9½ in 241 mm
46-2637	XL 00	Backward Straight	9½ in 241 mm
46-2632	XL 00	Forward Angle	9½ in 241 mm
46-2642	XL 00	Backward Angle	9½ in 241 mm
46-2626	XL 0	Forward Straight	9½ in 241 mm
46-2636	XL 0	Backward Straight	9½ in 241 mm
46-2631	XL 0	Forward Angle	9½ in 241 mm
46-2641	XL 0	Backward Angle	9½ in 241 mm



46-2626

Curettes (Hyphosectomy)

Caspar Curette

Square Handle

CODE	DESCRIPTION	TIP SIZE	LENGTH
32-3410	Reverse	4.0 mm	9¾ in 248 mm
32-3411	Reverse	5.0 mm	9¾ in 248 mm



32-3410

Curettes (Micro)

Micro Curette

Bayonet, Working Distance 3 in (76 mm)

CODE	SIZE	ANGLE
46-2606	0000	Straight
46-2609	0000	45° Up
46-2612	0000	80° Down
46-2605	000	Straight
46-2608	000	45° Up
46-2611	000	80° Down
46-2607	00	45° Up
46-2610	00	80° Down



46-2607

Yasargil Micro Curette

CODE	DESCRIPTION	LENGTH
58-3309	Oval Cup	7¼ in 184 mm

Image Not Available



Curettes (Micro Pituitary)

Nicola Micro Pituitary Curette

Malleable, 6.5 mm Ring

CODE	DESCRIPTION	LENGTH
58-3550	Straight	8¼ in 210 mm
58-3548	Left-Cutting	8¼ in 210 mm



58-3548

Curettes (Pituitary)

Fahlbusch Pituitary Curette

CODE	CUP	LENGTH
58-3627	2.5 mm	10¼ in 260 mm



Curettes (Pituitary)

Ray Pituitary Curette

CODE	ANGLE	WIDTH	LENGTH
57-4803	45°	3.0 mm	7½ in 191 mm
57-4805	45°	5.0 mm	7½ in 191 mm
57-4823	45° Angled to Side	3.0 mm	7½ in 191 mm
57-4825	45° Angled to Side	5.0 mm	7½ in 191 mm
57-4813	90°	3.0 mm	7½ in 191 mm
57-4815	90°	5.0 mm	7½ in 191 mm
57-4833	90° Angled to Side	3.0 mm	7½ in 191 mm
57-4835	90° Angled to Side	5.0 mm	7½ in 191 mm

Image Not Available



Curettes (Ring)

Cone Ring Curette

Straight

CODE	SIZE	RING I.D.	LENGTH
23-1013	#1	5/16 in 8.0 mm	9 in 229 mm
23-1014	#2	¼ in 6.0 mm	9 in 229 mm
23-1015	#3	⅛ in 3.0 mm	9 in 229 mm



23-1014

Curettes (Transsphenoidal)

Hardy Curette

Bayonet

Image Not Available



CODE	DESCRIPTION	TIP WIDTH	WORKING DISTANCE	LENGTH
80-1347	45° Right	3.0 mm	4¾ in 121 mm	9¼ in 235 mm
80-1334	45° Right	5.0 mm	4¾ in 121 mm	9¼ in 235 mm
80-1348	90° Left	3.0 mm	4¾ in 121 mm	9¼ in 235 mm
80-1333	90° Left	5.0 mm	4¾ in 121 mm	9¼ in 235 mm
80-1345	Angled Down	3.0 mm	4¾ in 121 mm	9¼ in 235 mm
80-1330	Angled Down	5.0 mm	4¾ in 121 mm	9¼ in 235 mm
80-1346	Angled Up	3.0 mm	4¾ in 121 mm	9¼ in 235 mm
80-1331	Angled Up	5.0 mm	4¾ in 121 mm	9¼ in 235 mm
80-1335	Curved Left	3.0 mm	4¾ in 121 mm	9¼ in 235 mm
80-1332	Curved Right	5.0 mm	4¾ in 121 mm	9¼ in 235 mm

Curettes

Malis Curette

Stainless Steel Shaft, Titanium Handle

CODE	DESCRIPTION	WORKING DISTANCE	LENGTH
80-1536	Bayonet	4 in (102 mm)	8 in 203 mm



Dissectors (Ball)

Rhoton Ball Dissector

CODE	DESCRIPTION	WIDTH	LENGTH
58-6072	45° Angle	4.0 mm	7½ in 191 mm

Image Not Available



Dissectors (Cherry)

Cherry Secto Dissector

Dispenser Includes: 96 Packages of 5 Each, Four Dispensers per Case

CODE	DESCRIPTION	DIAMETER
81-1002	Sterile, X-Ray Detectable	⅜ in 10 mm
81-1006	Triangle	½ in 13 mm

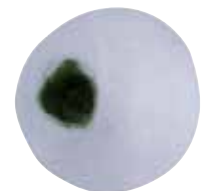

81-1002

Dissectors (Disc)

Disc Dissector

CODE	DESCRIPTION	LENGTH
80-2078	2.5 mm, Round	



Dissectors (Double-Ended)

Olivecrona Double-Ended Dissector

CODE	WIDTH	LENGTH
57-3601	2.0x3.0 mm	7 in 178 mm
57-3604	4.0x5.0 mm	9½ in 241 mm



57-3601

Dissectors (Dural)

Milligan Dissector

CODE	DESCRIPTION	TIP SIZE	LENGTH
65-1038	Double-Ended	14 mm and 16 mm	8½ in 216 mm



Dissectors (Kitner)

Kitner Secto Dissector

480 Per Kit

CODE	DESCRIPTION	DIAMETER
81-1001	Sterile, X-Ray Detectable	5/16 in 8 mm

Image Not Available



Dissectors (MagnaFree)

Penfield MagnaFree Dissector

CODE	DESCRIPTION	LENGTH
65-2402	#1, Broad Curved Dissector, and Sharp Round Spoon	7 in 178 mm
65-2403	#2, Slightly Curved Dissector, and Wax Packer	7¾ in 197 mm
65-2404	#3, Fully Curved Dissector, and Wax Packer	7¾ in 197 mm
65-2405	#4, Slightly Curved Dissector, Light Length	8¼ in 210 mm

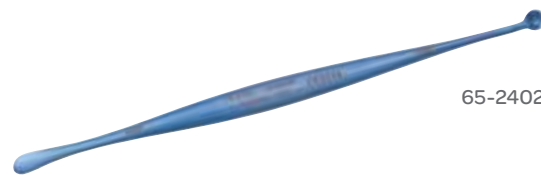

65-2402

Dissectors (Micro)

Caspar Micro Dissector

CODE	DESCRIPTION	BLADE	LENGTH	
58-3323	Curved Up, Bayonet Shaft	1.0 mm	8¼ in	210 mm
58-3325	Curved Down, Bayonet Shaft	2.0 mm	9 in	229 mm
58-3327	Curved Down, Straight Shaft	4.5 mm	9 in	229 mm



Yasargil Micro Dissector

CODE	DESCRIPTION	LENGTH
58-3015	Angled, Pointed Blade, 2.5 mm Wide	7¼ in 184 mm



Dissectors (Neck)

Jannetta Neck Dissector

CODE	DESCRIPTION	LENGTH
58-6214	Angled 30°, Right	7½ in 191 mm

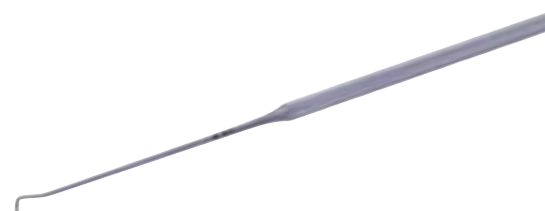

Dissectors (Neck Hook)

Smithwick Neck Hook Dissector

CODE	DESCRIPTION	HOOK LENGTH	LENGTH	
38-1088	Double-Ended, Blunt	⅞ in 11 mm	12 in	305 mm

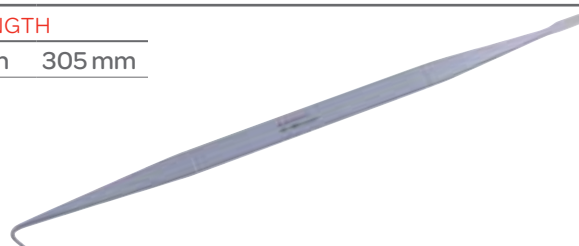

Dissectors (Neurovascular)

Spetzler Neurovascular Dissector

Titanium, Bayonet

CODE	DESCRIPTION	WORKING DISTANCE	LENGTH
80-1900	30° Angled Up, Small Teardrop	4 in 102 mm	9½ in 241 mm
80-1902	30° Angled Up, Small Spatula	4 in 102 mm	9½ in 241 mm
80-1901	90° Angled Up, Small Teardrop	4 in 102 mm	9½ in 241 mm

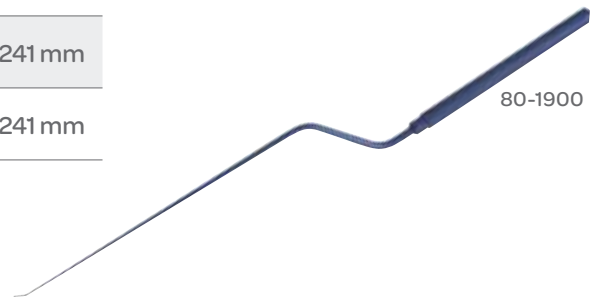

Dissectors (Peanut)

Peanut Secto Dissector

Dispenser Includes: 96 Packages of 5 Each, Four Dispensers per Case

CODE	DESCRIPTION	DIAMETER	LENGTH
81-1000	X-Ray Detectable	⅜ in 10 mm	8¾ in 222 mm

Image Not Available



Dissectors (Teardrop)

Apfelbaum Tear Drop Dissector

CODE	ANGLE	LENGTH
58-6260	45°	8¾ in 222 mm



Dissectors (Transsphenoidal)

Hardy Micro Dissector

Bayonet

CODE	DESCRIPTION	WORKING DISTANCE	LENGTH
80-1316	Angled Down	4 ³ / ₄ in 121 mm	9 ¹ / ₄ in 235 mm
80-1315	Angled Up	4 ³ / ₄ in 121 mm	9 ¹ / ₄ in 235 mm



80-1316

Dissectors (Triangle)

Triangle Secto Dissector

Dispenser Includes: 96 Packages of 5 Each, Four Dispensers per Case, 480 per Box, Sterile

CODE	DESCRIPTION	DIAMETER
81-1006	X-Ray Detectable	¹ / ₂ in 13 mm



Dissectors

Jannetta Dissector

CODE	DESCRIPTION	LENGTH
58-6205	Curved Small	7 ¹ / ₂ in 191 mm

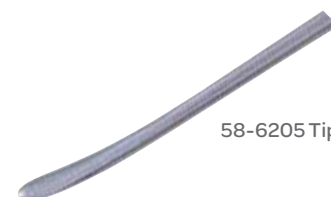

58-6205 Tip

Malis Dissector

Angled, Stainless Steel Handle, Titanium Handle

CODE	DESCRIPTION	TIP WIDTH	LENGTH
80-1535	Curved Edge, Semi-Sharp	3.2 mm	7 ³ / ₈ in 187 mm
80-1539	Sharp on Three Sides	1.3 mm	7 ³ / ₈ in 187 mm
80-1541	Round	1.0 mm	7 ³ / ₈ in 187 mm
80-1540	Round	2.0 mm	7 ³ / ₈ in 187 mm
80-1542	Round	3.5 mm	7 ³ / ₈ in 187 mm



80-1535

Dissectors

Penfield Dissector

CODE	SIZE	DESCRIPTION	LENGTH	
65-1015	#1	Broad Curved Dissector and Sharp Round Spoon	7 in	178 mm
57-3651	#1	Broad Curved Dissector and Sharp Round Spoon	7 1/8 in	181 mm
65-1016	#2	Slightly Curved Dissector and Wax Packer	7 3/4 in	197 mm
57-3652	#2	Slightly Curved Dissector and Wax Packer	8 in	203 mm
65-1017	#3	Fully Curved Dissector and Wax Packer	7 3/4 in	197 mm
57-3653	#3	Fully Curved Dissector and Wax Packer	8 in	203 mm
57-3654	#4	Single-Ended, Round Handle	8 1/2 in	216 mm
65-1018	#4	Slightly Curved Dissector, Light	8 1/4 in	210 mm
65-1019	#5	Double-Ended	11 1/2 in	292 mm



57-3651



80-1660

Rhoton Micro Dissector Set

CODE	SIZE	DESCRIPTION	ETCHED LABEL	TIP WIDTH	LENGTH
80-1660	Contains 1 each of the following:				
80-1680	Rhoton Dissector	Small	#1	1.3 mm	7 1/2 in 191 mm
80-1681	Rhoton Dissector	Medium	#2	2.3 mm	7 1/2 in 191 mm
80-1682	Rhoton Dissector	Large	#3	3.3 mm	7 1/2 in 191 mm
80-1683	Rhoton General Purpose Elevator	Small	#4		7 1/2 in 191 mm
80-1684	Rhoton General Purpose Elevator	Large	#5		7 1/2 in 191 mm
80-1685	Rhoton Spatula Dissector	Small	#6	1.1 mm	7 1/2 in 191 mm
80-1686	Rhoton Spatula Dissector	Medium	#7	1.7 mm	7 1/2 in 191 mm
80-1687	Rhoton Spatula Dissector	Large	#8	2.1 mm	7 1/2 in 191 mm
80-1688	Rhoton Semi-Sharp Hook	90°	#9		7 1/2 in 191 mm
80-1689	Rhoton Blunt Hook	90°	#10		7 1/2 in 191 mm
80-1690	Rhoton Semi-Sharp Hook	40°	#11		7 1/2 in 191 mm
80-1691	Rhoton Needle Point, Sharp	Straight	#12		7 1/2 in 191 mm
80-1692	Rhoton Curette	Small	#13	1.6 mm	7 1/2 in 191 mm
80-1693	Rhoton Curette	Large	#14	1.4 mm	7 1/2 in 191 mm
80-1679	Rhoton Teardrop Dissector	Straight	#15	3.0 mm	7 1/2 in 191 mm
80-1696	Rhoton Teardrop Dissector	90°	#16	3.0 mm	7 1/2 in 191 mm
80-1697	Rhoton Teardrop Dissector	90°	#17	5.0 mm	7 1/2 in 191 mm
80-1698	Rhoton Teardrop Dissector	40°	#18	4.0 mm	7 1/2 in 191 mm
80-1699	Rhoton Teardrop Dissector	40°	#19	8.0 mm	7 1/2 in 191 mm
80-1661	Rhoton Set Instrument Case				

Dissectors

Rhoton Spatula Dissector

Straight, Titanium

CODE	DESCRIPTION	LENGTH
58-6020T	Small	7½ in 191 mm
58-6021T	Medium	7½ in 191 mm
58-6022T	Large	7½ in 191 mm



58-6020T

Drills (Burrs)

Cushing Burr

CODE	DIAMETER	LENGTH
15-1000C	⅜ in 10 mm	3½ in 89 mm



Drills (Burr Set)



26-1075

Hudson Cranial Drill Set

CODE	SIZE	DIAMETER	LENGTH
26-1075	Hudson Cranial Drill Set Consists of the Items Below:		
15-1005	Hudson Burr	⅜ in 10 mm	4 in 102 mm
15-1006	Hudson Burr	⅞ in 14 mm	4 in 102 mm
15-1007	Hudson Burr	⅝ in 16 mm	4 in 102 mm
15-1008	Hudson Burr	⅞ in 22 mm	4 in 102 mm
80-1002	Cerebellar Extension		
26-1041	Brace		
21-1002	Hudson Cranial Drill Set Case		

Drills (Cerebellar)

Hudson Cerebellar Extension

CODE	DESCRIPTION
80-1002	Cerebellar Extension



Drills (Cervical Tip)

Cervical Drill Tip

CODE	DESCRIPTION
26-1265	10 mm
26-1266	12 mm
26-1267	14 mm
26-1268	16 mm



26-1265

Drills (Cranial)

Hudson Cranial Drill

CODE	DESCRIPTION	LENGTH
57-6004	Brace Only, Standard Thumb Lock	10 1/2 in 267 mm
57-6000	Cranial Drill	

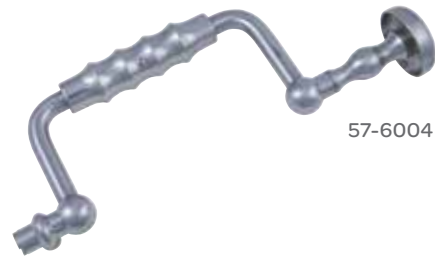

57-6004

Drills (Crossbar Handle)

Crossbar Handle

CODE	DESCRIPTION
11-1002	Crossbar Handle



Drills (Drill Point)

Mathews Drill Point

CODE	DIAMETER	LENGTH
26-1181	6.0 mm	1 $\frac{7}{8}$ in 48 mm

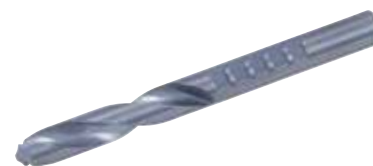

Drills (Enlarging Burr)

Mckenzie Enlarging Burr

CODE	DIAMETER	LENGTH
15-1004	1 $\frac{1}{16}$ in 27 mm	5 in 127 mm



Drills (Guard Cap)

Drill Guard Cap

CODE	DIAMETER	LENGTH
12-1007	1 in 25 mm	1 $\frac{1}{4}$ in 32 mm



Drills (Guide & Dura Protector)

Adson Drill Guide & Dura Protector

Angled on Side, With Hole in Jaw

CODE	JAW LENGTH	HOLE DIAMETER	LENGTH
14-1000	$\frac{3}{4}$ in 19 mm	$\frac{1}{8}$ in 3.0 mm	6 in 152 mm



Drills (Hand-Operated)

Bunnell Hand Drill

CODE	DESCRIPTION	LENGTH
26-1080	With Jacobs Chuck	$\frac{5}{32}$ in 4.0 mm



Drills (Perforator)

Cushing Perforator Drill

CODE	DIAMETER	LENGTH
26-1000	$\frac{3}{8}$ in 9.0 mm	4 in 102 mm
26-1001	$\frac{1}{2}$ in 13 mm	4 in 102 mm
26-1002	$\frac{5}{8}$ in 16 mm	4 in 102 mm



26-1000

D'Errico Perforator Drill & Enlarging Burr

CODE	DESCRIPTION	LENGTH
26-1006	Drill and Enlarging Burr	$3\frac{5}{8}$ in 92 mm



Mckenzie Perforator Drill

High Speed Steel

CODE	DIAMETER	LENGTH
26-1004	$\frac{1}{2}$ in 13 mm	4 in 102 mm



Drills (Perforator)

Raney Perforator Drill

With Adjustable Depth Guard

CODE	DIAMETER	LENGTH
26-1008	½ in 13 mm	4 in 102 mm



Drills (Shaft)

Drill Shaft

CODE	DESCRIPTION	LENGTH
28-1002	Large (16 mm)	5 9/16 in 141 mm
28-1001	Small (13 mm)	5 9/16 in 141 mm



Elevators (Angled)

Jannetta Angled Elevator

CODE	DESCRIPTION	LENGTH
58-6204	Angled Elevator	7 ½ in 191 mm

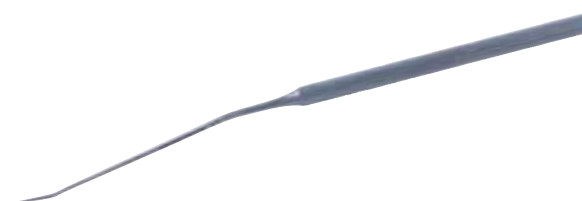

Elevators (Duckbill)

Jannetta Duckbill Elevator

CODE	DESCRIPTION	LENGTH
58-6203	Duckbill Elevator	7 ½ in 191 mm



Elevators (General Purpose)

Rhoton General Purpose Elevator

CODE	DESCRIPTION	LENGTH
80-1684	#5, Titanium, Large, Curved, Blunt	7½ in 191 mm
80-1683	#4, Titanium, Small, Straight, Blunt	7½ in 191 mm
58-6011	Angled Tip	7½ in 191 mm



80-1684

Elevators (MagnaFree)

Woodson MagnaFree Elevator & Spatula

Double-Ended, Semi-Sharp

CODE	BLADE W X L X D	LENGTH
65-2423	½ x 7½ x ½ in (3.0 x 191 x 13 mm)	10 in 254 mm



Elevators (Periosteal)

Adson Elevator

Curved

CODE	DESCRIPTION	BLADE WIDTH	LENGTH
65-1031	#2, Blunt Edge	¼ in 6.0 mm	6½ in 165 mm
65-1032	#3, Semi-Sharp Edge	¼ in 6.0 mm	6½ in 165 mm

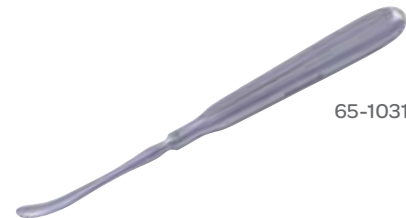

65-1031

Carroll Periosteal Elevator

Double-Ended

CODE	BLADE WIDTH	LENGTH
65-2549	½ in (3 mm) and ¾ in (10 mm)	5½ in 140 mm



Elevators (Periosteal)

Cloward Osteophyte Periosteal Elevator

CODE	DESCRIPTION	LENGTH
57-5038	90° Tip	8 in 203 mm



Cushing "Little Joker" Periosteal Elevator

CODE	DESCRIPTION	BLADE WIDTH	LENGTH
65-1047	Hollow Handle	¼ in 6.0 mm	6 in 152 mm
65-1048	Solid Handle	¼ in 6.0 mm	7½ in 191 mm



65-1047

Cushing Periosteal Elevator

Sharp

CODE	DESCRIPTION	BLADE WIDTH	LENGTH
65-1075	Rounded Edge	⅝ in 16 mm	7¼ in 184 mm
65-1076	Square Edge	⅝ in 16 mm	7¼ in 184 mm
65-1050	Narrow	¼ in 6.0 mm	8⅞ in 206 mm

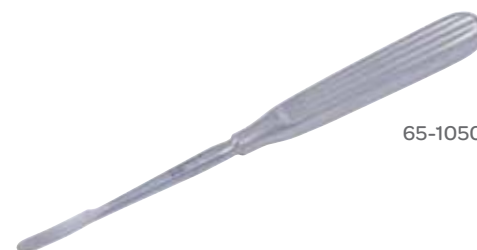

65-1050

Hoehn Periosteal Elevator

CODE	SIZE	BLADE WIDTH	LENGTH
65-1001	#1	⅝ in 8 mm	7 in 178 mm
65-1003	#1	¾ in 20 mm	7½ in 191 mm
65-1002	#2	⅝ in 15 mm	7¼ in 184 mm



65-1002

Elevators (Periosteal)

Iowa University Periosteal Elevator

CODE	BLADE WIDTH		LENGTH	
65-1080	1 $\frac{1}{16}$ in	17 mm	7 $\frac{1}{4}$ in	184 mm



Key Periosteal Elevator

CODE	BLADE WIDTH		LENGTH	
65-2510	$\frac{1}{4}$ in	6.0 mm	7 $\frac{1}{2}$ in	191 mm
65-2511	$\frac{3}{8}$ in	10 mm	7 $\frac{1}{2}$ in	191 mm
65-2512	$\frac{1}{2}$ in	13 mm	7 $\frac{1}{2}$ in	191 mm
65-2513	$\frac{3}{4}$ in	19 mm	7 $\frac{1}{2}$ in	191 mm
65-2514	1 in	25 mm	7 $\frac{1}{2}$ in	191 mm



Langenbeck Periosteal Elevator

CODE	DESCRIPTION	BLADE WIDTH		LENGTH	
65-1115	Narrow	$\frac{1}{4}$ in	6.0 mm	8 $\frac{1}{4}$ in	210 mm
65-1116	Wide	1 $\frac{1}{16}$ in	17 mm	7 $\frac{1}{2}$ in	191 mm



Love-Adson Periosteal Elevator

CODE	DESCRIPTION	BLADE WIDTH		LENGTH	
65-1110	Semi-Sharp	$\frac{3}{16}$ in	5.0 mm	6 $\frac{1}{2}$ in	165 mm



Elevators (Periosteal)

Molt Periosteal Elevator

CODE	DESCRIPTION	LENGTH
32-3420	#9	7¼ in 184 mm



Osteophyte Periosteal Elevator

CODE	DESCRIPTION	LENGTH
65-1064	Periosteal Elevator	8 in 203 mm



Periosteal Elevator

CODE	DESCRIPTION	LENGTH
65-1056	#1	8 in 203 mm
65-1057	#2	8 in 203 mm
65-1058	#3	8 in 203 mm



65-1056

Elevators (Sharp)

Sharp Elevator

CODE	DESCRIPTION	WIDTH
65-1121	Curved	5 mm



Elevators (Staphylorrhaphy)

Cushing Staphylorrhaphy Elevator

Round Handle

CODE	BLADE WIDTH	LENGTH
65-1045	$\frac{7}{16}$ in 11 mm	8½ in 216 mm

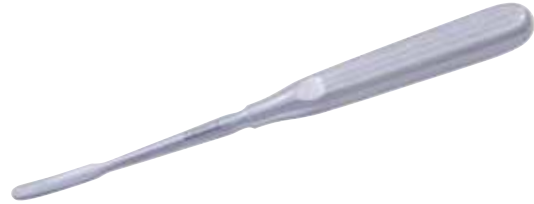

Presbyterian Hospital Staphylorrhaphy Elevator

Double-Ended

CODE	DESCRIPTION	LENGTH
65-1006	Curved, Semi-Sharp and Sharp Blades	7 in 178 mm

Image Not Available



Elevators

Malis Elevator

CODE	DESCRIPTION	LENGTH
80-1537	Curved Stainless Steel Shafts, Curved Tip, Titanium Handles, Width 3.5 mm	7¼ in 184 mm
57-5780	Bayonet	8 in 203 mm



Presbyterian Hospital Elevator

CODE	DESCRIPTION	LENGTH
57-3512	Straight	7 in 178 mm



Elevators

Rhoton Elevator

Titanium

CODE	DESCRIPTION	LENGTH
58-6010T	Curved Tip	7½ in 191 mm

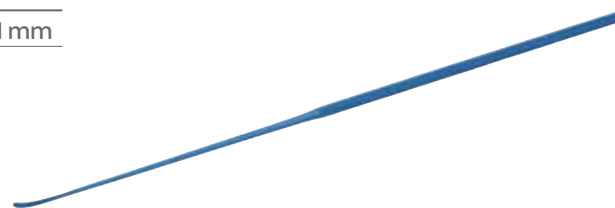

Woodson Elevator

CODE	DESCRIPTION	LENGTH
57-3515	Double-Ended	7⅞ in 181 mm
57-3517	Double-Ended	10 in 250 mm



Woodson Elevator-Spatula

CODE	DESCRIPTION	BLADE SIZE W X D X L
59-1000	Semi-Sharp, Double-Ended	⅛ x ½ x 10 in 3.0 x 13 x 254 mm

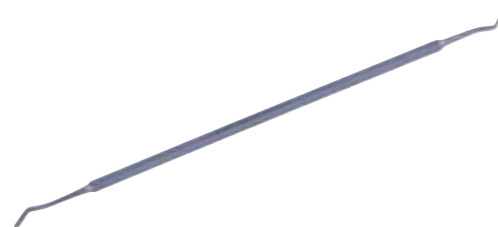

Enucleators (Transsphenoidal)

Hardy Enucleator

CODE	DESCRIPTION	TIP WIDTH	LENGTH
80-1311	Left, Micro	2.4 mm	9¼ in 235 mm
80-1325	Left	2.6 mm	9¼ in 235 mm
80-1312	Right, Micro	2.4 mm	9¼ in 235 mm
80-1326	Right	2.6 mm	9¼ in 235 mm
80-1329	Reverse Curve	2.6 mm	9¼ in 235 mm



Enucleators (Transsphenoidal)

Hardy Enucleator

Bayonet

CODE	DESCRIPTION	WORKING DISTANCE	LENGTH
80-1328	Three Prong	3½ in 89 mm	8¼ in 205 mm



Hardy Transsphenoidal Bayonet Enucleator

Standard

CODE	DESCRIPTION	LENGTH
58-7558	Left	9½ in 241 mm
58-7560	Right	9½ in 241 mm

Image Not Available



Micro Transsphenoidal Enucleator

CODE	DESCRIPTION	LENGTH
57-3572	Left	9½ in 241 mm
57-3573	Right	9½ in 241 mm



57-3572

Forceps (Alligator)

Hoen Alligator Forceps

1x2 Teeth

CODE	TIP WIDTH	SHAFT LENGTH
30-1230	2.2 mm	5½ in 140 mm

Tip



Forceps (Bayonet)

D'Errico Bayonet Forceps

CODE	DESCRIPTION	LENGTH
58-1547	Serrated	8 ³ / ₄ in 222 mm
58-1548	1x2 Teeth	8 ³ / ₄ in 222 mm



58-1547

Hoen Bayonet Forceps

CODE	DESCRIPTION	LENGTH
58-1550	Serrated	7 ⁵ / ₈ in 219 mm



Yasargil Bayonet Forceps

CODE	DESCRIPTION	LENGTH
59-2342M	Tip Angled Down 60°	8 ³ / ₄ in 220 mm
59-2342	Straight	8 ³ / ₄ in 220 mm
58-1544	Blunt Tips	9 ¹ / ₁₆ in 231 mm
58-1546	Sharp Tips	9 ¹ / ₁₆ in 231 mm



59-2342M

Forceps (Bone Cutting)

Horsley Bone Cutting Forceps

CODE	DESCRIPTION	LENGTH
30-1298	Double-Action, Curved Shaft, Angular Jaw	10 ¹ / ₂ in 267 mm

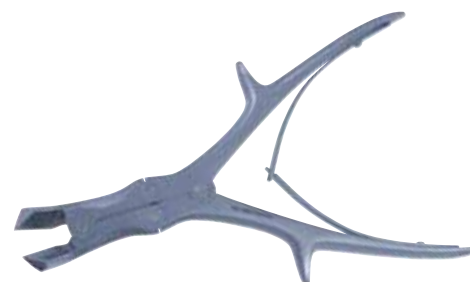

Forceps (Bone Cutting)

Liston Bone Cutting Forceps

CODE	DESCRIPTION	LENGTH
30-1310	Straight	5½in 140 mm



Ruskin Bone Cutting Forceps

CODE	DESCRIPTION	LENGTH
30-1290	Double-Action	7¼in 184 mm



Stille-Liston Bone Forceps

Double-Action

CODE	DESCRIPTION	LENGTH
30-1295	Straight	10½in 267 mm
30-1296	Curved	10½in 267 mm

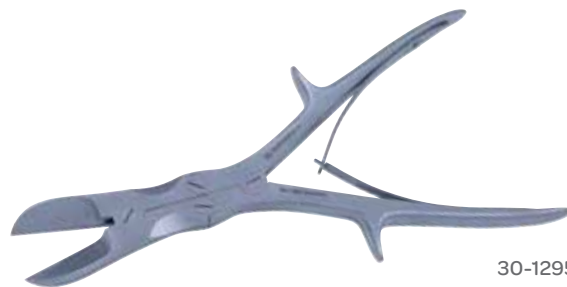

30-1295

Forceps (Brain Tumor)

Brigham Brain Tumor Forceps

CODE	RING JAW DIAMETER	LENGTH
30-1117	⅜in 10 mm	7⅜in 187 mm



Forceps (Cup)

Malis Cup Forceps

Bayonet

CODE	DESCRIPTION	LENGTH
80-1527	Small Cup, 2.75 x 2.0 mm	8½ in 216 mm
80-1528	Medium Cup, 3.5 x 2.75 mm	8½ in 216 mm
80-1529	Large Cup, 4.75 x 3.50 mm	8½ in 216 mm



80-1527

Forceps (Dressing)

Adson Dressing Forceps

CODE	DESCRIPTION	TIP WIDTH	WORKING DISTANCE	LENGTH
30-4214	Delicate Tip	0.8 mm		5 in 127 mm
30-1185	Standard Tip	1.2 mm		5 in 127 mm
30-1190	Standard Tip	2 mm		7 in 178 mm
30-1191	Bayonet Shape	2 mm	3⅝ in 92 mm	7½ in 191 mm



30-1185

Cushing Dressing Forceps

Serrated Handle

CODE	DESCRIPTION	TIP WIDTH	WORKING DISTANCE	LENGTH
30-1150		1.5 mm		7 in 178 mm
30-1152	Extra Fine Tip	1.3 mm		7 in 178 mm
30-1154		1.8 mm		7¾ in 197 mm
30-1155	Bayonet Shape, Dissecting End	1.8 mm	3 in 76 mm	7¼ in 184 mm
30-1203	Bayonet Shape	2.1 mm	3¼ in 83 mm	8¾ in 248 mm

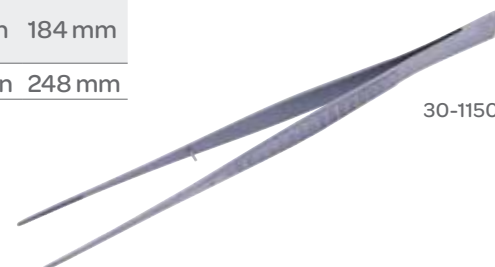

30-1150

Forceps (Dressing)

Gerald Dressing Forceps

Serrated

CODE	DESCRIPTION	TIP WIDTH	WORKING DISTANCE		LENGTH	
30-1214	Straight	1.1 mm			7 in	178 mm
30-1216	Bayonet Shape	1.3 mm	3 ½ in	89 mm	7 ½ in	191 mm



30-1214

Hoen Dressing Forceps

Serrated, Gutsch Handle

CODE	DESCRIPTION	TIP WIDTH	WORKING DISTANCE		LENGTH	
30-1165	Bayonet Shape	2.0 mm	3 in	76 mm	7 ¾ in	197 mm



Jansen Dressing Forceps

Serrated

CODE	DESCRIPTION	TIP WIDTH	WORKING DISTANCE		LENGTH	
30-1160	Bayonet	1.8 mm	4 ⅜ in	121 mm	8 ½ in	216 mm
30-6995	Bayonet	2.0 mm	3 ⅛ in	80 mm	6 ½ in	165 mm

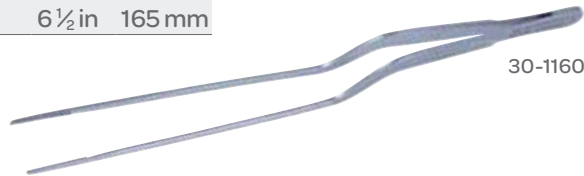

30-1160

Rhoton Dressing Forceps

Serrated

CODE	DESCRIPTION	TIP WIDTH	LENGTH	
80-1732	Titanium	1.8 mm	7 in	178 mm



Semken Dressing Forceps

CODE	DESCRIPTION	TIP WIDTH	LENGTH	
30-1180	Serrated	1.3 mm	5 in	127 mm



Forceps (Dural)

Rhoton Dura Forceps

Titanium

CODE	DESCRIPTION	TIP WIDTH	LENGTH
80-1731	1x2 Teeth	1.0 mm	7 in 178 mm

Tip



Forceps (Hypophyseal)

Adson Hypophyseal Bayonet Forceps

CODE	DESCRIPTION	CUP	LENGTH
59-4410	Straight	6 mm	9 in 229 mm
59-4411	Curved Up	6 mm	9 in 229 mm

Image Not Available



Adson Hypophyseal Forceps

Straight, Bayonet Shape

CODE	WORKING DISTANCE	CUP I.D.	LENGTH
30-1000	4½ in 114 mm	¼ in 6.0 mm	9 in 229 mm



Forceps (Micro)

E-Series Forceps

Titanium, Ring Tip, Straight

CODE	DESCRIPTION	TIP WIDTH	LENGTH
80-6001	Ring Tip	1.0 mm	6 in 152 mm
80-6002	Ring Tip, Serrated	1.0 mm	6 in 152 mm

Tip

80-6002



Forceps (Micro)

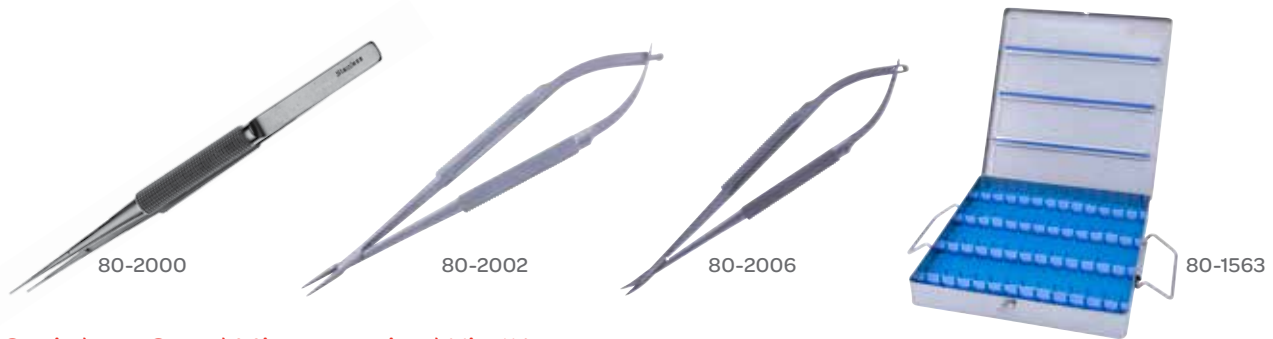

Stainless Steel Microsurgical Kit #1

CODE	DESCRIPTION	TIP WIDTH	QTY	LENGTH
80-2030	Stainless Steel Microsurgical Kit #1 (Includes Items Below)			5½ in 140 mm
80-2000	Micro Forceps, Straight	0.3 mm	2	5½ in 140 mm
80-2002	Needle Holder Straight	0.5 mm	1	5½ in 140 mm
80-2003	Needle Holder Curved	0.5 mm	1	5½ in 140 mm
80-2005	Micro Scissors Straight		1	5½ in 140 mm
80-2006	Micro Scissors Curved		1	5½ in 140 mm
80-1563	Microcare Instrument Case 10½ x 1¼ x 15 in (267 x 32 x 38 mm)			



Stainless Steel Microsurgical Kit #2

CODE	DESCRIPTION	TIP WIDTH	LENGTH
80-2031	Stainless Steel Microsurgical Kit #2 (Includes one each of the Items Below)		7 in 178 mm
80-2009	Micro Forceps, Straight	0.3 mm	7 in 178 mm
80-2010	Micro Forceps, Straight	0.7 mm	7 in 178 mm
80-2012	Needle Holder Straight	0.5 mm	7 in 178 mm
80-2013	Needle Holder Curved	0.5 mm	7 in 178 mm
80-2015	Micro Scissors Straight		7 in 178 mm
80-2016	Micro Scissors Curved		7 in 178 mm
80-2018	Micro Tying Forceps Straight	0.7 mm	7 in 178 mm
80-2019	Micro Tying Forceps Curved	0.7 mm	7 in 178 mm
80-1562	Microcare Instrument Case 10½ x 1¼ x 15 in (267 x 32 x 38 mm)		

Forceps (Micro)

Micro Alligator Forceps

CODE	DESCRIPTION	JAW	SHAFT LENGTH	
58-4610	Straight	0.5 mm	5 in	140 mm
58-4613	Left	0.5 mm	5 in	140 mm
58-4602	Right	0.5 mm	5 in	140 mm

Image Not Available



Forceps (Micro Bayonet)

Yasargil Micro Bayonet Forceps

CODE	DESCRIPTION	LENGTH	
58-1566	0.9 mm Tips	9 ½ in	241 mm

Image Not Available



Forceps (Micro Cup)

Rhoton Micro Cup Forceps

Alligator Action

CODE	DESCRIPTION	TIP WIDTH	LENGTH	
53-4005	Straight	1.0 mm	6 in	152 mm
53-4008	Straight	2.0 mm	6 in	152 mm
53-4007	Left	1.0 mm	6 in	152 mm
53-4006	Right	1.0 mm	6 in	152 mm



53-4007

Forceps (Micro Cup Pituitary)

Micro Cup Pituitary Forceps

Semi-Malleable

CODE	TIP WIDTH	LENGTH	
53-4009	1.0 mm	7 ⅞ in	200 mm
53-4010	2 mm	7 ⅞ in	200 mm



53-4010

Forceps (Microsurgical)

Decker Microsurgical Forceps

Serrated Jaws

CODE	DESCRIPTION	TIP WIDTH	LENGTH
30-4856	Alligator Action	1.4 mm	6 in 152 mm

Forceps (Neurovascular)

Spetzler Neurovascular Forceps

Titanium, Bayonet

CODE	DESCRIPTION	WORKING DISTANCE		LENGTH	
80-1905	Straight Tip	4 in	100 mm	9½ in	241 mm
80-1906	30° Angled Tip	4 in	100 mm	9½ in	241 mm



80-1905

Forceps (Pituitary)

D'Errico Pituitary Forceps

Bayonet Shape

CODE	WORKING DISTANCE		CUP I.D.		LENGTH	
30-1204	3½ in	89 mm	¼ in	6.0 mm	3½ in	89 mm



Forceps (Scalp)

Dandy Classic Scalp Forceps

CODE	DESCRIPTION	TEETH	LENGTH
32-4160	Curved on Side, Bright Finish	Serrated	5½ in 140 mm
32-4161	Curved on Side, Bright Finish	Serrated, 1x2 Teeth	5½ in 140 mm



32-4161

Forceps (Scalp)

Dandy Classic Scalp Forceps

CODE	DESCRIPTION	TEETH	LENGTH
33-4160	Curved on Side, Mirror Finish	Serrated	5 ½ in 140 mm
33-4161	Curved on Side, Mirror Finish	1 x 2 Teeth	5 ½ in 140 mm
34-4160	Curved on Side	Serrated	5 ½ in 140 mm
34-4161	Curved on Side	1 x 2 Teeth	5 ½ in 140 mm

Image Not Available



Hoehn Scalp Hemostatic Forceps

CODE	DESCRIPTION	LENGTH
30-1115	Curved on Side, Serrated	5 ¾ in 137 mm

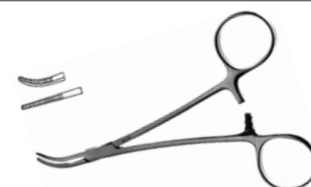

Raimondi Scalp Forceps

Infant

CODE	DESCRIPTION	TEETH	LENGTH
30-1360	Curved on Side	1 x 2	5 in 127 mm



Forceps (Spoon)

Spoon Forceps

Bayonet

CODE	TIP WIDTH	LENGTH
80-2060	2 mm	4.0 in 100 mm
80-2063	2 mm	4.0 in 100 mm
80-2061	4 mm	4.0 in 100 mm
80-2064	4 mm	4.0 in 100 mm
80-2062	6 mm	4.0 in 100 mm
80-2065	6 mm	4.0 in 100 mm

Image Not Available



Yasargil Spoon Forceps

CODE	TIP WIDTH	LENGTH
58-4751	5.0 mm	9 ½ in 421 mm

Image Not Available



Forceps (Tendon-Pulling)

Carroll Tendon-Pulling Forceps

CODE	SHAFT LENGTH	LENGTH
30-2540	5 in 127 mm	7½ in 191 mm



Forceps (Tissue)

Brain Tissue Forceps

CODE	TEETH	TIP WIDTH	LENGTH
30-1172	1x2 Teeth	1.0 mm	7 in 178 mm



Cushing Tissue Forceps

Dissecting End, 1 x 2 Teeth

CODE	DESCRIPTION	TIP WIDTH	LENGTH
30-1143	Gutsch Handle	1.3 mm	7 in 178 mm
30-1142	Gutsch Handle	1.7 mm	7 in 178 mm
30-1140	Serrated Handle	1.5 mm	7 in 178 mm
30-1145	Serrated Handle, With Gerald -Type Tips	1.6 mm	7¾ in 197 mm



D'Errico Bayonet Tissue Forceps

CODE	DESCRIPTION	TIP WIDTH	LENGTH
30-1201	1x2 Teeth	2.4 mm	8¾ in 222 mm



Forceps (Tissue)

Ferris-Smith Tissue Forceps

CODE	DESCRIPTION	TIP WIDTH	LENGTH
30-1132	2 x 3 Teeth	3.9 mm	6 ³ / ₄ in 171 mm



General Surgery Tissue Forceps

CODE	DESCRIPTION	LENGTH
67-7583	3.0 mm	8 in 203 mm

Image Not Available



Gerald Tissue Forceps

CODE	DESCRIPTION	TIP WIDTH	LENGTH
30-1210	Straight, 1 x 2 Teeth	1.3 mm	7 in 178 mm
30-1213	Bayonet Shape, 1 x 2 Teeth, Working Distance: 3 ¹ / ₂ in (89 mm)	1.3 mm	7 ¹ / ₂ in 191 mm
32-3531	Fine Tungsten Carbide Inserts	1 mm	7 in 178 mm
32-3532	Fine Tungsten Carbide Inserts	1 mm	10 in 254 mm



32-3531

Hoehn Tissue Forceps

Bayonet Shape, 1 x 2 Teeth, Gutsch Handle

CODE	WORKING DISTANCE	TIP WIDTH	LENGTH
30-1166	3 in 76 mm	2.1 mm	7 ³ / ₄ in 197 mm

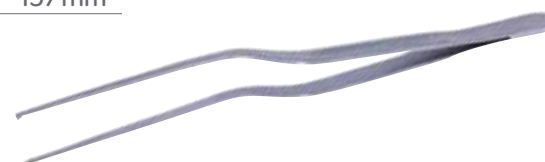

Forceps (Tissue)

Semkin Tissue Forceps

CODE	TIP WIDTH	LENGTH
30-1170	1.3 mm	5 in 127 mm



Forceps (Transsphenoidal)

Hardy Dressing Forceps

Bayonet

CODE	WORKING DISTANCE	TIP WIDTH	LENGTH
30-1205	4½ in 114 mm	1.0 mm	8¼ in 210 mm

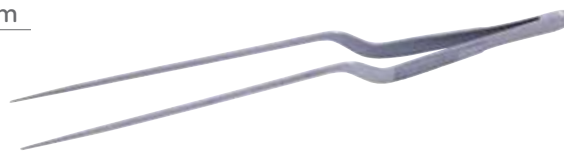

Forceps (Tumor)

Rhoton Tumor Forceps

Bayonet, Titanium, Serrated, Ring Tip

CODE	WORKING DISTANCE	TIP WIDTH	LENGTH
80-1736	3½ in 89 mm	4.0 mm	8½ in 216 mm
80-1748	3½ in 89 mm	4.0 mm	9½ in 241 mm



Forceps (Tumor Grasping)

Yasargil Bayonet Tumor Grasping Forceps

CODE	CUP SIZE	LENGTH
58-4656	3.0 mm, with Teeth	8¾ in 222 mm
58-4645	3.0 mm Cup	8¾ in 222 mm
58-4652	3.0 mm, Flat Serrated	8¾ in 222 mm
58-4654	5.0 mm, Flat Serrated	8¾ in 222 mm

Image Not Available



Forceps (Tying)

E-Series Tying Forceps

Titanium

CODE	DESCRIPTION	TIP WIDTH	LENGTH
80-6630	Straight	0.7 mm	6 in 152 mm



Forceps (Utility)

E-Series Utility Forceps

Titanium

CODE	DESCRIPTION	TIP WIDTH	LENGTH
80-6631	Straight	0.3 mm	6 in 152 mm



Forceps (Watchmaker)

Penfield Watchmaker Forceps

CODE	DESCRIPTION	TIP WIDTH	LENGTH
30-1194	Forceps	0.9 mm	7 in 178 mm



Forceps

Clip Applying Forcep

Straight, Standard

CODE	DESCRIPTION	LENGTH
58-5048	Bayonet, Mini	8 in 200 mm

Image Not Available



Forceps

Bayonet

CODE	DESCRIPTION	TIP WIDTH	LENGTH
80-2068	Curved	0.75 mm	3 $\frac{3}{10}$ in 100 mm
80-2066	Smooth	0.5 mm	3 $\frac{3}{10}$ in 100 mm

Image Not Available



Forceps

Jewelers Forceps

CODE	DESCRIPTION	LENGTH
30-6712	#3	4 ³ / ₄ in 121 mm
30-6713	#3C	4 ⁵ / ₁₆ in 110 mm
30-6714	#4	4 ¹ / ₄ in 108 mm
30-6715	#5	4 ⁵ / ₁₆ in 110 mm



Malis Forceps

Bayonet, Titanium

CODE	DESCRIPTION	BLUNT TIP	WORKING DISTANCE	LENGTH
80-1506	90° Curved Down	0.75 mm	3 ³ / ₄ in 95 mm	8 ¹ / ₂ in 216 mm
80-1504	90° Curved Up	0.75 mm	3 ³ / ₄ in 95 mm	8 ¹ / ₂ in 216 mm

Image Not Available



Malis Forceps

Straight, Titanium

CODE	DESCRIPTION	TIP WIDTH	LENGTH
80-1500	Blunt	0.75 mm	6 in 152 mm
80-1501	Fine	0.5 mm	6 in 152 mm
80-1508	Extra Fine Tip	0.25 mm	6 in 152 mm



Malis Forceps

Bayonet, Titanium, Straight

CODE	DESCRIPTION	TIP WIDTH	WORKING DISTANCE	LENGTH
80-1502	Blunt Tip	0.75 mm	3 ³ / ₄ in 95 mm	8 ³ / ₄ in 222 mm
80-1503	Fine Tip	0.5 mm	3 ³ / ₄ in 95 mm	8 ³ / ₄ in 222 mm
80-1509	Extra-Fine Tip	0.25 mm	3 ³ / ₄ in 95 mm	8 ³ / ₄ in 222 mm



Forceps

Malis Forceps

Bayonet, Titanium, Fine Tip

CODE	DESCRIPTION	TIP WIDTH	WORKING DISTANCE	LENGTH
80-1507	Angled Down	0.5 mm	3 ¾ in 95 mm	8 ½ in 216 mm
80-1505	Angled Up	0.5 mm	3 ¾ in 95 mm	8 ½ in 216 mm

Image Not Available



Rhoton Forceps

Titanium

CODE	DESCRIPTION	TIP WIDTH	LENGTH
80-1700	Straight, Extra-Fine	0.3 mm	7 in 178 mm
80-1701	Straight, Fine	0.7 mm	7 in 178 mm
80-1702	Bayonet, Fine	0.5 mm	8 ½ in 216 mm
80-1703	Bayonet, Regular	1.0 mm	8 ½ in 216 mm



80-1702

Hooks (Ball)

Murphy Ball Hook

CODE	DESCRIPTION	LENGTH
57-3800	Ball Hook	9 in 229 mm

Image Not Available



Hooks (Cervical Nerve)

Cervical Micro Nerve Hook

CODE	SIZE	HANDLE WIDTH	WORKING DISTANCE	LENGTH
46-2646	Micro	0.6 in 15 mm	4.1 in 104 mm	9 ½ in 241 mm
46-2647	Ultra Micro	0.6 in 15 mm	4.1 in 104 mm	9 ½ in 241 mm



46-2646

Hooks (Dissecting)

Adson Dissecting Hook

Rough-End Handle

CODE	DESCRIPTION	TIP DIAMETER	HOOK DEPTH		LENGTH	
38-1060	Sharp	0.9 mm	$\frac{3}{16}$ in	5.0 mm	$7\frac{3}{4}$ in	197 mm
38-1061	Blunt	0.9 mm	$\frac{3}{16}$ in	5.0 mm	$7\frac{3}{4}$ in	197 mm
67-7429	Blunt	0.9 mm	$\frac{3}{16}$ in	5.0 mm	$7\frac{3}{4}$ in	197 mm



38-1060

Hooks (Dural)

Adson Dural Hook

CODE	DESCRIPTION	LENGTH	
20-2722	Sharp	8 in	203 mm
20-2723	Blunt	8 in	203 mm

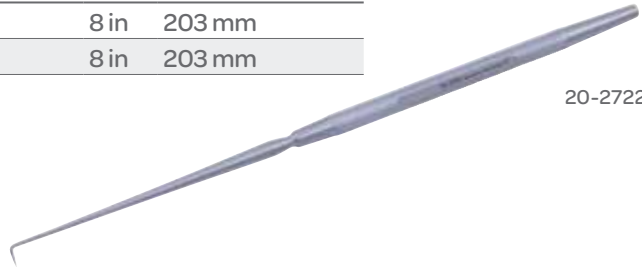

20-2722

Corkscrew Dural Hook

Reversible Handle

CODE	TIP DIAMETER	LENGTH	
38-1045	4.0 mm	$6\frac{1}{2}$ in	165 mm



Hooks (Dural)

Cushing Dural Hook

CODE	DESCRIPTION	TIP DIAMETER	LENGTH
38-1028	Dural Hook	2.0 mm	5½ in 140 mm



Dural Hook

CODE	DESCRIPTION	TIP DIAMETER	LENGTH
38-1038	Dural Hook	2.0 mm	6½ in 165 mm



Frazier Dural Hook

CODE	DESCRIPTION	TIP DIAMETER	LENGTH
38-1040	Dural Hook	0.4 mm	5 in 127 mm



Lahey Clinic Dural Hook

CODE	DESCRIPTION	LENGTH
38-1042	Sharp, Depth 2.8 mm	5¼ in 133 mm



Hooks (Exploration & Coagulation)

Caspar Exploration & Coagulation Hook

Insulated Shaft, Ball Probe Tip

CODE	DESCRIPTION	LENGTH
57-5008	#1, 90° Angle, Small	9 ³ / ₄ in 248 mm
57-5009	#2, 90° Angle, Medium	9 ³ / ₄ in 248 mm
57-5010	#3, 90° Angle, Large	9 ³ / ₄ in 248 mm
57-5011	#4, 90° Angle, Extra-Large	9 ³ / ₄ in 248 mm

Image Not Available



Hooks (Ganglion)

Cushing Gasserian Ganglion Hook

CODE	DESCRIPTION	HOOK DEPTH	LENGTH
38-1030	Blunt	³ / ₁₆ in 5.0 mm	9 in 229 mm
67-7430	Hook	³ / ₁₆ in 5.0 mm	11 in 279 mm



38-1030

Hooks (Nerve)

Cushing Nerve Hook

CODE	BALL TIP	LENGTH
20-2231	4.0 mm	7 ¹ / ₂ in 191 mm
20-2232	6.0 mm	7 ¹ / ₂ in 191 mm

Image Not Available



Hooks (Nerve)

Dandy Nerve Hook

Blunt

CODE	DESCRIPTION	LENGTH	
38-1080	Straight	8 ⁵ / ₈ in	219 mm
57-5001	Straight	9 in	229 mm
67-7431	Straight	10 in	254 mm
57-5002	Left	9 in	229 mm
57-5003	Right	9 in	229 mm



38-1080

Hoer Nerve Hook

Solid Triangular Handle, Blunt

CODE	DESCRIPTION	TIP DIAMETER	HOOK DEPTH		LENGTH	
38-1085	Straight	1.0 mm	¼ in	7.0 mm	8 ³ / ₄ in	222 mm
57-5000	Straight	1.0 mm	¼ in		9 in	230 mm
67-7432	Straight		¼ in	7.0 mm	10 in	254 mm
57-4999	Angled	1.0 mm	¼ in		9 in	230 mm



38-1085

Karlin Micro Nerve Hook

CODE	DESCRIPTION	LENGTH	
46-3171	Nerve Hook	8 ¹ / ₂ in	216 mm



Hooks (Nerve)

Lucae Nerve Hook

Probe Tip

CODE	DESCRIPTION	LENGTH
20-2201	Small	5½ in 140 mm
20-2202	Medium	5½ in 140 mm

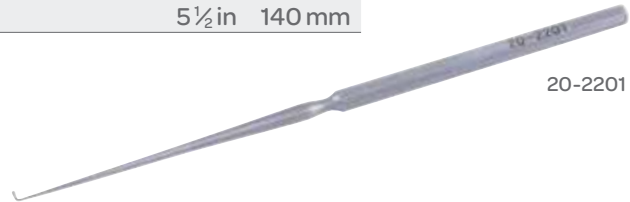

20-2201

Malis Nerve Hook

CODE	DESCRIPTION
57-5771	2.0 mm

Image Not Available



Malis Nerve Hook

Titanium Handle

CODE	DESCRIPTION	LENGTH
58-6063T	Ball Tip 3 mm	7¼ in 184 mm
58-6065T	Ball Tip 3 mm	7¼ in 184 mm

Image Not Available



Hooks (Nerve)

Malis Nerve Hook

Stainless Steel Shaft, Titanium Handle

CODE	DESCRIPTION	TIP WIDTH	LENGTH
80-1531	Ball	3 mm	7¼ in 184 mm
80-1532	Blunt	2 mm	7¼ in 184 mm
80-1533	Blunt	3 mm	7¼ in 184 mm
67-7433	Ball	3 mm	10 in 254 mm
67-7434	Blunt	2 mm	10 in 254 mm
67-7435	Blunt	3 mm	10 in 254 mm



Nerve Hook

CODE	DESCRIPTION	LENGTH
20-2057	7 mm Wide, Blunt	6¼ in 159 mm



Rhoton Nerve Hook

Titanium

CODE	DESCRIPTION	TIP WIDTH	LENGTH
80-1688	90°, Semi-Sharp	0.5 mm	7½ in 191 mm
80-1689	90°, Blunt	0.8 mm	7½ in 191 mm
80-1690	40°, Semi-Sharp	0.7 mm	7½ in 191 mm
67-7436	90°, Semi-Sharp	0.5 mm	10 in 254 mm
67-7437	90°, Blunt	0.8 mm	10 in 254 mm
67-7438	40°, Semi-Sharp	0.7 mm	10 in 254 mm

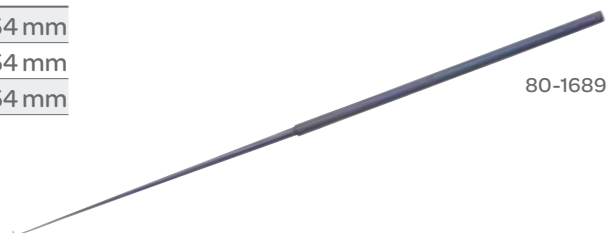

Hooks (Nerve)

Scoville Hook

CODE	LENGTH
13-1004C	2 in 51 mm

Image Not Available



Scoville Nerve Hook

CODE	DESCRIPTION	LENGTH
57-5045	Double-Ended	11 3/4 in 300 mm

Image Not Available



Sisson Nerve Hook

CODE	DESCRIPTION
57-5005	Nerve Hook

Image Not Available



Ultra Micro Nerve Hook

CODE	DESCRIPTION	LENGTH
46-3172	Nerve Hook	8 1/2 in 216 mm

Image Not Available



Hooks (Nerve)

Weary Nerve Hook

Black Finish, Fine, Blunt

CODE	TIP DIAMETER	HOOK DEPTH	LENGTH
38-1020	0.9 mm	$\frac{1}{8}$ in 3 mm	$7\frac{3}{4}$ in 197 mm



Hooks (Skin)

Carroll Skin Hook

CODE	DESCRIPTION	HOOK SIZE	LENGTH
38-2515	Sharp	$\frac{1}{8}$ in 3 mm	6 in 152 mm



Converse Skin Hook

CODE	DESCRIPTION	LENGTH
38-6638	Small, 3 mm, Sharp	$7\frac{1}{4}$ in 184 mm
38-6640	Large, 5 mm, Sharp	$7\frac{1}{4}$ in 184 mm



38-6638

Hooks (Skin)

Gilles Skin Hook

CODE	DESCRIPTION	LENGTH
38-2520	3 mm, Sharp	7 $\frac{1}{8}$ in 181 mm



Hooks (Spring)

Yasargil Spring Hook

CODE	LENGTH
57-6405	12 $\frac{1}{4}$ in 311 mm
57-6408	16 in 406 mm

Image Not Available



Hooks

Graham Hook

CODE	DESCRIPTION	LENGTH
57-0070	Blunt	6 $\frac{1}{2}$ in 165 mm

Image Not Available



Jannetta Hook

CODE	DESCRIPTION	LENGTH
58-6209A	45° Angle, Medium	7 $\frac{1}{2}$ in 191 mm

Image Not Available



Hooks

Rhoton Hook

Titanium

CODE	DESCRIPTION	LENGTH
58-6032T	45° Angle, Semi-Sharp	7½ in 191 mm
58-6030T	90° Angle, Semi-Sharp	7½ in 191 mm
58-6031	90° Angle, Dull	7½ in 191 mm

Image Not Available



Scoville Hook

CODE	DESCRIPTION	LENGTH
13-1005C	Hook	3 in 76 mm
57-5821	Hook	2 in 51 mm

Image Not Available



Knife Handles (Micro)

Micro Knife Handle

CODE	DESCRIPTION	LENGTH
58-7576	Vertical	8 in 203 mm



Knife Handles (Transsphenoidal)

Hardy Knife Handle

Bayonet

CODE	DESCRIPTION	WORKING DISTANCE	LENGTH
80-1314	Lateral	3½ in 90 mm	8⅞ in 205 mm
80-1313	Vertical	3½ in 90 mm	8⅞ in 205 mm



Knives (Angled)

Jannetta Angled Knife

CODE	DESCRIPTION	LENGTH
58-6201	Small	7½ in 191 mm
58-6202	Large	7½ in 191 mm



Knives (Arachnoid)

Stecher Arachnoid Knife

CODE	DESCRIPTION	TIP WIDTH	LENGTH
40-1020	Straight	1.5 mm	8 in 203 mm
40-1021	Angled Left	1.5 mm	8 in 203 mm
40-1022	Angled Right	1.5 mm	8 in 203 mm



Knives (Cordotomy)

Bucy Cordotomy Knife

CODE	BLADE	LENGTH
57-3851	6 mm, Forward Cutting	6½ in 165 mm



Knives (Ganglion)

Crile Gasserian Ganglion Knife

Double-Ended

CODE	TIP SIZES	LENGTH
40-1002	6 mm, 16 mm	8½ in 216 mm



Knives (Microvascular Arachnoid)

Yasargil Microvascular Knife

Arachnoid

CODE	DESCRIPTION	LENGTH
58-3305	Curved Up	7¼ in 184 mm



Knives (Tumor)

Tumor Knife

CODE	DESCRIPTION	LENGTH
80-2075	1 mm, Round	7⅞ in 200 mm
80-2076	3 mm, Round	7⅞ in 200 mm
80-2077	5 mm, Round	7⅞ in 200 mm



Knives

Knife

CODE	DESCRIPTION	LENGTH
57-3845	Hollow Handle, Sharp	8 in 203 mm



Ligature Instruments (Carrier)

Yasargil Ligature Carrier

Ball Probe Tip

CODE	DESCRIPTION	LENGTH	
58-3062	Long Curve	7¼ in	184 mm
58-3063	Full Curve	7¼ in	184 mm
58-3065	90° Angle	7¼ in	184 mm

Image Not Available



Ligature Instruments (Passer)

Malis Ligature Passer

Stainless Steel Shaft, Titanium Handles

CODE	HOOK SIZE	LENGTH	
80-1530	3 mm	7⅜ in	187 mm



Mallets

Heath Mallet

CODE	DESCRIPTION	HEAD DIMENSIONS		LENGTH	
32-3330	2 lbs 908 g	2½ x 1½ in	64 x 38 mm	7¼ in	184 mm

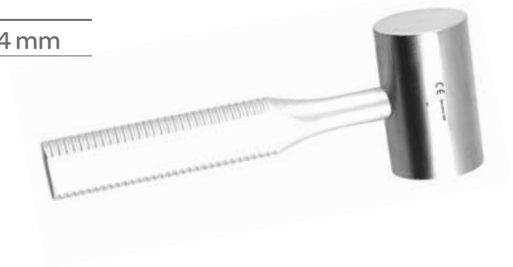

Mallets (Percussion)

Taylor Percussion Hammer

CODE	DESCRIPTION	LENGTH	
88-4000	Percussion Hammer	8 in	203 mm



Markers

Surgical Marker

Gentian Violet Dye, Sterile, Disposable, Packed with 6 in (152 mm) Ruler

CODE	DESCRIPTION	QTY
43-1030	Regular Tip	36/Box
43-1032	Micro Tip	36/Box



43-1030

Mirrors (Transsphenoidal)

Hardy Transsphenoidal Mirror

Bayonet Shape, Tip Width 5.0 mm

CODE	WORKING DISTANCE	LENGTH
80-1366	4 ½ in 114 mm	9 in 229 mm



Needle Holders (Bayonet)

Malis Bayonet Needle Holder

Titanium, With Lock

CODE	DESCRIPTION	LENGTH
58-5938T	Straight, Round Handle	8 ¾ in 222 mm



Needle Holders (Bayonet)

Rhoton Needle Holder

Titanium, Bayonet

CODE	DESCRIPTION	LENGTH
80-1746	Straight	9½ in 241 mm
80-1747	Curved	9½ in 241 mm

Image Not Available



Rhoton Needle Holder

Titanium

CODE	DESCRIPTION	TIP WIDTH	LENGTH
80-1726	Straight	0.9 mm	7 in 178 mm
80-1728	Straight, Bayonet	0.9 mm	8½ in 216 mm
80-1725	Curved, Fine Tip	0.5 mm	7 in 178 mm
80-1727	Curved	0.9 mm	7 in 178 mm
80-1729	Curved, Bayonet	0.9 mm	8½ in 216 mm



80-1726

Titanium Malis Bayonet Needle Holder

CODE	DESCRIPTION	TIP	LENGTH
59-5912	Straight	6 mm	7 in 178 mm

Image Not Available



Yasargil Bayonet Needle Holder

CODE	DESCRIPTION	LENGTH
59-2342	Straight	9 in 229 mm
59-2349	Straight	9 in 229 mm
59-2345	Curved	8¾ in 222 mm



59-2342

Needle Holders (Dural)

Adson Dural Needle Holder

CODE	DESCRIPTION	LENGTH
64-1000	Fenestrated Jaws	7¼ in 184 mm



Needle Holders (Micro)

E-Series Needle Holder

Curved, Titanium

CODE	DESCRIPTION	TIP WIDTH	LENGTH
80-6621	Extra Fine	0.5 mm	6 in 152 mm
80-6006	Fine Tip	0.7 mm	6 in 152 mm
80-6007	Standard Tip	1 mm	6 in 152 mm



80-6621

Micro Needle Holder

Stainless Steel

CODE	DESCRIPTION	TIP WIDTH	LENGTH
80-2002	Straight Tip	0.5 mm	5½ in 140 mm
80-2003	Curved Tip	0.5 mm	5½ in 140 mm



Tip

80-2002

Needle Holders (Neurovascular)

Spetzler Neurovascular Needle Holder

Titanium, Bayonet with Lock

CODE	TIP	WORKING DISTANCE	LENGTH
80-1909	30° Tip, Curved	4 in 102 mm	9½ in 241 mm

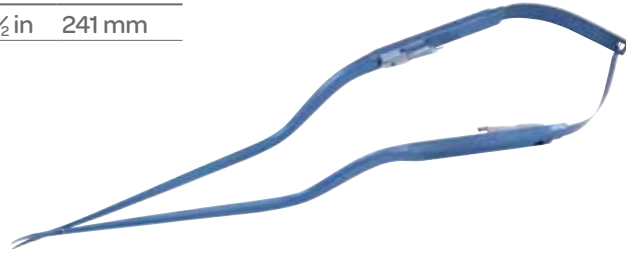

Needle Holders

Malis Needle Holder

Titanium

CODE	HANDLE DESCRIPTION	TIP DESCRIPTION	TIP WIDTH	LENGTH
80-1510	Straight		0.5 mm	6¾ in 171 mm
80-1511	Straight		0.5 mm	6¾ in 171 mm
80-1514	Straight	Fine	0.5 mm	6¾ in 171 mm
80-1515	Bayonet	Straight, Extra Fine	0.4 mm	8¾ in 222 mm
80-1512	Bayonet	Fine	0.6 mm	8¾ in 222 mm



80-1510

Needle Holder

CODE	DESCRIPTION	LENGTH
80-2069	Bayonet 2 mm x 6 mm	4 in 100 mm
80-2070	Bayonet 1 mm x 6 mm	4 in 100 mm

Image Not Available



Needles (Straight)

Rhoton #12 Straight Point Needle

Titanium

CODE	DESCRIPTION	TIP WIDTH	LENGTH
80-1691	Semi-Sharp	0.8 mm	7½ in 191 mm

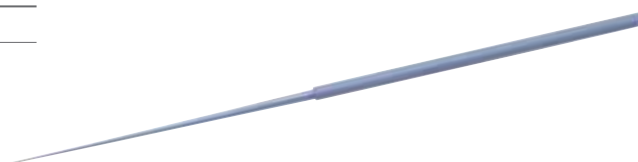

Needles (Ventricular)

Cone Ventricular Needle

With Two Holes, Luer Lock Hub

CODE	DESCRIPTION	LENGTH
57-7736	12 Gauge	3½ in 89 mm
57-7735	13 Gauge	3½ in 89 mm
57-7734	14 Gauge	3½ in 89 mm
57-7733	15 Gauge	3½ in 89 mm
57-7732	16 Gauge	3½ in 89 mm
57-7731	17 Gauge	3½ in 89 mm
57-7730	18 Gauge	3½ in 89 mm
57-7729	19 Gauge	3½ in 89 mm



Osteotomes (Spine)

Hoke Osteotome

CODE	DESCRIPTION	BLADE WIDTH	LENGTH
32-3439	Straight	3 mm	6 in 152 mm
32-3435	Straight	6 mm	6 in 152 mm
32-3436	Straight	10 mm	6 in 152 mm
32-3437	Straight	13 mm	6 in 152 mm
32-3438	Straight	16 mm	6 in 152 mm
32-3430	Curved	3 mm	6 in 152 mm
32-3431	Curved	6 mm	6 in 152 mm
32-3432	Curved	13 mm	6 in 152 mm
32-3434	Curved	16 mm	6 in 152 mm

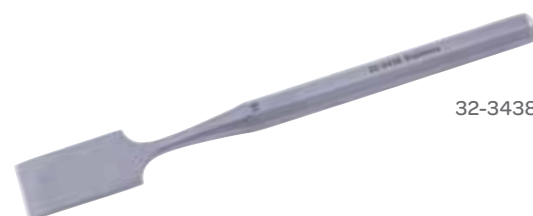

Probes (Ball)

Ball Probe

CODE	DESCRIPTION	LENGTH
57-3801	60° Angle, 2 mm	14 in 356 mm

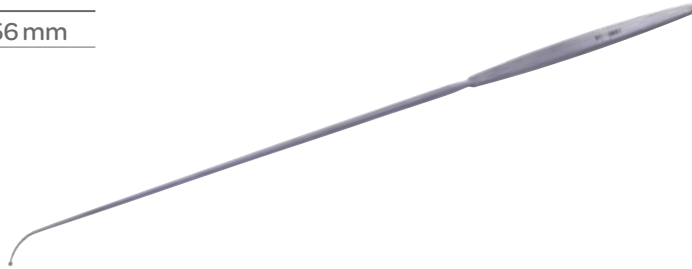

Probes (Double Forked)

Jannetta Double Forked Probe

CODE	DESCRIPTION	LENGTH
58-6212	Small, 30° Angle	7½ in 191 mm

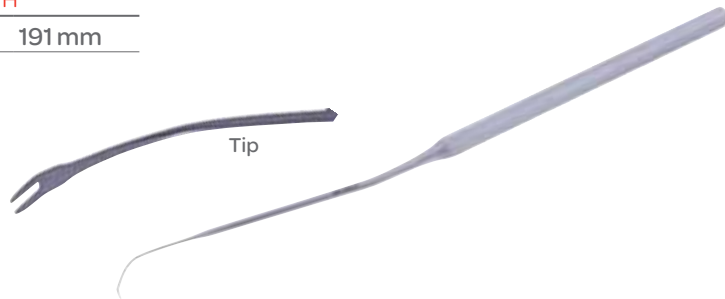

Probes (Micro)

Jacobson Micro Probe

CODE	DESCRIPTION	LENGTH
58-3020	Angled, Ball Tip	7¼ in 184 mm
58-3022	Straight, Double Ball Tip	7¼ in 184 mm

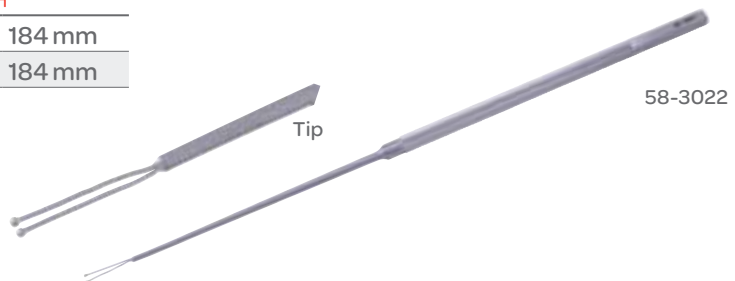

Probes

Jannetta Probe

CODE	DESCRIPTION	LENGTH
58-6208	Small, 45° Angle	7½ in 191 mm

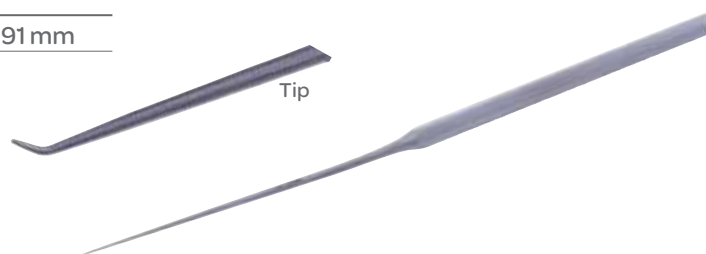

Punches (Skull)

Cone Skull Punch

CODE	DESCRIPTION	LENGTH
57-6111	Adult	9½ in 241 mm



Punches (Stella)

Hardy Stella Punch

CODE	DESCRIPTION	BITE	LENGTH
80-1344	40° Up	1 mm	7 in 178 mm
80-1340	40° Up	2 mm	7 in 178 mm
80-1341	90° Up	2 mm	7 in 178 mm
80-1343	40° Down	2 mm	7 in 178 mm
80-1342	90° Down	2 mm	7 in 178 mm

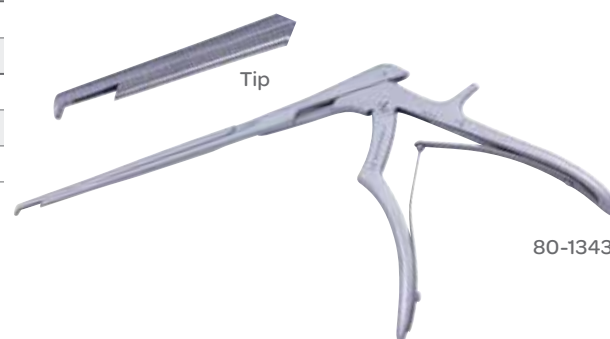

Pushers (Suture)

Jacobson Suture Pusher

CODE	DESCRIPTION	LENGTH
58-3055	Short Curve, Ball Probe Tip	7¼ in 184 mm

Image Not Available



Rasps (Bone)

Miller Bone Rasp

CODE	DESCRIPTION	LENGTH
26-1012	Double-Ended, 5 mm and 7 mm	7¼ in 184 mm

Image Not Available



Retractors (Cerebellar)

Miskimon Cerebellar Retractor

CODE	DESCRIPTION	BLADE WIDTH	BLADE DEPTH	LENGTH
50-1363	7 x 7 Sharp Prongs	1¼ in 32 mm	1⅜ in 35 mm	7½ in 191 mm
24-2810	Angled			8¾ in 222 mm

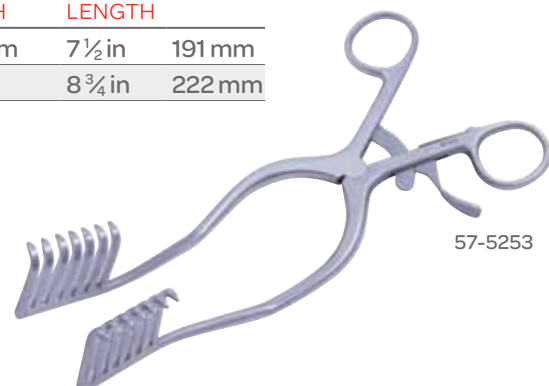

57-5253

Retractors (Crockard)



50-1670

Crockard Transoral Instrument Set

The Crockard Transoral Instrument Set is a coordinated set of instruments used to approach a large area of pathology from the sphenoid to the C3 vertebra via the transoral technique.

CODE	DESCRIPTION	QUANTITY
50-1670	Set Includes:	
50-1651	Crockard Transoral Retractor Body	1/Each
50-1652	Crockard Large Tongue Retractor Blade	1/Each
50-1653	Crockard Small Tongue Retractor Blade	1/Each
50-1654	Crockard 90° Retractor Blade	2/Each
50-1655	Crockard Curved Retractor Blade	2/Each
50-1656	Crockard Retractor Blade Connector	2/Each
50-1657	Crockard Suction Tube Holder, Short	1/Each
50-1658	Crockard Suction Tube Holder, Long	1/Each
50-1659	Crockard Hard Palate Retractor	1/Each
50-1660	Crockard Pharyngeal Retractor, Small	1/Each
50-1661	Crockard Pharyngeal Retractor, Large	1/Each
50-1662	Crockard Odontoid Peg Grasping Forceps	1/Each
50-1663	Crockard Ligament Grasping Forceps	1/Each
50-1664	Crockard Sterilizing/Storage Case	

Retractors (Crockard)



Crockard Hard Palate Retractor

CODE	DESCRIPTION	LENGTH		WIDTH	
50-1659	Hard Palate Retractor	4 ¼ in	108 mm	1 in	25 mm



Crockard Mid-Facial Osteotomy Retractor Plate

Uniquely and exclusively fashioned to function with Crockard Transoral Instrument Set (50-1670), especially Tongue Retractor Blades (50-1692 and 15-1653) and Retractor Body (50-1651). For surgery of middle and upper clivus and transpalatal incisions. Retracts soft and hard palate from skull as tongue blade retracts hard palate downward.

CODE	HANDLE LENGTH		BLADE DEPTH		LENGTH	
50-1668	6 in	152 mm	3 in	76 mm	6 in	152 mm

Retractors (Crockard)



50-1660

Crockard Pharyngeal Retractor

CODE	DESCRIPTION	LENGTH
50-1660	Small	7 in 177 mm
50-1661	Large	7½ in 190 mm



50-1654

Crockard Retractor Blade

CODE	DESCRIPTION	BLADE LENGTH	BLADE WIDTH	OVERALL LENGTH
50-1654	90° Retractor Blade	1½ in 38 mm	0.8 in 20 mm	5 in 127 mm
50-1655	Curved 180°	1½ in 38 mm	0.5 in 12 mm	5 in 127 mm



Crockard Retractor Blade Connector

CODE	DESCRIPTION	DIMENSIONS
50-1656	Retractor Blade Connector	1½ x 3⅜ in 38 x 81 mm

Retractors (Crockard)



Crockard Sterilizing & Storage Case

Custom Designed for the Crockard Transoral Instrument Set 50-1670

CODE	LENGTH	DIMENSIONS
50-1664	18 in 457 mm	10½ x 7¼ in 266 x 184 mm



Crockard Suction Tube Holder

CODE	DESCRIPTION	LENGTH
50-1657	Short	1½ in 38 mm
50-1658	Long	2 in 51 mm



Crockard Tongue Retractor Blade

CODE	DESCRIPTION	BLADE LENGTH	OVERALL LENGTH
50-1653	Small	3 in 76 mm	6 in 152 mm
50-1652	Large	3½ in 91 mm	6 in 152 mm

Retractors (Crockard)



Crockard Transoral Retractor Body

CODE	LENGTH	WIDTH
50-1651	6 in 152 mm	2¾ in 70 mm

Retractors (Decompression)



Decompression Retractor

CODE	DESCRIPTION	BLADE WIDTH	BLADE DEPTH	LENGTH
50-1060	Fenestrated Blade	½ in 13 mm	⅞ in 22 mm	8⅜ in 213 mm

Retractors (Greenberg)

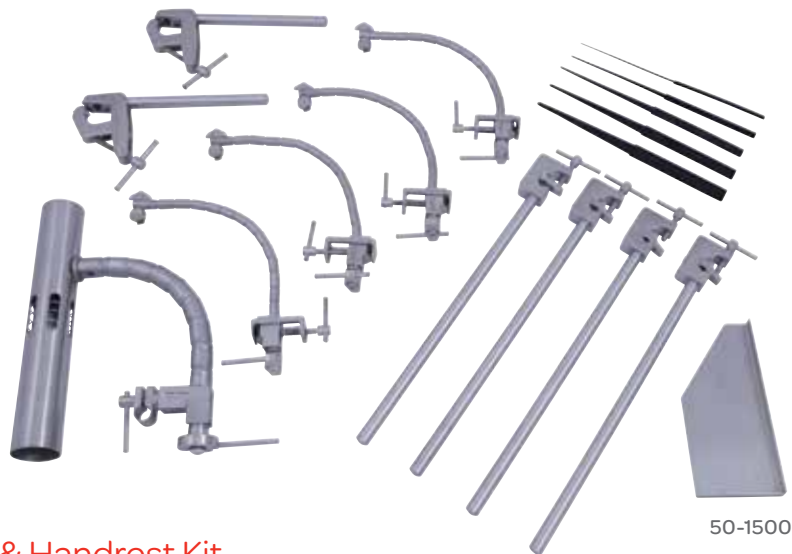

50-1500

Greenberg Universal Retractor & Handrest Kit

The Greenberg Retractor is a modular, self-retaining neurosurgical/microsurgical retractor system. The Greenberg system provides the surgeon increased control and support in dissection as well as reliable exposure in multiple planes of retraction. A variety of configurations are possible with a combination of component parts. Speak to your Symmetry Sales Representative for a more complete description of the possible retraction levels.

	CODE	DESCRIPTION	LENGTH		TAPERED BLADE WIDTH	QTY
	50-1500	Includes the Following:				
BARS	50-1507	Greenberg Primary Bar, Attaches to Skull Clamp	6 in	152 mm		2
	50-1508	Greenberg Secondary Bar, Attaches to Primary Bar	12 in	305 mm		4
ARM	50-1509	Greenberg Long Retractor Arm Attaches to primary or secondary bar	9 ½ in	241 mm		4
		Blades Mount onto Long Arm (50-1509) or Short Arm (50-1511)				
BLADES	50-1534	Greenberg Tapered Retractor Blade	¼ x ¼ in	1.6 x 19 mm	9 in	229 mm 1
	50-1533	Greenberg Tapered Retractor Blade	⅜ x ⅜ in	2 x 10 mm	9 in	229 mm 1
	50-1532	Greenberg Tapered Retractor Blade	⅛ x ½ in	3 x 13 mm	9 in	229 mm 1
	50-1531	Greenberg Tapered Retractor Blade	⅝ x ⅝ in	4 x 16 mm	9 in	229 mm 1
	50-1530	Greenberg Tapered Retractor Blade	¼ x ¾ in	6 x 19 mm	9 in	229 mm 1
HANDREST	50-1512	Greenberg Handrest Attaches to short coupler (50-1522) or a secondary bar (50-1508 or 50-1516)	10 in	254 mm		
PATTIE TRAY	50-1513	Greenberg Pattie Tray Attaches to Long or Short Arm (50-1509 or 50-1511)	3 in	76 mm	6 ¼ in	171 mm 1

Retractors (Greenberg)

Greenberg Universal Retractor & Handrest Kit (continued)

CODE	DESCRIPTION	WIDTH	DEPTH	LENGTH	QTY
50-1514	Greenberg Retractor Case - Includes Four Compartments for Various Components	10 in (254 mm)	2 1/8 in (60 mm)	17 in (432 mm)	1
Compartment Sizes:					
	Compartment # 1	7 3/4 in (197 mm)	10 3/4 in (264 mm)		
	Compartment # 2	2 1/8 in (54 mm)	17 in (432 mm)		
	Compartment # 3	4 5/8 in (117 mm)	6 3/4 in (171 mm)		
	Compartment # 4	3 1/8 in (79 mm)	6 3/4 in (171 mm)		

Greenberg Floating Secondary Bar

CODE	DESCRIPTION	LENGTH
50-1516	Attaches to Primary or Secondary Bar	12 in 304 mm



Greenberg Hand Rest

CODE	DESCRIPTION	LENGTH
50-1512	Attaches to Short Coupler (50-1509) or Secondary Bar (50-1508 or 50-1516)	10 in 254 mm



Retractors (Greenberg)

Greenberg Instrument Holder

Superior Retractor

CODE	DESCRIPTION
50-1523	Small, Holds Shafts Up to $\frac{5}{16}$ in (8.0 mm) Diameter and Flat Instruments



Greenberg Instrument Holder

Condylar Retractor

CODE	DESCRIPTION
50-1524	Large, Holds Shafts Up to 1 in (25 mm) Diameter



Greenberg Instrument Holder

CODE	DESCRIPTION
50-1525	Extra-Large, Holds Shafts up to 2 in (51 mm) Diameter



Greenberg Micro Instrument Holder Collateral Retractor

CODE	DESCRIPTION
50-1529	Flexbar Arm Used to Hold Microinstruments, Holds Up to $\frac{1}{8}$ in (3 mm) Diameter



Retractors (Greenberg)

Greenberg Long Arm

Patellar Retractor

CODE	DESCRIPTION
50-1509	Attaches to Primary or Secondary Bar

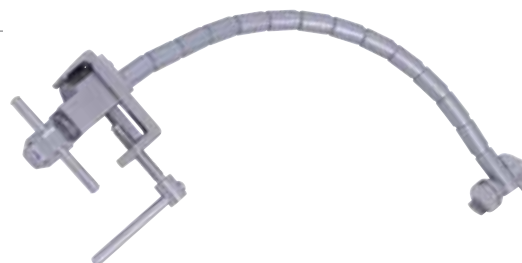

Greenberg Maxi-Vise Adapter

Double the holding diameter of arms from 4 mm to 8 mm

Useful for holding suction devices and other various microsurgical instruments

CODE	DESCRIPTION
50-1515	Attaches to the Greenberg Flexible Arms (50-1509 and 50-1511)



Greenberg Pattie Tray

CODE	DESCRIPTION	LENGTH
50-1513	Attaches to Long or Short Arm (50-1509 or 50-1511)	6¼in 171mm



Retractors (Greenberg)

Greenberg Style Ultra Cranial Pattie Tray

CODE	DESCRIPTION	LENGTH
59-7905	Titanium	6¼ in 171 mm



Greenberg Primary Bar

Malleable Retractor Blade

CODE	DESCRIPTION	LENGTH
50-1507	Attaches to Skull Clamp	6 in 152 mm



Greenberg Retractor Blade

Tapered

CODE	TAPERED BLADE WIDTH	BLADE LENGTH
50-1534	¼ x ¼ in	1.6 x 19 mm 9 in 229 mm
50-1533	⅜ x ⅜ in	2 x 10 mm 9 in 229 mm
50-1532	⅛ x ½ in	3 x 13 mm 9 in 229 mm
50-1531	⅝ x ⅝ in	4 x 16 mm 9 in 229 mm
50-1530	¼ x ¾ in	6 x 19 mm 9 in 229 mm



50-1530

Retractors (Greenberg)

Greenberg Secondary Bar

CODE	DESCRIPTION	LENGTH
50-1508	Attaches to Primary Bar	12 in 304 mm

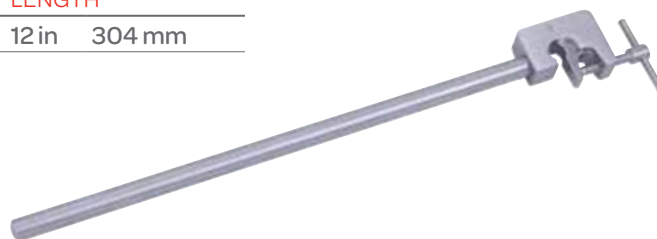

Greenberg Short Coupler

CODE	DESCRIPTION	LENGTH
50-1522	Can Be Used as Mount for the Greenberg Handrest	5½ in 140 mm



Greenberg Short Retractor Arm

CODE	DESCRIPTION	LENGTH
50-1511	Attaches to Primary Bar or Secondary Bar	6½ in 165 mm



Retractors (Greenberg)



Greenberg Sterilizing Case

Includes Four Compartments for Various Components

CODE	DESCRIPTION	WIDTH	DEPTH	LENGTH	QTY
50-1514	Universal Retractor Case	10 in (254 mm)	2 1/8 in (60 mm)	17 in (432 mm)	1
Compartment Sizes:					
	Compartment # 1	7 3/4 in (197 mm)	10 3/4 in (264 mm)		
	Compartment # 2	2 1/8 in (54 mm)	17 in (432 mm)		
	Compartment # 3	4 5/8 in (117 mm)	6 3/4 in (171 mm)		
	Compartment # 4	3 1/8 in (79 mm)	6 3/4 in (171 mm)		

Cushing Retractor

CODE	DESCRIPTION	JAW LENGTH	LENGTH
32-3633		10 mm	11 in 279 mm
32-3634		11 mm	14 in 356 mm



32-3633

Retractors (Hand-Held)

Oldberg Retractor

CODE	DESCRIPTION	JAW LENGTH	LENGTH
57-5253	3 Prong, 13 mm	8 ¼ in	210 mm
57-5254	4 Prong, 15 mm	8 ¼ in	210 mm



57-5253

Retractors (Jannetta)

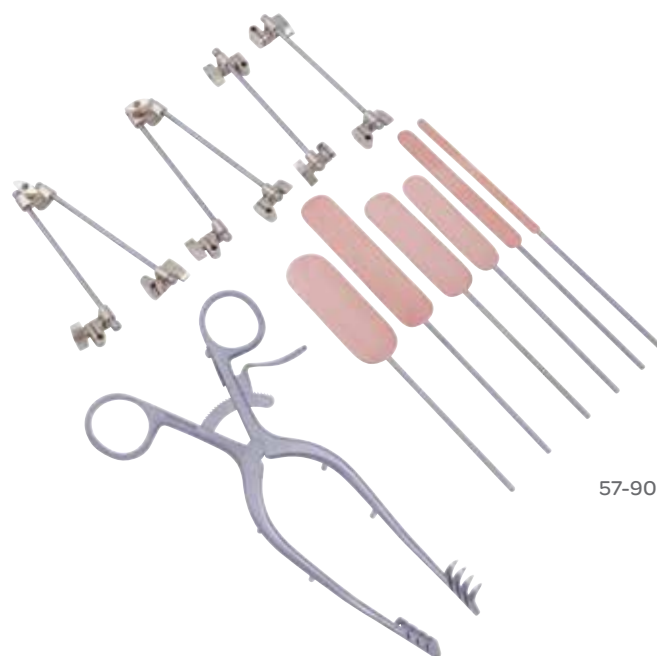

57-9000

Jannetta Posterior Fossa Retractor

CODE	DESCRIPTION	DETAIL	LENGTH
57-9000	Complete Set Includes:		
57-9024	Double Round Bar	3 Swivels	4 in 260 mm
57-9028	Malleable Retractor Blade	15 x 70 mm	6 ½ in 165 mm
57-9030	Malleable Retractor Blade	20 x 75 mm	6 ¾ in 171 mm
57-9032	Malleable Retractor Blade	25 x 75 mm	6 ¾ in 171 mm
57-9034	Malleable Retractor Blade	10 x 95 mm	7 ½ in 190 mm
57-9036	Malleable Retractor Blade	20 x 95 mm	7 ½ in 190 mm
57-9038	Malleable Retractor Blade	5 x 95 mm	7 ½ in 190 mm
57-9022	Retractor Body	With 4 Posts	
57-9026	Round Bar	With 2 Swivels	

Retractors (Leyla)

Leyla Brain Retractor

CODE	DESCRIPTION
57-5910	Flexible Tension Arm



Leyla Brain Retractor

CODE	DESCRIPTION
57-5941	Rigid Holding Arm



Leyla Brain Retractor

CODE	DESCRIPTION
57-5901	Set of 2, Self-Retaining, One-Armed



Leyla Brain Retractor

CODE	DESCRIPTION	WIDTH	LENGTH
57-5902	Set of 2, Self-Retaining, Two-Armed	$\frac{3}{8}$ in 10 mm	6 $\frac{3}{4}$ in 170 mm



Retractors (Leyla)

Leyla Brain Retractor

CODE	DESCRIPTION	LENGTH
57-5930	Spatula Support	7 in 178 mm



Leyla Brain Retractor

CODE	DESCRIPTION
57-5921	Fixation Base, For One Arm Only
57-5922	Fixation Base, For Double Arm



Leyla Brain Retractor

CODE	DESCRIPTION	WIDTH
57-5943	Ball Joint Clamp	1 in 26 mm



Leyla Brain Retractor

CODE	DESCRIPTION
57-5942	Coupling Head to Hold Flexible Arms



Retractors (Malis)



50-1460

Malis Brain Retractor Kit

Black Anodized, Attaches to the Malis Cerebellar Retractor (50-1465)

CODE	DESCRIPTION	QTY	LENGTH	WIDTH
50-1460	Includes one each of the five blades and three extensions listed below:			
	Blade	1	3 in 76 mm	$\frac{3}{8}$ in 10 mm
	Blade	1	3 in 76 mm	$\frac{9}{16}$ in 14 mm
	Blade	1	3 in 76 mm	$\frac{5}{8}$ in 16 mm
	Blade	1	3 in 76 mm	$\frac{3}{4}$ in 19 mm
	Blade	1	3 in 76 mm	$\frac{3}{8}$ in 10 mm
	Retractor Extension	1	2 in 51 mm	
	Retractor Extension	1	3 in 76 mm	
	Retractor Extension	1	4 in 102 mm	
50-1454	Double Connector	2		

Malis Cerebellar Retractor

4 x 4 Sharp Prongs, Self-Retaining, Angular Arms

CODE	DESCRIPTION	LENGTH
50-1465	Total Opening $5\frac{1}{2}$ in (140 mm), Post Height $1\frac{1}{2}$ in (38 mm), Prong Width $\frac{5}{8}$ in (16 mm), Prong Depth $\frac{7}{8}$ in (22 mm)	7 in 178 mm



Retractors (Malis)

Malis Connector

CODE	DESCRIPTION
50-1454	50-1460 Includes 2 of 50-1454



Malis Hinge Clamp

CODE	DESCRIPTION
50-1453	Hinge Clamp



Retractors (Scalp)

Anderson-Adson Scalp Retractor

Total Opening 4 ½ in (114 mm)

CODE	BLADE WIDTH	BLADE DEPTH	LENGTH
50-1186	¾ in 19 mm	⅝ in 16 mm	7½ in 191 mm



Retractors (Scalp)

Cone Scalp Retractor

Self-Retaining with Hinged Arms

CODE	DESCRIPTION	LENGTH
50-1166	3 x 4 Blunt Prongs	5 $\frac{3}{4}$ in 146 mm



Contour Scalp Retractor

Angled Arms, 15 mm deep

CODE	DESCRIPTION	LENGTH
24-2670	3 x 4 Blunt Prongs	5 $\frac{1}{2}$ in 140 mm
24-2671	3 x 4 Sharp Prongs	5 $\frac{1}{2}$ in 140 mm



24-2670

Jansen Scalp Retractor

CODE	DESCRIPTION	LENGTH
24-1310	3 x 3 Sharp Prongs	4 in 102 mm
24-1320	3 x 3 Blunt Prongs	4 in 102 mm
24-1321	4 x 4 Blunt Prongs	4 $\frac{3}{8}$ in 111 mm



24-1310

Retractors (Self-Retaining)

Adson Retractor

Total Opening 5 in (127 mm), Shank Angle 65°

CODE	DESCRIPTION	DIMENSIONS
50-1362	3 x 3 Sharp Prongs	5 x 9½ in 127 x 241 mm

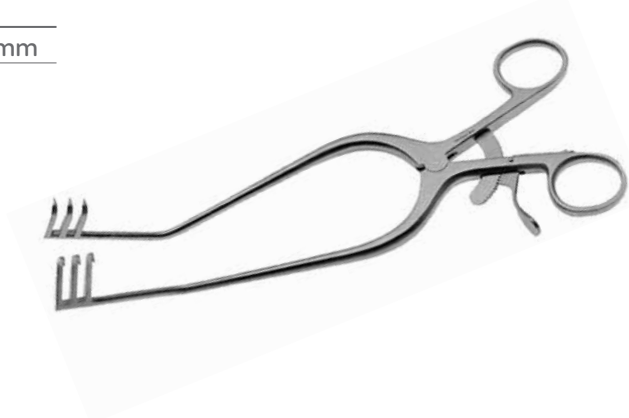

Alm Self-Retaining Retractor

CODE	DESCRIPTION	LENGTH
24-1007	4 x 4 Sharp Prongs	2¾ in 70 mm
24-1008	4 x 4 Blunt Prongs	2¾ in 70 mm
24-1011	4 x 4 Blunt Prongs	4 in 102 mm



24-1007

Retractors (Transsphenoidal)

Hardy Lip Retractor

CODE	DESCRIPTION
80-1337	Lip Retractor



Retractors (Vein)

Cushing Vein Retractor

CODE	TIP WIDTH	LENGTH	
20-1710	10 mm	8 in	203 mm
20-1712	12 mm	8 in	203 mm
20-1714	14 mm	8 in	203 mm
20-1718	18 mm	8 in	203 mm
20-1730	10 mm	9 ½ in	241 mm
20-1732	12 mm	9 ½ in	241 mm
20-1736	16 mm	9 ½ in	241 mm
20-1752	11 mm	14 in	356 mm



20-1710

Retractors (Vessel Supporter)

Malis Vessel Supporter

Titanium Handle, Stainless Steel Shaft

CODE	DESCRIPTION	LENGTH	
80-1534	Two Prong	7 ¾ in	187 mm



Williams Retractor

CODE	DESCRIPTION	DIMENSIONS
80-1650	Right	50 x 10 mm Right
80-1651	Right	50 x 20 mm
80-1652	Right	70 x 10 mm
80-1653	Right	70 x 20 mm
80-1650S	Left	50 x 10 mm
80-1651S	Left	50 x 20 mm
80-1652S	Left	70 x 10 mm
80-1653S	Left	70 x 20 mm



80-1650

Rongeurs (Bone)

Beyer Rongeur

CODE	DESCRIPTION	LENGTH	
53-1100	Curved, Double-Action	7 in	178 mm

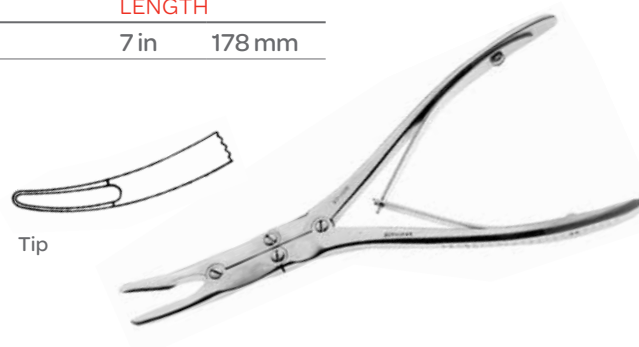

Friedman Bone Rongeur

Curved

CODE	DESCRIPTION	LENGTH	
30-0514	Delicate, 4.0 mm Wide	5 ½ in	140 mm
30-0516	4.0 x 11 mm	5 ½ in	140 mm

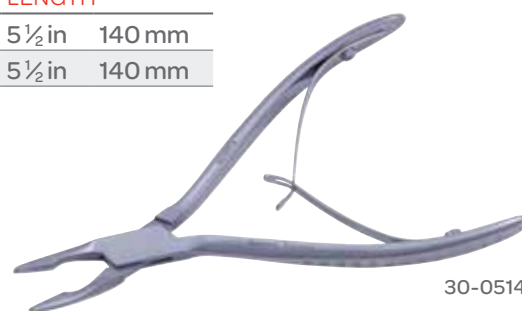

Lempert Rongeur

CODE	DESCRIPTION	JAWS	LENGTH	
53-1108	Straight	2.0 mm	6 ⅞ in	156 mm
53-1102	Curved	2.0 mm	6 ⅞ in	156 mm
30-7620	Straight, Slender Pattern	2.5 mm	6 ¼ in	159 mm
30-7623	Curved, Slender Pattern	2.5 mm	6 ½ in	165 mm
30-7619	Straight	2.5 mm	7 ½ in	191 mm
30-7624	Straight, Slender Pattern	2.5 mm	7 ½ in	191 mm
30-7625	Curved, Slender Pattern	2.5 mm	7 ½ in	191 mm

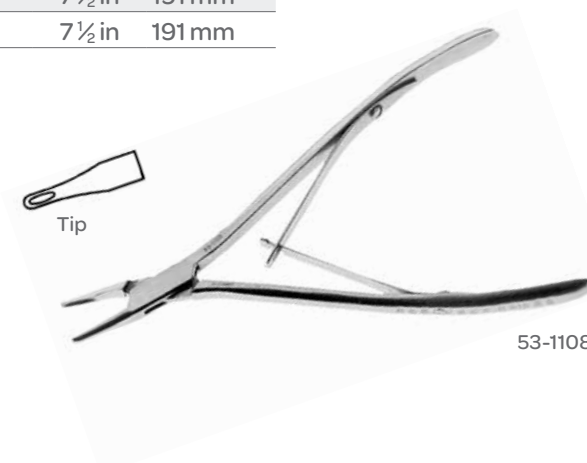

Rongeurs (Bone)

Luer Bone Rongeur

CODE	DESCRIPTION	BITE	LENGTH	
30-5217	Straight	8.0 mm	7 in	178 mm
53-1011	Curved	6.0 mm	7 in	178 mm

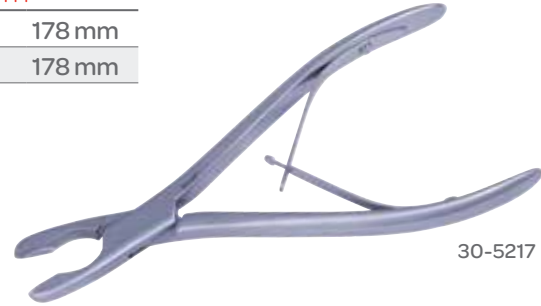

30-5217

Reiner Bone Rongeur

CODE	DESCRIPTION	BITE	LENGTH	
53-1015	Curved	3.0 x 13 mm	7 in	178 mm
53-1016	Curved	4.0 x 14 mm	7 in	178 mm

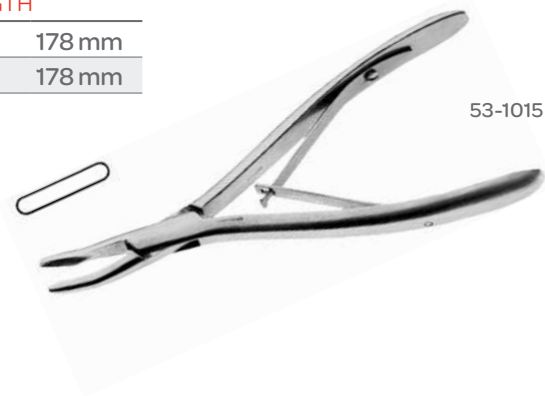

53-1015

Reiner Rongeur

CODE	DESCRIPTION	BITE	LENGTH	
30-7627	Rongeurs	4 mm	7 in	178 mm

Image Not Available



Rongeurs (Bone)

Ruskin Rongeur

Double-Action

CODE	DESCRIPTION	BITE	LENGTH
53-1310	Straight	4 mm	7¼ in 184 mm
53-1312	Straight	5 mm	7¼ in 184 mm
53-1311	Curved	4 mm	7¼ in 184 mm
53-1313	Curved	5 mm	7¼ in 184 mm



53-1310

Stille-Luer Rongeur

CODE	DESCRIPTION	BITE	LENGTH
53-1130	Straight	10 mm	8½ in 216 mm
53-1131	Curved	10 mm	8½ in 216 mm
53-1118	Angular, Flat Lower Jaw	5 mm	9½ in 241 mm
53-1133	Angular	5 mm	9½ in 241 mm
67-7239		5 mm	11 in 279 mm
67-7240		10 mm	11 in 279 mm



67-7240

Zaufal-Jansen Rongeur

CODE	DESCRIPTION	BITE	LENGTH
53-1095	Curved, Double-Action	4.0 x 30 mm	6¾ in 171 mm



Rongeurs (Cervical)

Black Diamond Micro Kerrison Rongeur

15 mm Opening

CODE	DESCRIPTION	BITE	LENGTH
57-0022-BD	40° Up	2 mm	8 in 203 mm
57-0023-BD	40° Up	3 mm	8 in 203 mm
57-0024-BD	40° Up	4 mm	8 in 203 mm
57-0025-BD	40° Up	5 mm	8 in 203 mm



57-0022-BD

Black Diamond Micro Kerrison Bayonet Rongeur

CODE	DESCRIPTION	BITE	LENGTH
56-1201-BD	90° Up	1 mm	6 in 160 mm
56-1202-BD	90° Up	2 mm	6 in 160 mm
56-1203-BD	90° Up	3 mm	6 in 160 mm
56-1204-BD	40° Up	4 mm	6 in 160 mm
56-1205-BD	40° Up	5 mm	6 in 160 mm

Image Not Available



Rongeurs (Cervical)

Black Diamond Micro Kerrison Rongeur

Thin Footplate

CODE	DESCRIPTION	BITE	LENGTH
57-0721-BD	40° Up	1 mm	7 in 178 mm
57-0722-BD	40° Up	2 mm	7 in 178 mm
57-0723-BD	40° Up	3 mm	7 in 178 mm
57-0724-BD	40° Up	4 mm	7 in 178 mm
57-0725-BD	40° Up	5 mm	7 in 178 mm
57-0726-BD	40° Up	6 mm	7 in 178 mm
57-0701-BD	90° Up	1 mm	7 in 178 mm
57-0702-BD	90° Up	2 mm	7 in 178 mm
57-0703-BD	90° Up	3 mm	7 in 178 mm
57-0704-BD	90° Up	4 mm	7 in 178 mm
57-0705-BD	90° Up	5 mm	7 in 178 mm
57-0761-BD	40° Up	1 mm	8 in 203 mm
57-0762-BD	40° Up	2 mm	8 in 203 mm
57-0763-BD	40° Up	3 mm	8 in 203 mm
57-0764-BD	40° Up	4 mm	8 in 203 mm
57-0765-BD	40° Up	5 mm	8 in 203 mm
57-0766-BD	40° Up	6 mm	8 in 203 mm
57-0739-BD	90° Up	1 mm	8 in 203 mm
57-0740-BD	90° Up	2 mm	8 in 203 mm
57-0743-BD	90° Up	3 mm	8 in 203 mm
57-0744-BD	90° Up	4 mm	8 in 203 mm
57-0891-BD	40° Up	1 mm	9 in 228 mm
57-0892-BD	40° Up	2 mm	9 in 228 mm
57-0893-BD	40° Up	3 mm	9 in 228 mm
57-0894-BD	40° Up	4 mm	9 in 228 mm
57-0895-BD	40° Up	5 mm	9 in 228 mm
57-0896-BD	40° Up	6 mm	9 in 228 mm



Rongeurs (Cervical)

Black Diamond Micro Kerrison Rongeur

Thin Footplate

CODE	DESCRIPTION	BITE	LENGTH
57-0801-BD	40° Down	1 mm	8 in 203 mm
57-0802-BD	40° Down	2 mm	8 in 203 mm
57-0803-BD	40° Down	3 mm	8 in 203 mm
57-0804-BD	40° Down	4 mm	8 in 203 mm
57-0751-BD	90° Down	1 mm	8 in 203 mm
57-0750-BD	90° Down	2 mm	8 in 203 mm
57-0752-BD	90° Down	3 mm	8 in 203 mm
57-0754-BD	90° Down	4 mm	8 in 203 mm

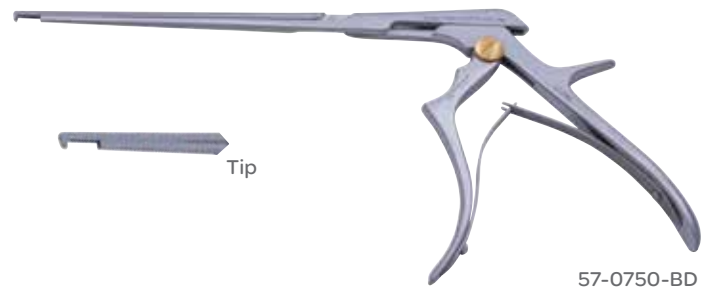

Black Diamond Micro Kerrison Rongeur With Ejector

9 mm Opening

CODE	DESCRIPTION	BITE	LENGTH
57-0392-BD	40° Up	2 mm	7 in 178 mm
57-0393-BD	40° Up	3 mm	7 in 178 mm
57-0394-BD	40° Up	4 mm	7 in 178 mm
57-0395-BD	40° Up	5 mm	7 in 178 mm
57-0692-BD	40° Up	2 mm	8 in 203 mm
57-0693-BD	40° Up	3 mm	8 in 203 mm
57-0694-BD	40° Up	4 mm	8 in 203 mm
57-0695-BD	40° Up	5 mm	8 in 203 mm
57-0696-BD	40° Up	6 mm	8 in 203 mm



Rongeurs (Cervical)

Black Diamond Pituitary Bayonet Rongeur

CODE	DESCRIPTION	BITE	LENGTH
56-2112-BD	Straight, 2 x 8 mm	1 mm	6 in 160 mm
56-2114-BD	Straight, 4 x 10 mm	2 mm	6 in 160 mm
56-2116-BD	Angled Up, 2 x 8 mm	3 mm	6 in 160 mm



Black Diamond Spurling Kerrison Rongeur

15 mm Opening

CODE	DESCRIPTION	BITE	LENGTH
57-0582-BD	40° Up	2 mm	8 in 203 mm
57-0583-BD	40° Up	3 mm	8 in 203 mm
57-0584-BD	40° Up	4 mm	8 in 203 mm
57-0585-BD	40° Up	5 mm	8 in 203 mm

Image Not Available



Caspar IVD Rongeur

CODE	DESCRIPTION	BITE	JAWS
57-2912	Straight	2 x 12 mm	6 ¼ in 159 mm
57-2913	Straight	3 x 12 mm	6 ¼ in 159 mm
57-2915	Straight	5 x 12 mm	6 ¼ in 159 mm
57-2901	Straight	2 x 12 mm	7 ¼ in 184 mm
57-2902	Straight	3 x 12 mm	7 ¼ in 184 mm
57-2903	Straight	4 x 12 mm	7 ¼ in 184 mm
57-2904	Straight	5 x 12 mm	7 ¼ in 184 mm



Rongeurs (Cervical)

Caspar Rongeur

CODE	DESCRIPTION	BITE	LENGTH
57-2946	Down	3 mm	6 in 152 mm
57-2919	Angled Up	5 x 14 mm	6¼ in 159 mm
57-2921	Angled Down	4 x 14 mm	6¼ in 159 mm
57-2905	Angled Up	3 x 12 mm	7½ in 190 mm
57-2910	Up	2 x 12 mm	7¼ in 184 mm
57-2920-1	Angled Down	2 x 12 mm	7¼ in 184 mm
57-2906	Angled Up	4 x 14 mm	7½ in 190 mm
57-2908	Angled Down	5 x 14 mm	7½ in 190 mm

Image Not Available



Caspar Rongeur

Black Diamond

CODE	DESCRIPTION	BITE	LENGTH
57-2901-BD	Straight	2 x 12 mm	7¼ in 184 mm
57-2903-BD	Straight	4 x 14 mm	7¼ in 184 mm
57-2922-BD	Straight	2 x 12 mm	9 in 228 mm
57-2930-BD	Down	2 x 12 mm	9 in 228 mm



Classic Thin Footplate Cervical Rongeur

Thin Footplate

CODE	DESCRIPTION	BITE	LENGTH
53-1537	Angle 40° Up	1.0 mm	
53-1539	Angle 40° Up	1.0 mm	
53-1500C	Angle 40° Up	2.0 mm	6 in 152 mm
53-1503	Angle 40° Up	3.0 mm	6 in 152 mm
53-1506	Angle 40° Up	4.0 mm	6 in 152 mm
53-1509	Angle 40° Up	5.0 mm	6 in 152 mm
53-1512	Angle 40° Up	2.0 mm	7 in 178 mm
53-1515	Angle 40° Up	3.0 mm	7 in 178 mm
53-1518	Angle 40° Up	4.0 mm	7 in 178 mm
53-1521	Angle 40° Up	5.0 mm	7 in 178 mm
53-1524	Angle 40° Up	2.0 mm	8 in 203 mm
53-1527	Angle 40° Up	3.0 mm	8 in 203 mm
53-1530	Angle 40° Up	4.0 mm	8 in 203 mm
53-1533	Angle 40° Up	5.0 mm	8 in 203 mm

Image Not Available



Rongeurs (Cervical)

Classic Thin Footplate Cervical Rongeur

Thin footplate designed to easily fit under the cervical lamina. Gold screw for easy identification of thin footplate. Bite size is identified below gold screw. Hardy style handle with ball spring.

CODE	DESCRIPTION	BITE	LENGTH
53-1501	Angle 90° Up	2.0 mm	6 in 152 mm
53-1504	Angle 90° Up	3.0 mm	6 in 152 mm
53-1507	Angle 90° Up	4.0 mm	6 in 152 mm
53-1510	Angle 90° Up	5.0 mm	6 in 152 mm
53-1502	Angle 90° Down	2.0 mm	6 in 152 mm
53-1505	Angle 90° Down	3.0 mm	6 in 152 mm
53-1508	Angle 90° Down	4.0 mm	6 in 152 mm
53-1511	Angle 90° Down	5.0 mm	6 in 152 mm
53-1513	Angle 90° Up	2.0 mm	7 in 178 mm
53-1516	Angle 90° Up	3.0 mm	7 in 178 mm
53-1519	Angle 90° Up	4.0 mm	7 in 178 mm
53-1522	Angle 90° Up	5.0 mm	7 in 178 mm
53-1514	Angle 90° Down	2.0 mm	7 in 17.8 cm
53-1517	Angle 90° Down	3.0 mm	7 in 17.8 cm
53-1520	Angle 90° Down	4.0 mm	7 in 17.8 cm
53-1523	Angle 90° Down	5.0 mm	7 in 17.8 cm
53-1525	Angle 90° Up	2.0 mm	8 in 203 mm
53-1528	Angle 90° Up	3.0 mm	8 in 203 mm
53-1531	Angle 90° Up	5.0 mm	8 in 203 mm
53-1534	Angle 90° Up	5.0 mm	8 in 203 mm
53-1526	Angle 90° Down	2.0 mm	8 in 203 mm
53-1529	Angle 90° Down	3.0 mm	8 in 203 mm
53-1532	Angle 90° Down	4.0 mm	8 in 203 mm
53-1535	Angle 90° Down	5.0 mm	8 in 203 mm

Image Not Available



Cloward-Style Rongeur

CODE	DESCRIPTION	BITE	LENGTH
57-2456	Angled Up, Serrated	4 x 10 mm	6 in 152 mm

Image Not Available



Rongeurs (Cervical)

Cushing IVD Rongeur

CODE	DESCRIPTION	BITE	LENGTH
57-2002	Straight	2 x 10 mm	5 in 127 mm
57-2032	Angled Up	2 x 10 mm	5 in 127 mm
57-2062	Angled Down	2 x 10 mm	5 in 127 mm
57-2012	Straight	2 x 10 mm	6 in 152 mm
57-2042	Angled Up	2 x 10 mm	6 in 152 mm
57-2022	Straight	2 x 10 mm	7 in 178 mm
57-2122	Straight, With Teeth	2 x 10 mm	7 in 178 mm
57-2052	Angled Up	2 x 10 mm	7 in 178 mm
57-2152	Angled Up, With Teeth	2 x 10 mm	7 in 178 mm
57-2082	Angled Down	2 x 10 mm	7 in 178 mm
57-2182	Angled Down, With Teeth	2 x 10 mm	7 in 178 mm
57-2060	Straight	2 x 10 mm	9 in 229 mm
57-2063	Angled Up	2 x 10 mm	9 in 229 mm
57-2065	Angled Down	2 x 10 mm	9 in 229 mm

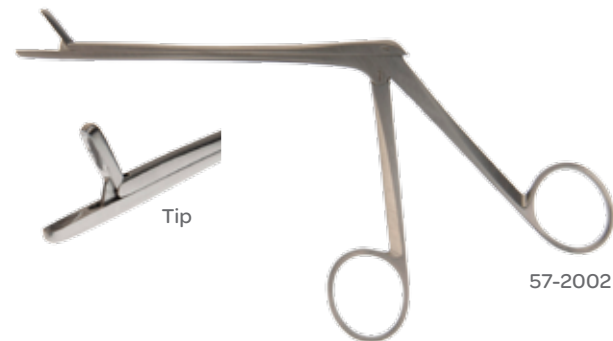

57-2002

Cushing Rongeur Delicate

CODE	DESCRIPTION	BITE	LENGTH
57-2000	Up	1.5 mm	7 in 178 mm
57-1999	Down	1.5 mm	7 in 178 mm
57-2001	Straight	1.5 mm	7 in 178 mm
57-1997	Up	1.5 mm	9 in 229 mm
57-1998	Straight	1.5 mm	9 in 229 mm

Image Not Available



Decker Rongeur

CODE	DESCRIPTION	LENGTH
57-2097	Angled up, 1.5 x 5 mm Cups	5 ½ in 138 mm
57-2098	Straight, 1.5 x 5 mm Cups	5 ½ in 138 mm
57-2099	Angled Down, 1.5 x 5 mm Cups	5 ½ in 138 mm
57-2100	Curved Left, 1.5 x 5 mm Cups	5 ½ in 138 mm

Image Not Available



Rongeurs (Cervical)

Del IVD Rongeur

CODE	DESCRIPTION	BITE	LENGTH	
57-2330	Straight	3 x 10 mm	6 in	152 mm
57-2331	Angled Up	3 x 10 mm	6 in	152 mm
57-2332	Down	3 x 10 mm	6 in	152 mm

Image Not Available



Detachable Cervical Rongeur

CODE	DESCRIPTION	BITE	LENGTH	
53-1544	Angle 40° Up	3.0 mm	7 in	178 mm
53-1546	Angle 40° Up	4.0 mm	7 in	178 mm

Image Not Available



Ferris Smith Kerrison Rongeur

Down Biting

CODE	DESCRIPTION	BITE	LENGTH	
57-1011		1 mm	7 in	178 mm
57-1020	40° Up	2 mm	7 in	178 mm

Image Not Available



Ferris Smith IVD Rongeur

CODE	DESCRIPTION	BITE	LENGTH	
57-1015	40° Up	5 mm	7 in	178 mm
57-1035	90° Down	5 mm	7 in	178 mm

Image Not Available



Ferris-Smith IVD Rongeur

CODE	DESCRIPTION	BITE	LENGTH	
57-1320	Up	2 x 10 mm	7 in	178 mm
57-1330	Up	3 x 10 mm	7 in	178 mm
57-1340	Up	4 x 10 mm	7 in	178 mm
57-1420	Down	2 x 10 mm	7 in	178 mm
57-1430	Down	3 x 10 mm	7 in	178 mm
57-1440	Down	4 x 10 mm	7 in	178 mm

Image Not Available



Rongeurs (Cervical)

Ferris-Smith Spurling IVD Rongeur

CODE	DESCRIPTION	BITE	LENGTH
57-1219	Straight	4 x 8 mm	7 in 178 mm
57-1220	Straight	2 x 10 mm	7 in 178 mm
57-1230	Straight	3 x 10 mm	7 in 178 mm
57-1240	Straight	4 x 10 mm	7 in 178 mm
57-1260	Straight	6 x 10 mm	7 in 178 mm

Image Not Available



Hoehn IVD Rongeur

CODE	DESCRIPTION	BITE	LENGTH
57-2450	Fenestrated, 1 x 2 Teeth	4 mm	5½ in 138 mm
57-2095	Straight, 1 x 2 Teeth	4 mm	5½ in 138 mm

Image Not Available



Kerrison Rongeur

CODE	DESCRIPTION	BITE	LENGTH
57-1100	Curved Up	2 mm	8 in 203 mm
57-1102	Curved Up	3 mm	8 in 203 mm
57-1104	Curved Up	4 mm	8 in 203 mm
57-1105	Curved Up	5 mm	8 in 203 mm



Rongeurs (Cervical)

Love-Gruenwald IVD Rongeur

CODE	DESCRIPTION	BITE	LENGTH
57-2013	Up	3 x 10 mm	6 in 152 mm
57-2014	Down	3 x 10 mm	6 in 152 mm
57-2066	Straight, With Teeth	3 x 10 mm	7 in 178 mm
57-2070	Straight	3 x 10 mm	9 in 229 mm
57-2073	Angled Up	3 x 10 mm	9 in 229 mm
57-2075	Angled Down	3 x 10 mm	9 in 229 mm

Image Not Available



Love Gruenwald IVD Rongeur

CODE	DESCRIPTION	BITE	LENGTH
57-2103	Straight	3 x 10 mm	5 in 127 mm
57-2133	Angled Up	3 x 10 mm	5 in 127 mm
57-2163	Angled Down	3 x 10 mm	5 in 127 mm
57-2123	Straight	3 x 10 mm	7 in 178 mm
57-2153	Angled Up	3 x 10 mm	7 in 178 mm
57-2183	Angled Down	3 x 10 mm	7 in 178 mm

Image Not Available



Micro Kerrison Bayonet Rongeur

CODE	DESCRIPTION	BITE	LENGTH
56-1001-BD	40° Up	1 mm	6 in 160 mm
56-1002-BD	40° Up	2 mm	6 in 160 mm
56-1003-BD	40° Up	3 mm	6 in 160 mm
56-1004-BD	40° Up	4 mm	6 in 160 mm
56-1005-BD	40° Up	5 mm	6 in 160 mm
56-1032	40° Up, Right	2 mm	7 in 180 mm
56-1033	40° Up, Right	3 mm	7 in 180 mm

Image Not Available



Rongeurs (Cervical)

Micro Kerrison Ejector Rongeur

9 mm Opening

CODE	DESCRIPTION	BITE	LENGTH
57-0692	40°	2 mm	8 in 203 mm
57-0693	40°	3 mm	8 in 203 mm
57-0694	40°	4 mm	8 in 203 mm
57-0695	40°	5 mm	8 in 203 mm
57-0696	40°	6 mm	8 in 203 mm



Micro Kerrison Rongeur

9 mm Opening, With Ejector-Thin Footplate

CODE	DESCRIPTION	BITE	LENGTH
57-0392	40° Up	2 mm	7 in 178 mm
57-0393	40° Up	3 mm	7 in 178 mm
57-0394	40° Up	4 mm	7 in 178 mm
57-0395	40° Up	5 mm	7 in 178 mm

Image Not Available



Micro Kerrison T-Bar Ejector Rongeur

9 mm Opening, Small Handle

CODE	DESCRIPTION	BITE	LENGTH
57-0852	40° Up	2.5 mm	8 in 203 mm
57-0853	40° Up	3 mm	8 in 203 mm
57-0854	40° Up	4 mm	8 in 203 mm
57-0855	40° Up	5 mm	8 in 203 mm

Image Not Available



Rongeurs (Cervical)

Micro Kerrison Rongeur

15 mm Opening, Gold Screw

CODE	DESCRIPTION	BITE	LENGTH
57-0763.15	40° Up	3 mm	8 in 203 mm
57-0764.15	40° Up	4 mm	8 in 203 mm
57-0765.15	40° Up	5 mm	8 in 203 mm

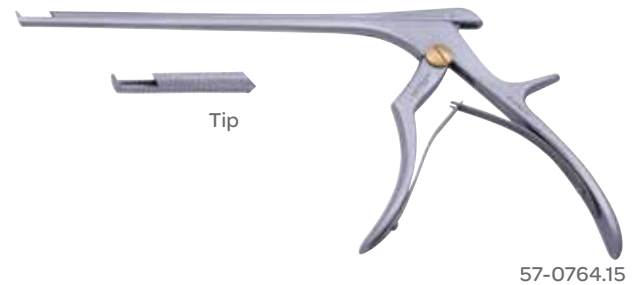

Micro Kerrison Rongeur

15 mm Opening, Small Handle

CODE	DESCRIPTION	BITE	LENGTH
57-0022	40° Up	2 mm	8 in 203 mm
57-0023	40° Up	3 mm	8 in 203 mm
57-0024	40° Up	4 mm	8 in 203 mm
57-0025	40° Up	5 mm	8 in 203 mm



Micro Kerrison Rongeur

15 mm Opening, Small Opening, Ultra Coat

CODE	DESCRIPTION	BITE	LENGTH
57-0022UC	40° Up	2 mm	8 in 203 mm
57-0024UC	40° Up	4 mm	8 in 203 mm

Image Not Available



Rongeurs (Cervical)

Micro Kerrison Rongeur

Thin Footplate

CODE	DESCRIPTION	BITE	LENGTH
57-0603	40° Up	3 mm	6 in 160 mm
57-0604	40° Up	4 mm	6 in 160 mm
57-0605	40° Up	3 mm	6 in 160 mm
57-0721	40° Up	1 mm	7 in 178 mm
57-0722	40° Up	2 mm	7 in 178 mm
57-0723	40° Up	3 mm	7 in 178 mm
57-0724	40° Up	4 mm	7 in 178 mm
57-0725	40° Up	5 mm	7 in 178 mm
57-0701	90° Up	1 mm	7 in 178 mm
57-0702	90° Up	2 mm	7 in 178 mm
57-0703	90° Up	3 mm	7 in 178 mm
57-0704	90° Up	4 mm	7 in 178 mm
57-0705	90° Up	5 mm	7 in 178 mm
57-0761	40° Up	1 mm	8 in 203 mm
57-0762	40° Up	2 mm	8 in 203 mm
57-0763	40° Up	3 mm	8 in 203 mm
57-0764	40° Up	4 mm	8 in 203 mm
57-0765	40° Up	5 mm	8 in 203 mm
57-0766	40° Up	6 mm	8 in 203 mm
57-0739	90° Up	1 mm	8 in 203 mm
57-0740	90° Up	2 mm	8 in 203 mm
57-0743	90° Up	3 mm	8 in 203 mm
57-0744	90° Up	4 mm	8 in 203 mm
57-0745	90° Up	5 mm	8 in 203 mm
57-0746	90° Up	6 mm	8 in 203 mm
57-0891	40° Up	1 mm	9 in 228 mm
57-0892	40° Up	2 mm	9 in 228 mm
57-0893	40° Up	3 mm	9 in 228 mm
57-0894	40° Up	4 mm	9 in 228 mm
57-0895	40° Up	5 mm	9 in 228 mm
57-0896	40° Up	6 mm	9 in 228 mm
57-0901	90° Up	1 mm	9 in 228 mm
57-0902	90° Up	2 mm	9 in 228 mm
57-0903	90° Up	3 mm	9 in 228 mm
57-0905	90° Up	5 mm	9 in 228 mm
57-0101	40° Up	1 mm	10 in 254 mm
57-0102	40° Up	2 mm	10 in 254 mm
57-0103	40° Up	3 mm	10 in 254 mm
57-0104	40° Up	4 mm	10 in 254 mm
57-0105	40° Up	5 mm	10 in 254 mm



57-0603



Tip

Rongeurs (Cervical)

Micro Kerrison Rongeur

Thin Footplate

CODE	DESCRIPTION	BITE	LENGTH
57-0712	90° Down	2 mm	7 in 178 mm
57-0713	90° Down	3 mm	7 in 178 mm
57-0714	90° Down	4 mm	7 in 178 mm
57-0750	90° Down	2 mm	8 in 203 mm
57-0752	90° Down	3 mm	8 in 203 mm
57-0754	90° Down	4 mm	8 in 203 mm
57-0755	90° Down	5 mm	8 in 203 mm
57-0756	90° Down	6 mm	8 in 203 mm

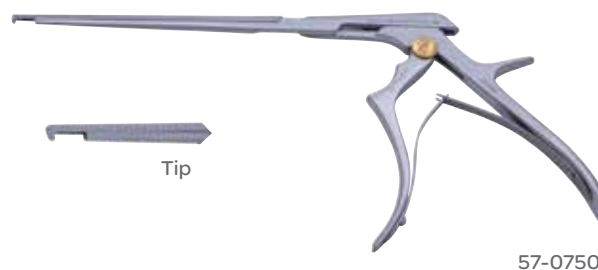

Micro Kerrison Rongeur

Ultra Coat

CODE	DESCRIPTION	BITE	LENGTH
57-0761UC	40° Up	1 mm	8 in 203 mm
57-0762UC	40° Up	2 mm	8 in 203 mm
57-0763UC	40° Up	3 mm	8 in 203 mm
57-0764UC	40° Up	4 mm	8 in 203 mm
57-0765UC	40° Up	5 mm	8 in 203 mm
57-0892UC	40° Up	2 mm	9 in 228 mm
57-0893UC	40° Up	3 mm	9 in 228 mm
57-0894UC	40° Up	4 mm	9 in 228 mm
57-0895UC	40° Up	5 mm	9 in 228 mm



Oldberg Rongeur

CODE	DESCRIPTION	CUP	LENGTH
57-2296		6 mm	7 in 178 mm

Image Not Available

Peapod IVD Rongeur

CODE	DESCRIPTION	BITE	LENGTH
57-2090	Angled Up	2.5 mm	5½ in 138 mm
57-2092	Angled Up	3 mm	5½ in 138 mm
57-2094	Angled Up	4 mm	5½ in 138 mm

Image Not Available

Rongeurs (Cervical)

RapidClean Detachable Cervical Kerrison Rongeur

CODE	DESCRIPTION	BITE	LENGTH
531540CD	Detachable, 40° Up	1 mm	7 in 180 mm
531542CD	Detachable, 40° Up	2 mm	7 in 180 mm
531544CD	Detachable, 40° Up	3 mm	7 in 180 mm
531546CD	Detachable, 40° Up	4 mm	7 in 180 mm
531570CD	Detachable, 40° Up	1 mm	8 in 200 mm
531572CD	Detachable, 40° Up	2 mm	8 in 200 mm
531574CD	Detachable, 40° Up	3 mm	8 in 200 mm
531576CD	Detachable, 40° Up	4 mm	8 in 200 mm
531548CD	Detachable, 40° Up	1 mm	9 in 230 mm
531550CD	Detachable, 40° Up	2 mm	9 in 230 mm
531552CD	Detachable, 40° Up	3 mm	9 in 230 mm
531554CD	Detachable, 40° Up	4 mm	9 in 230 mm

Image Not Available



Schlesinger IVD Rongeur

CODE	DESCRIPTION	BITE	LENGTH
57-2435	Angled Up	3 x 10 mm	5 in 127 mm
57-2432	Straight	2 x 10 mm	6 in 152 mm
57-2433	Straight	3 x 10 mm	6 in 152 mm
57-2434	Straight	4 x 10 mm	6 in 152 mm

Image Not Available



Selverstone IVD Rongeur

CODE	DESCRIPTION	LENGTH
57-1255	2 x 3 mm Cup	6 in 152 mm
57-1262	2 x 3 mm Cup	6 in 152 mm

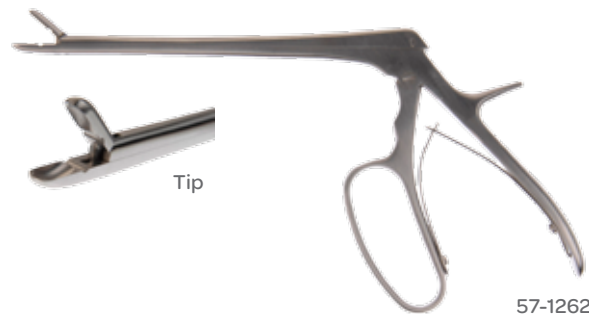

57-1262

Spurling IVD Rongeur

with Teeth

CODE	DESCRIPTION	BITE	LENGTH
57-2300	Straight	4 x 10 mm	7 in 178 mm
57-2301	Angled Up	4 x 10 mm	7 in 178 mm
57-2302	Angled Down	4 x 10 mm	7 in 178 mm

Image Not Available



Rongeurs (Cervical)

Spurling Kerrison Rongeur

Ultra Coat

CODE	DESCRIPTION	BITE	LENGTH
57-0582UC	40° Up	2 mm	8 in 203 mm
57-0583UC	40° Up	3 mm	8 in 203 mm
57-0584UC	40° Up	4 mm	8 in 203 mm
57-0585UC	40° Up	5 mm	8 in 203 mm

Image Not Available



Spurling Kerrison Rongeur

15 mm Opening, Large Handle

CODE	DESCRIPTION	BITE	LENGTH
57-0543	90° Down	5 mm	7 in 178 mm
57-0203	90° Up	3 mm	6 in 160 mm
57-0544	90° Down	3 mm	6 in 160 mm
57-0545	90° Down	4 mm	6 in 160 mm
57-0552	40° Up	2 mm	7 in 178 mm
57-0553	40° Up	3 mm	7 in 178 mm
57-0554	40° Up	4 mm	7 in 178 mm
57-0556	40° Up	6 mm	7 in 178 mm
57-0533	90° Up	3 mm	7 in 178 mm
57-0534	90° Up	4 mm	7 in 178 mm
57-0535	90° Up	5 mm	7 in 178 mm
57-0536	90° Up	6 mm	7 in 178 mm
57-0582	40° Up	2 mm	8 in 203 mm
57-0583	40° Up	3 mm	8 in 203 mm
57-0584	40° Up	4 mm	8 in 203 mm
57-0585	40° Up	5 mm	8 in 203 mm
57-0586	40° Up	6 mm	8 in 203 mm
57-0562	90° Up	2 mm	8 in 203 mm
57-0563	90° Up	3 mm	8 in 203 mm
57-0565	90° Up	4 mm	8 in 203 mm
57-0782	40° Up	2 mm	9 in 228 mm
57-0783	40° Up	3 mm	9 in 228 mm
57-0784	40° Up	4 mm	9 in 228 mm
57-0785	40° Up	5 mm	9 in 228 mm
57-0786	40° Up	6 mm	9 in 228 mm

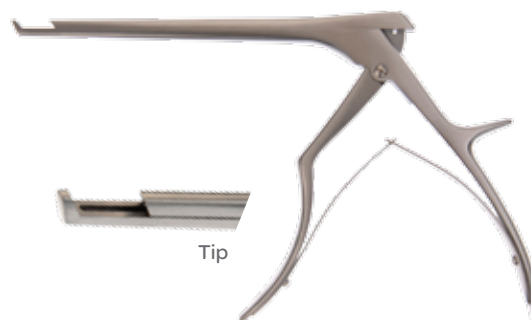

57-0554

Rongeurs (Cervical)

Spurling Kerrison Rongeur

CODE	DESCRIPTION	BITE	LENGTH
57-2204	Straight	4 x 10 mm	5 in 127 mm
57-2214	Straight	4 x 10 mm	6 in 152 mm
57-2244	Angled Up	4 x 10 mm	6 in 152 mm
57-2274	Angled Down	4 x 10 mm	6 in 152 mm
57-2224	Straight	4 x 10 mm	7 in 178 mm
57-2254	Angled Up	4 x 10 mm <td 7 in 178 mm	
57-2284	Angled Down	4 x 10 mm	7 in 178 mm
57-2270	Straight	4 x 10 mm	9 in 228 mm
57-2273	Angled Up	4 x 10 mm	9 in 228 mm
57-2275	Angled Down	4 x 10 mm	9 in 228 mm



57-2224

Wilde IVD Rongeur Micropak

Fenestrated Jaw

CODE	DESCRIPTION	BITE	LENGTH
57-2461	Straight	3 mm	5½ in 140 mm
57-2473	Straight	5 mm	7 in 178 mm
57-2477	Angled Up	4 mm	7 in 178 mm
57-2493	Straight	5 mm	9 in 228 mm

Image Not Available



Williams Discectomy IVD Rongeur

CODE	DESCRIPTION	LENGTH
57-2091	Up	5½ in 140 mm



Rongeurs (Cranial)

Adson Cranial Rongeur

CODE	DESCRIPTION	BITE	LENGTH
53-1040	Straight	8 mm	8 in 203 mm
30-5421	Straight	8 mm	8 ¼ in 210 mm
30-5423	Curved, 7.7 x 14 mm Cup	8 mm	8 ¼ in 210 mm



Bacon Cranial Rongeur

CODE	DESCRIPTION	BITE	LENGTH
53-1035	Angular	⅜ in 5 mm	8 ¼ in 210 mm

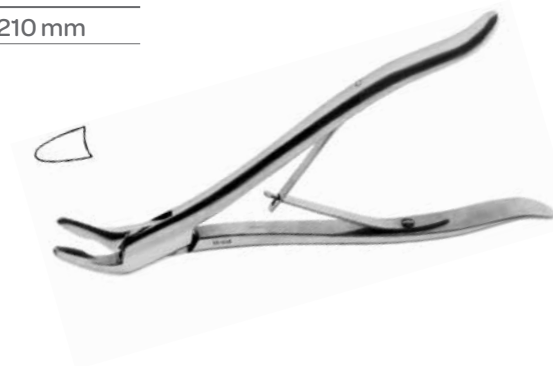

Stookey Cranial Rongeur

CODE	DESCRIPTION	BITE	LENGTH
53-1055	Angular	3 mm	8 ¼ in 210 mm

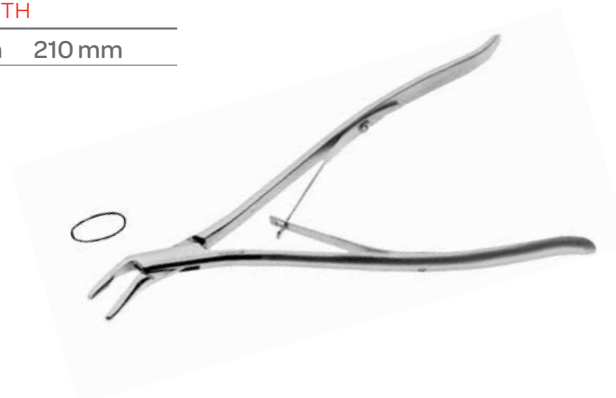

Rongeurs (Laminectomy)

Echlin Laminectomy Rongeur

Double-Action

CODE	DESCRIPTION	BITE	LENGTH
53-1046	Angular	3 mm	8¾ in 222 mm
53-1047	Angular	4 mm	8¾ in 222 mm

Image Not Available



Fulton Laminectomy Rongeur

Narrow Blade, Double-Action, Cup Size 15 x 16 mm

CODE	DESCRIPTION	LENGTH
53-1060	Straight	7½ in 191 mm
53-1061	Slightly Curved	7½ in 191 mm
53-1066	Straight	9½ in 241 mm



Leksell Laminectomy Rongeur

Double-Action

CODE	DESCRIPTION	BITE	LENGTH
53-1127	Regular Curve, Narrow Jaw	5 mm	9 in 229 mm
53-1125	Regular Curve, Wide Jaw	8 mm	9 in 229 mm
53-1128	Full Curve, Narrow Jaw	5 mm	9 in 229 mm
53-1126	Full Curve, Wide Jaw	8 mm	9 in 229 mm

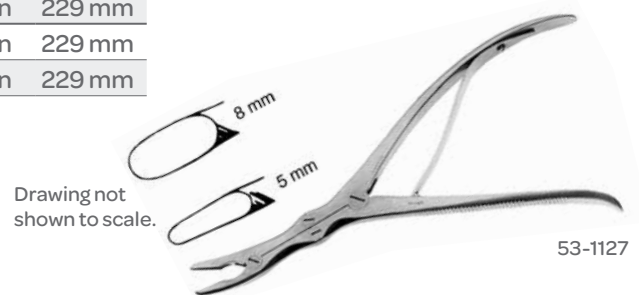

Leksell Rongeur

CODE	DESCRIPTION	BITE	LENGTH
67-7913	Full Curve	2 mm	14 in 356 mm
67-7914	Full Curve	3 mm	14 in 356 mm
67-7915	Full Curve	4 mm	14 in 356 mm
67-7916	Full Curve	5 mm	14 in 356 mm
67-7917	Full Curve	6 mm	14 in 356 mm



Rongeurs (Laminectomy)

Lempert Rongeur

CODE	DESCRIPTION	LENGTH
30-7622	Curved, Slender Pattern	6 ¼ in 159 mm

Image Not Available

MicroSect Shavers

CODE	DESCRIPTION	SHAFT
47-5030	45° Up 1.5 mm	8 ½ in 216 mm
47-5031	45° Up 2.0 mm	8 ½ in 216 mm
47-5032	45° Up 2.5 mm	8 ½ in 216 mm
47-5033	45° Up 3.0 mm	8 ½ in 216 mm
47-5034	45° Up 4.0 mm	8 ½ in 216 mm



Smith-Peterson Laminectomy Rongeur

Double-Action

CODE	DESCRIPTION	LENGTH
53-1080	Straight, 4 x 15 mm	7 ½ in 191 mm
53-1081	Slightly Curved, 4 x 15 mm	7 ½ in 191 mm
53-1083	Straight	9 ½ in 241 mm
53-1084	Slightly Curved	9 ½ in 241 mm
53-1085	Full Curve	9 ½ in 241 mm



Spurling-Kerrison Rongeur

CODE	DESCRIPTION	LENGTH
32-3426	Bite 3 mm, Up Cut 40°	8 in 203 mm



Rongeurs (Micro)

Decker Micro Rongeur

Alligator Action

CODE	DESCRIPTION	BITE	LENGTH
53-4000	Straight	2 x 6 mm	6 in 152 mm
53-4002	Curved Left	2 x 6 mm	6 in 152 mm



53-4000

Micro Friedman Rongeur

CODE	DESCRIPTION	JAWS	LENGTH
30-0201	Straight, Very Delicate	1.5 mm	5 ½ in 140 mm
30-0202	Curved, Very Delicate	1.5 mm	5 ½ in 140 mm
30-0203	Straight, Delicate	2 mm	6 in 152 mm
30-0204	Curved, Delicate	2 mm	6 in 152 mm



30-0202

Micro Rongeur

Bayonet

CODE	DESCRIPTION	JAWS	LENGTH
46-2601	40° Up	1 mm	2 ¾ in 70 mm
46-2602	40° Up	2 mm	2 ¾ in 70 mm
46-2603	40° Up	3 mm	2 ¾ in 70 mm



46-2601

Rongeurs

Cottle Jansen Rongeur

CODE	DESCRIPTION	LENGTH
30-5312	Angled Jaws, 12 x 5 mm	6 ³ / ₄ in 171 mm

Image Not Available

Cushing Rongeur

CODE	DESCRIPTION	BITE	LENGTH
30-3185	Straight	6 mm	8 in 203 mm

Image Not Available

De Vibiss Rongeur

CODE	DESCRIPTION	LENGTH
53-1030	With One Extra Blade	8 ¹ / ₆ in 206 mm



Olivecrona Rongeur

CODE	DESCRIPTION
31-0401	Curved Light

Image Not Available

Saws (Guides)

Bailey Gigli Saw Guides

CODE	DESCRIPTION	LENGTH
14-1020	Straight	12 in 305 mm
14-1021	Curved	12 in 305 mm



Poppen Saw Guide

CODE	DESCRIPTION	LENGTH
14-1025	Saw Guide	11 in 279 mm

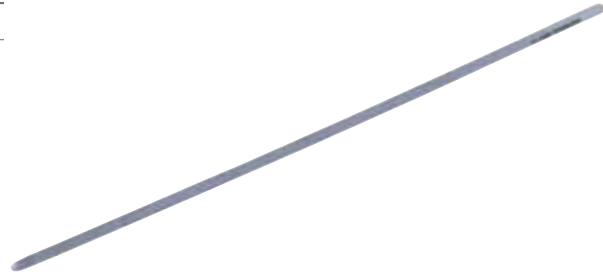

Saws (Handles)

Gigli Saw Handle

CODE	DESCRIPTION
57-6407	Loop Grip with Snap Lock

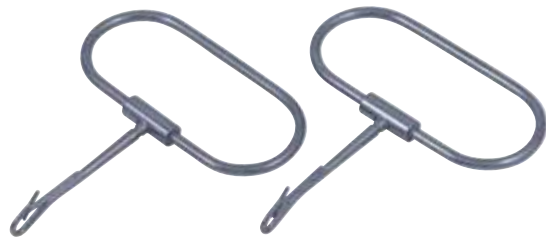

Gigli Saw Handle Loop

CODE	DESCRIPTION	LENGTH
11-1015	One Pair	1 3/4 in 44 mm

Image Not Available



Saws (Handles)

Gigli Wire Handle

CODE	DESCRIPTION
57-6406	Loop Grip, Sold as Pair



Gigli Wire Saw Handle

CODE	DESCRIPTION
57-6402	Sold in Pairs



Gigli Wire Saw Handle

CODE	DESCRIPTION
57-6407L	Sold in Pairs, With Snap Lock



Strully Gigli Saw Handles

CODE	DESCRIPTION	LENGTH
11-1020C	Loop, One Pair	3¼ in 83 mm
11-1021C	Solid, One Pair	3½ in 89 mm



Saws (Wire)

Gigli (Olivecrona) Wire Saw

CODE	LENGTH
57-6430	11 ³ / ₄ in 298 mm
57-6450	19 ³ / ₄ in 502 mm
57-6460	23 ³ / ₄ in 603 mm
57-6470	27 ¹ / ₂ in 699 mm



57-6430

Gigli Twisted Wire Saw

Package of 10

CODE	LENGTH
75-1003	12 in 305 mm
75-1004 Package of 10	20 in 508 mm

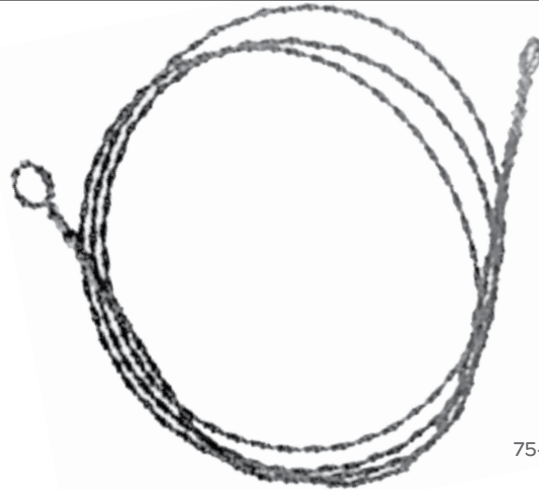

75-1004

Olivecrona-Gigli Wire Saw

Stille Type, Package of 10

CODE	LENGTH
75-1018	12 in 305 mm
75-1019	16 in 406 mm
75-1020	20 in 508 mm

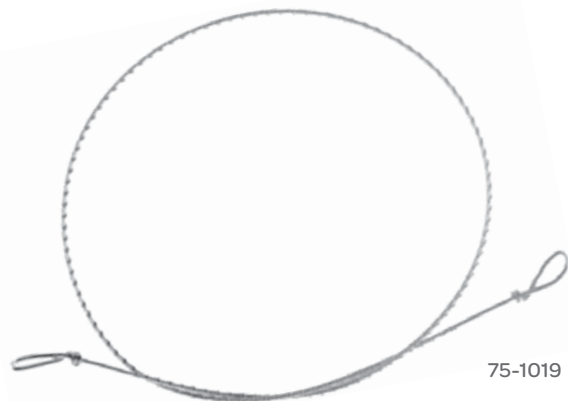

75-1019

Saws (Wire)

Tyler-Gigli Wire Saw

Package of 10

CODE	DESCRIPTION	LENGTH	
75-1013	Large Cut	12 in	305 mm
75-1012	Large Cut	20 in	508 mm

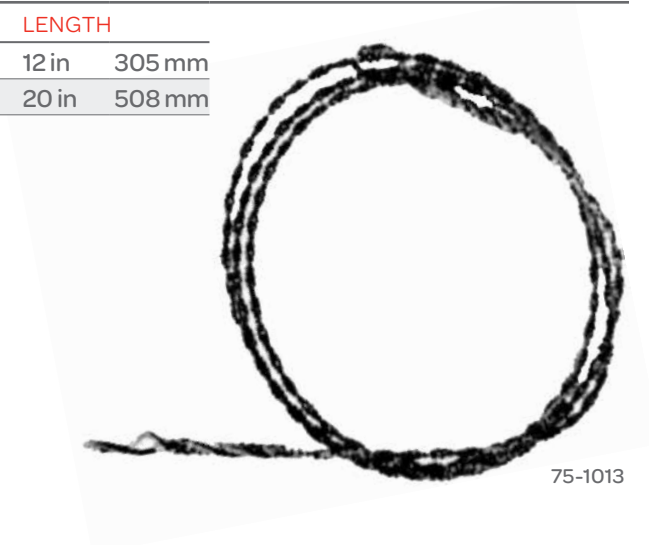

Scissors (Bayonet)

Malis Bayonet Scissors

Flat Handle, Titanium

CODE	DESCRIPTION	WORKING LENGTH		LENGTH	
58-5451T	Straight, Fine Tip	3 3/4 in	95 mm	9 1/2 in	241 mm
58-5450T	Straight, Regular Tip	3 3/4 in	95 mm	9 1/2 in	241 mm
58-5454T	Curved Up, Regular Tip	3 3/4 in	95 mm	9 1/2 in	241 mm

Image Not Available



Yasargil Bayonet Scissors

Flat Bayonet Handle

CODE	DESCRIPTION	LENGTH	
58-1929	125° Reverse Angle	7 1/8 in	181 mm
58-1920	Straight	7 1/2 in	191 mm
58-1921	Curved	7 1/2 in	191 mm
58-1931	Curved	8 3/4 in	222 mm

Image Not Available



Scissors (Dural)

Frazier Dural Scissors

CODE	DESCRIPTION	LENGTH
57-2516	Angled, One Blade Has Probe Tip	6½ in 165 mm
54-1055	Angled, One Blade Has Probe Tip	6¾ in 171 mm



57-2516

Taylor Dural Scissors

CODE	DESCRIPTION	LENGTH
54-1050	Dural Scissors	5¾ in 146 mm



Scissors (Ganglion)

Adson Ganglion Scissors

CODE	DESCRIPTION	LENGTH
54-1005	Straight, Sharp/Sharp	6¼ in 159 mm
54-1006	Curved, Sharp/Sharp	6¼ in 159 mm

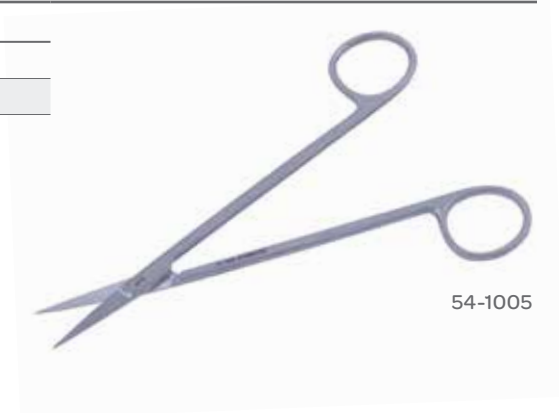

54-1005

Scissors (Micro)

E-Series Scissors

Titanium, Serrated Jaws

CODE	DESCRIPTION	LENGTH
80-6008	Straight, Fine Tip	6 in 152 mm
80-6009	Straight, Regular Tip	6 in 152 mm

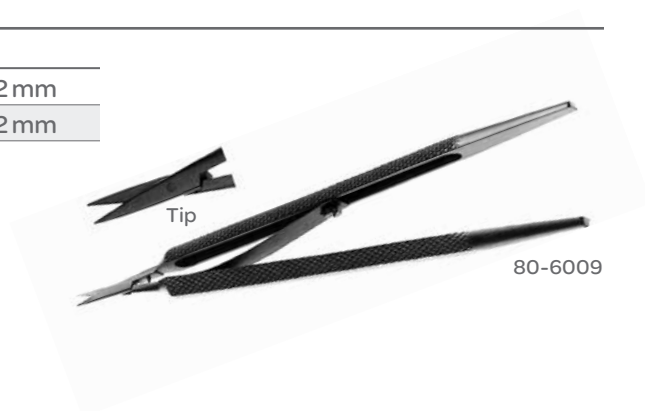

E-Series XF Scissors

Titanium, Extra Fine

CODE	DESCRIPTION	LENGTH
80-6640	Straight	6 in 152 mm
80-6642	Straight Blade, 60° Angle	6 in 152 mm
80-6641	Curved	6 in 152 mm



Micro Scissors

Titanium

CODE	DESCRIPTION	LENGTH
80-2005	Straight	5½ in 140 mm
58-2108B	Straight, Bayonet, Blunt Blade	10¼ in 260 mm
80-2006	Curved Tip	5½ in 140 mm
58-2109B	Curved Up, Bayonet, Blunt Blade	10¼ in 260 mm

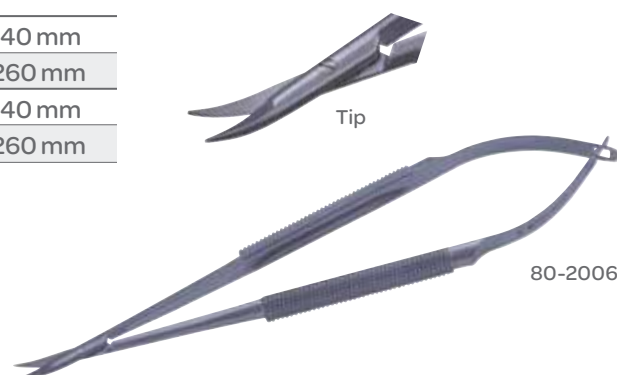

Scissors (Micro Bayonet)

Micro Bayonet Scissors

Serrated Blade

CODE	DESCRIPTION	LENGTH
57-2610	Straight, Fine Handle	9¼ in 235 mm
57-2720	Straight, Blunt	9¼ in 235 mm

Image Not Available



Rhoton Micro Bayonet Scissors

CODE	DESCRIPTION	LENGTH
59-5932	Straight	8¼ in 210 mm

Image Not Available



Yasargil Micro Bayonet Scissors

CODE	DESCRIPTION	LENGTH
59-1620	Straight	6½ in 165 mm
59-2033	Straight, Long Blades	8 in 201 mm
59-2320	Straight	8½ in 215 mm
59-2330	Straight, Vannas Blades	8½ in 215 mm
59-2031	Curved Up, Long Blades	8 in 200 mm
59-2034	Curved Up	8 in 200 mm
59-2336	Curved Up	9 in 230 mm
59-2321	Curved	9 in 230 mm
59-2331	Curved, Vannas Blades	9 in 230 mm



59-2320

Scissors (Micro Pituitary)

Micro Pituitary Style Scissors

Alligator Action, Semi-Malleable Shaft

CODE	DESCRIPTION	LENGTH
54-5607	Straight	7½ in 181 mm
54-5608	Curved Left	7½ in 181 mm
54-5609	Curved Right	7½ in 181 mm



Scissors (Microsurgical)

Decker Microsurgical Scissors

Alligator Action

CODE	DESCRIPTION	LENGTH
54-5604	Straight	5½ in 140 mm
54-5605	Curved Left	5½ in 140 mm
54-5606	Curved Right	5½ in 140 mm



Scissors (Neurosurgical)

Malis Neurosurgical Scissors

CODE	DESCRIPTION	LENGTH
54-1015	Curved	7 in 178 mm



Scissors (Neurosurgical)

Strully Neuro Scissors

CODE	DESCRIPTION	LENGTH
57-2520	Curved, Both Blades, Probe Tip	8 in 203 mm

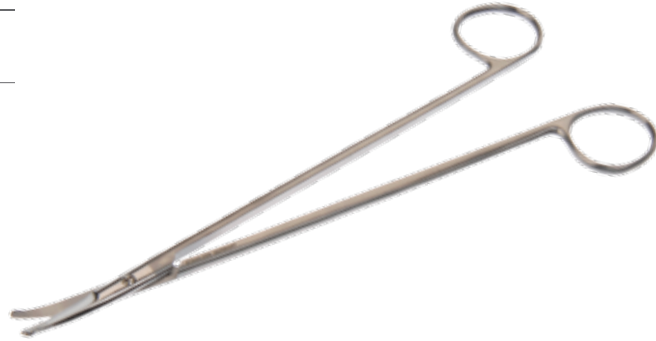

Scissors (Neurovascular)

Spetzler Neurovascular Scissors

Titanium, Bayonet

CODE	DESCRIPTION	LENGTH
80-1907	Straight, 4 mm	9½ in 241 mm
80-1908	Curved, 4 mm, 30°	9½ in 241 mm



80-1907

Scissors (Pituitary)

Sweet Pituitary Scissors

Alligator Blades, Straight

CODE	BLADE LENGTH	LENGTH
54-1091	¾ in 10 mm	5½ in 140 mm



Scissors

Jacobson Scissors

CODE	DESCRIPTION	LENGTH
58-1524	Straight, Flat Bayonet Handle	7¼ in 184 mm
58-1525	Curved, Flat Bayonet Handle	7¼ in 184 mm



58-1522

Malis Scissors

Titanium

CODE	DESCRIPTION	LENGTH
80-1520	Straight, Fine Tip	6¾ in 171 mm
80-1521	Straight, Curved Fine Tip	6¾ in 171 mm
80-1522	Straight, Bayonet, Regular Tip Working Distance 3¼ in (83 mm)	9½ in 241 mm
80-1523	Straight, Bayonet, Fine Tip Working Distance 3¼ in (83 mm)	9½ in 241 mm
80-1526	Curved Down, Bayonet, Regular Tip Working Distance 3¼ in (83 mm)	9½ in 241 mm
80-1524	Curved Up, Bayonet, Regular Tip Working Distance 3¼ in (83 mm)	9½ in 241 mm
80-1525	Curved Up, Bayonet, Fine Tip Working Distance 3¼ in (83 mm)	9½ in 241 mm



80-1520

Rhoton Scissors

Titanium

CODE	DESCRIPTION	WORKING DISTANCE	LENGTH
80-1722	Straight Tip, Bayonet	3½ in 89 mm	8½ in 216 mm
80-1744	Straight Tip, Bayonet	3¾ in 95 mm	9½ in 241 mm
80-1723	Curved Tip, Bayonet	3½ in 89 mm	8½ in 216 mm
80-1745	Curved Tip, Bayonet	3¾ in 95 mm	9½ in 241 mm



80-1722

Scissors

Rhoton Scissors

Titanium

CODE	DESCRIPTION	LENGTH
80-1720	Straight Tip	7 in 178 mm
80-1721	Curved Tip	7 in 178 mm



Scissors

Bayonet, Sharp/Sharp

CODE	DESCRIPTION	LENGTH
80-2073	Straight	4 in 100 mm
80-2074	Straight	4 in 100 mm
80-2072	Curved	4 in 100 mm

Image Not Available



Scissors (Trigeminal)

Dandy Trigeminal Scissors

CODE	DESCRIPTION	LENGTH
54-1041	Curved Sharp Tips, Angled Shaft	7 ³ / ₄ in 197 mm

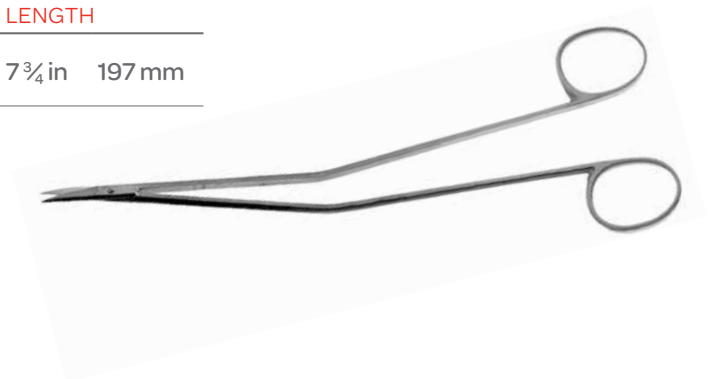

Scoops (Pituitary)

Fahlbusch Pituitary Scoop

CODE	DESCRIPTION	LENGTH
58-3626	Pituitary Scoop	10 ¼ in 260 mm

Image Not Available



Separators (Dural)

Dorsey Dural Separator

CODE	BLADE (W X L)	LENGTH
65-1104	⅜ x 1 ½ in 5 x 26 mm	6 in 152 mm



Frazier Dural Separator

Tapered Blade Width, ¼–⅜ in (2–3 mm)

CODE	BLADE DEPTH	LENGTH
65-1100	½ in 13 mm	6 ½ in 165 mm



Hoehn Dura Separator

CODE	DESCRIPTION	LENGTH
57-3501	45° Angle	6 in 152 mm

Image Not Available



Hoehn Dural Separator

#1, 90° Angle

CODE	BLADE (W X L)	LENGTH
65-1101	⅛ x ½ in 3 x 13 mm	6 in 152 mm



Separators (Dural)

Horsley Dural Separator

CODE	DESCRIPTION	LENGTH
57-3510	40°	8 in 203 mm



Woodson Dural Separator & Spatula

CODE	DESCRIPTION	LENGTH
57-3516	4 mm Wide	10 in 254 mm

Image Not Available



Separators (Packer)

Woodson Separator Packer

Double-Ended with Groove in Blade

CODE	BLADE (W X L)	LENGTH
65-1135	1/8 x 1/2 in 3 x 13 mm	7 in 178 mm



Skull Tongs

Gardner-Wells Traction Tongs

CODE	DESCRIPTION
57-6804	Skull Tongs, Maximum Opening 6 1/4 in (160 mm)
57-6804T	Skull tongs, Titanium Maximum Opening 6 1/4 in 160 mm
57-6806	Fix Screw, Spring-Loaded

Image Not Available



Skull Tongs

Raney-Crutchfield Skull Tongs

CODE	DESCRIPTION
------	-------------

57-6701	Skull Tongs
57-6702	Skull Tongs

Image Not Available



Skull Tong

CODE	DESCRIPTION
------	-------------

66-1025	Skull Tongs, Maximum Opening 6 ¼ in (160 mm) With One Spring-Loaded Point for Cervical Traction
66-1026	Adjustment Nut (Sold Each)
66-1027	S-Hook for Tongs
66-102	Test Bar



66-1025

Spatulas (Brain)

Cushing Brain Spatula

Double-Ended

CODE	WIDTH	LENGTH
57-3017	16 x 21 mm	6 ¾ in 171 mm
57-3020	21 x 26 mm	8 in 203 mm

Image Not Available



Cushing Brain Spatula-Spoon

CODE	CUP WIDTH	LENGTH
60-1010	½ in and ¾ in (13 mm and 19 mm)	6 ¾ in 171 mm



Spatulas (Brain)

Davis Brain Spatula

CODE	DESCRIPTION	LENGTH
22-0051	¼ in 6 mm	7 in 178 mm
22-0054	⅕ in 8 mm	7 in 178 mm
22-0060	½ in 13 mm	7 in 178 mm
22-0063	⅝ in 16 mm	7 in 178 mm
22-0073	1 in 25 mm	7 in 178 mm

Image Not Available



Davis Brain Spatula

Double-Ended, Malleable, Stainless Steel

CODE	WIDTH	LENGTH
59-1080	¼ in 6 mm	7 in 178 mm
59-1081	⅜ in 10 mm	7 in 178 mm
59-1082	½ in 14 mm	7 in 178 mm
59-1083	⅝ in 16 mm	7 in 178 mm
59-1084	¾ in 19 mm	7 in 178 mm
59-1085	1 in 25 mm	7 in 178 mm
59-1086	1¼ in 32 mm	7 in 178 mm
59-1087	1½ in 38 mm	7 in 178 mm



59-1084

Davis Insulated Brain Spatula

Malleable

CODE	DESCRIPTION	LENGTH
22-0051I	¼ in 6 mm	7 in 178 mm
22-0054I	⅕ in 8 mm	7 in 178 mm
22-0057I	⅜ in 10 mm	7 in 178 mm
22-0060I	½ in 12 mm	7 in 178 mm
22-0063I	⅝ in 16 mm	7 in 178 mm
22-0070I	⅞ in 22 mm	7 in 178 mm
22-0073I	1 in 25 mm	7 in 178 mm

Image Not Available



Spatulas (Brain)

Scoville Brain Spatula

Double-Ended, Malleable

CODE	BLADE WIDTHS	LENGTH
59-1070	$\frac{3}{8}$ and $\frac{1}{2}$ in	10 and 13 mm 7 in 178 mm
59-1071	$\frac{5}{8}$ and $\frac{3}{4}$ in	16 and 19 mm 7 in 178 mm



59-1071

Silicone Brain Spatula

CODE	DESCRIPTION	LENGTH
57-0002S	Set of 4 One of Each Size Below.	
57-0001	6.0 mm	6 $\frac{7}{8}$ in 175 mm
57-0002	9.0 mm	6 $\frac{7}{8}$ in 175 mm
57-0003	11 mm	6 $\frac{7}{8}$ in 175 mm
57-0004	13 mm	6 $\frac{7}{8}$ in 175 mm

Image Not Available



Spatulas (Nerve)

Davis Nerve Separator/Spatula

CODE	DESCRIPTION	LENGTH
57-3519	Semi-Sharp	7 $\frac{1}{2}$ in 191 mm

Image Not Available



Speculums (Transsphenoidal)

Hardy Nasal Bivalve Specula

Black Anodized Finish, Except Knob

CODE	DESCRIPTION	LENGTH
80-1350	Small	2 $\frac{3}{4}$ in 70 mm
80-1352	Standard	3 $\frac{1}{8}$ in 79 mm
80-1351	Acromegalic	3 $\frac{1}{2}$ in 89 mm



80-1350

Sponges (Tonsil)

Secto Tonsil Sponges

Sterile, 5 Per Card/Pouch, 25 Pouches Per Dispenser, 2 Dispenser Boxes Per Case.

CODE	DESCRIPTION	LENGTH	
81-1010	X-Ray Detectable	$\frac{5}{8}$ in	16 mm
81-1011	X-Ray Detectable	1 in	25 mm
81-1012	X-Ray Detectable	$1\frac{1}{4}$ in	32 mm

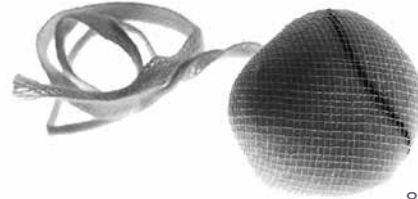

81-1012

Spoons (Pituitary)

Cushing Pituitary Spoon

Malleable Copper, Silver Plated

CODE	NO.	CUP WIDTH		CUP LENGTH		LENGTH	
60-1000	1	$\frac{1}{4}$ in	6 mm	$\frac{3}{8}$ in	10 mm	$9\frac{1}{4}$ in	235 mm
60-1001	2	$\frac{5}{16}$ in	8 mm	$\frac{1}{2}$ in	13 mm	$9\frac{1}{4}$ in	235 mm
60-1002	3	$\frac{5}{16}$ in	8 mm	$\frac{5}{8}$ in	16 mm	$9\frac{1}{4}$ in	235 mm
60-1003	4	$\frac{3}{8}$ in	10 mm	$\frac{5}{8}$ in	16 mm	$9\frac{1}{4}$ in	235 mm



60-1000

Spoons (Transsphenoidal)

Hardy Pituitary Spoon

Bayonet, Malleable

CODE	WORKING DISTANCE	LENGTH
80-1336	$4\frac{3}{4}$ in 121 mm	$9\frac{1}{4}$ in 235 mm



STA-MCA Kits



80-1820

Microvascular STA-MCA Kit

The Microvascular Kit is a coordinated instrument approach to the STA-MCA (Superficial Temporal Anastomosis to the Middle Cerebral Anastomosis). The Microvascular set of instruments includes eight titanium microvascular instruments and two stainless steel specially modified alm wound retractors, all in a Microcare stainless steel instrument case.

CODE	DESCRIPTION	LENGTH	
80-1820	Kit Includes Items Below:	7 in	178 mm
80-1800	Needle Holder, Curved, Two Each		
80-1803	Scissors, 60° Angled, Straight Tip		
80-1804	Scissors, 60° Angled, Curved Tip, Right		
80-1805	Scissors, 60° Angled, Curved Tip, Left		
80-1802	Scissors, Curved		
80-1801	Scissors, Straight		
80-1807	Microvascular Tying Forceps, Curved, Titanium, Tip Width 0.7 mm	7 in	178 mm
80-1806	Microvascular Tying Forceps, Straight, Titanium, Tip Width 0.6 mm	7 in	178 mm
80-1812	Microvascular Modified Alm Retractors, Black Anodized, 4 x 4 Prongs	3 in	76 mm
80-1813	Microvascular Modified Alm Retractors, Black Anodized, 12 x 12 Prongs	3¾ in	95 mm
80-1818	Microcare Instrument Case		

Suction Tubes

Malis-Frazier Suction Tube

CODE	DESCRIPTION	LENGTH
70-1104	7 French, Black Anodized	7½ in 191 mm

Image Not Available



Suction Tubes (Micro)

Yasargil Micro Suction Tube

CODE	DESCRIPTION	LENGTH
80-1621	Medium, O.D. 2.5 mm	14 in 356 mm
80-1622	Large, O.D. 3.5 mm	14 in 356 mm

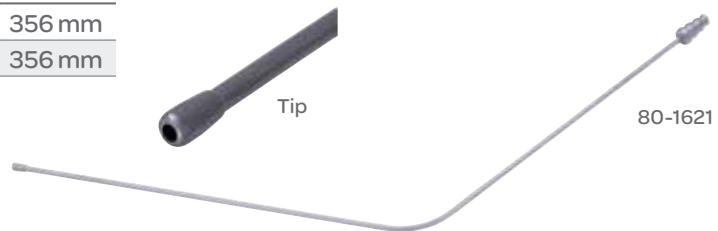

Suction Tubes (Neuro)

Rhoton Neuro Suction Tube

CODE	DESCRIPTION	LENGTH
58-6303	3 French, Straight Tip	3¼ in 83 mm
58-6305	5 French, Straight Tip	3¼ in 83 mm
58-6307	7 French, Straight Tip	3¼ in 83 mm
58-6310	10 French, Straight Tip	3¼ in 83 mm
58-6311	12 French, Straight Tip	3¼ in 83 mm
58-6313	3 French, Straight Tip	4 in 102 mm
58-6315	5 French, Straight Tip	4 in 102 mm
58-6317	7 French, Straight Tip	4 in 102 mm
58-6320	10 French, Straight Tip	4 in 102 mm
58-6322	12 French, Straight Tip	4 in 102 mm
58-6335	5 French, Angled Tube	5¼ in 133 mm
58-6337	7 French, Angled Tube	5¼ in 133 mm
58-6340	10 French, Angled Tube	5¼ in 133 mm
58-6327	7 French, Straight Tip	5½ in 140 mm
58-6330	10 French, Straight Tip	5½ in 140 mm
58-6331	12 French, Straight Tip	5½ in 140 mm



Suction Tubes (Styler)

Wire Styler

CODE	DESCRIPTION
46-4000	Used With Dural Suction Retractors for Cleaning and Storage

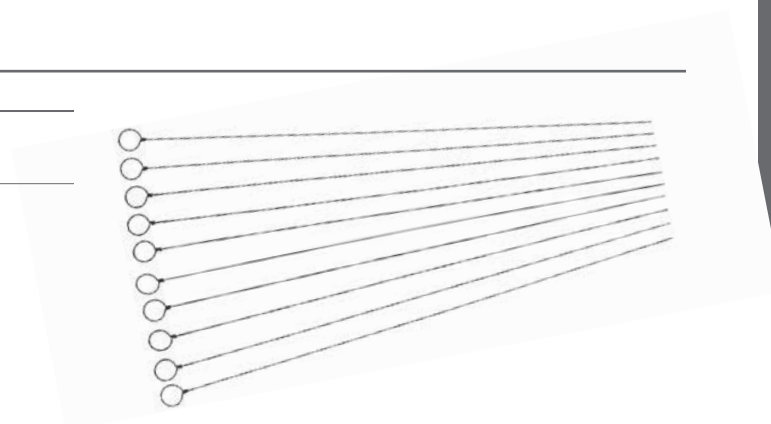

Suction Tubes (Teardrop)

Fukushima Tapered Teardrop Suction Tube

Malleable Tube

CODE	DESCRIPTION	LENGTH
67-7850	4 French	6 ¼ in 159 mm
67-7851	5 French	6 ¼ in 159 mm
67-7852	6 French	6 ¼ in 159 mm
67-7853	7 French	6 ¼ in 159 mm
67-7854	8 French	6 ¼ in 159 mm
67-7855	9 French	6 ¼ in 159 mm
67-7856	4 French	7 in 178 mm
67-7857	5 French	7 in 178 mm
67-7858	6 French	7 in 178 mm
67-7859	7 French	7 in 178 mm
67-7860	8 French	7 in 178 mm
67-7861	9 French	7 in 178 mm
67-7862	4 French	8 in 203 mm
67-7863	5 French	8 in 203 mm
67-7864	6 French	8 in 203 mm
67-7865	7 French	8 in 203 mm
67-7866	8 French	8 in 203 mm
67-7867	9 French	8 in 203 mm
67-7868	4 French	9 in 229 mm
67-7869	5 French	9 in 229 mm
67-7870	6 French	9 in 229 mm
67-7871	7 French	9 in 229 mm
67-7872	8 French	9 in 229 mm
67-7873	9 French	9 in 229 mm



Suction Tubes (Transsphenoidal)

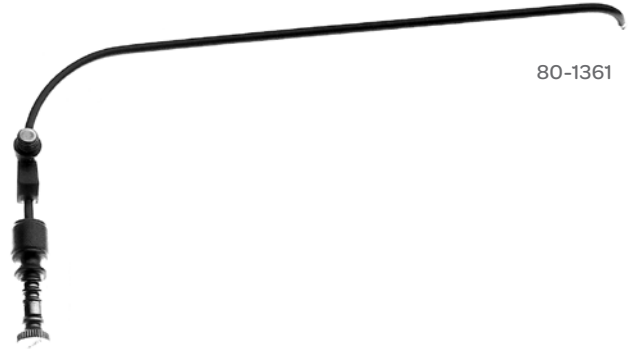

80-1361

Hardy Suction Tube

Angular with Thumb Control, Insulated

CODE	DESCRIPTION	LENGTH
80-1361	7 French, Curved Right	7¼ in 184 mm
80-1360	7 French, Curved Left	7¼ in 184 mm

Suction Tubes



70-1146

Adson Suction Tube

Curved Tip with Thumb Piece to Control Suction

CODE	DESCRIPTION	LENGTH
70-1146	12 French	5½ in 140 mm
70-1148	15 French	7½ in 191 mm

Suction Tubes



Frazier Suction Tube

CODE	DESCRIPTION	TUBING LENGTH
70-1079	Angular, With Thumb Control, 7 French	4½ in 114 mm
70-1005	Angular, With Thumb Control, Insulated, 7 French	4½ in 114 mm
70-1080	Angular, With Thumb Control, 9 French	4½ in 114 mm
70-1006	Angular, With Thumb Control, Insulated, 9 French	4½ in 114 mm
70-1081	Angular, With Thumb Control, 11 French	4½ in 114 mm
70-1007	Angular, With Thumb Control, Insulated, 11 French	4½ in 114 mm
70-1100	Straight, With Thumb Control, 7 French	5¼ in 133 mm
70-1101	Straight, 9 French, With Thumb Control,	5¼ in 133 mm
70-1102	Straight, 11 French, With Thumb Control,	5¼ in 133 mm
70-1087	Angular, With Thumb Control, 7 French	7½ in 191 mm
70-1088	Angular, With Thumb Control, 9 French	7½ in 191 mm
70-1089	Angular, With Thumb Control, 11 French	7½ in 191 mm
70-1015	Angular, With Thumb Control, Insulated, 7 French	7½ in 191 mm
70-1016	Angular, With Thumb Control, Insulated, 9 French	7½ in 191 mm
70-1017	Angular, With Thumb Control, Insulated, 11 French	7½ in 191 mm



Malis-Frazier Suction Tube

CODE	DESCRIPTION	TUBING LENGTH
70-1103	Black Anodized, 7 French	4¼ in 108 mm

Suction Tubes

Pribram Suction Tube

16 Gauge, With Thumb Control

CODE	TUBING LENGTH	LENGTH
70-1128	5½ in	5½ in 140 mm
70-1130	5½ in	5½ in 140 mm



70-1128

Rhoton-Merz Suction Tube

50° Angle

CODE	DESCRIPTION	LENGTH
32-3721	7 French	4 in 100 mm
32-3722	10 French	4 in 100 mm

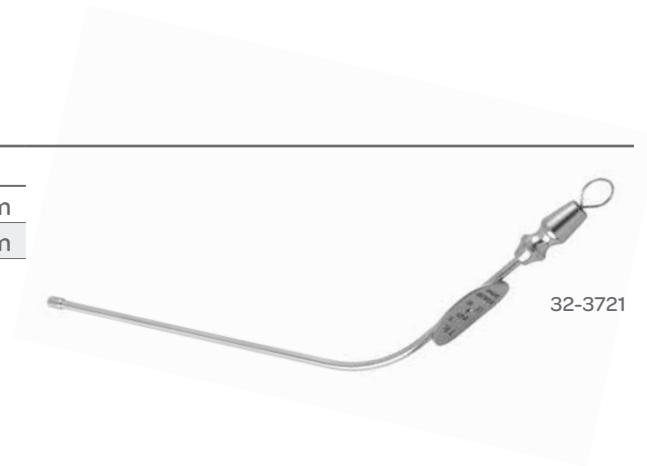

32-3721

Sachs Suction Tube

50° Angle

CODE	DESCRIPTION	SHAFT LENGTH
70-1160	Small, 8 French x 4 in (102 mm)	9⅝ in 244 mm
70-1161	Large, 15 French x 4½ in (114 mm)	9⅝ in 244 mm



70-1160

Symmetry Micro Instrument Kit

Image Not Available



Symmetry Micro Instrument Kit

	CODE	DESCRIPTION	TIP	LENGTH	COLOR	
	80-1003	Complete Set includes 1 each of all products listed below.				
NEEDLE HOLDERS	80-2069	Bayonet, Straight	1x6 mm	4 in	100 mm	Yellow
	80-2070	Bayonet, Curved	1x6 mm	4 in	100 mm	Yellow
	80-2071	Bayonet, Straight, Blunt		4 in	100 mm	Red
SCISSORS HOLDERS	80-2072	Bayonet, Curved, Sharp		4 in	100 mm	Red
	80-2073	Bayonet, Straight, Sharp		4 in	100 mm	Red
	80-2074	Bayonet, Horizontal, Sharp		4 in	100 mm	Red
FORCEPS	80-2066	Bayonet, Smooth	0.5 mm	4 in	100 mm	Green
	80-2067	Bayonet, Serrated	3.0 mm	4 in	100 mm	Green
	80-2068	Bayonet, Curved Left	0.75 mm	14 in	100 mm	Green
CUP FORCEPS	80-2060	Bayonet, Vertical	2.0 mm	4 in	100 mm	Blue
	80-2061	Bayonet, Vertical	4.0 mm	4 in	100 mm	Blue
	80-2062	Bayonet, Vertical	6.0 mm	4 in	100 mm	Blue
	80-2063	Bayonet, Horizontal	2.0 mm	4 in	100 mm	Blue
	80-2064	Bayonet, Horizontal	4.0 mm	4 in	100 mm	Blue
DISSECTORS	80-2065	Bayonet, Horizontal	6.0 mm	4 in	100 mm	Blue
	20-2081	Straight	1.2 mm	8 1/32 in	200 mm	
	20-2082	Straight	1.5 mm	8 1/32 in	200 mm	
	20-2083	Straight	2.0 mm	8 1/32 in	200 mm	
	20-2084	Straight	1.2 mm	10 in	260 mm	
DISC DISSECTOR	20-2085	Straight	1.5 mm	10 in	260 mm	
	20-2086	Straight	2.0 mm	10 in	260 mm	
TUMOR KNIVES	80-2078	Straight, Round	2.5 mm	8 1/32 in	200 mm	
	80-2075	Straight, Round	1.0 mm	8 1/32 in	200 mm	
	80-2077	Straight, Round	5.0 mm	8 1/32 in	200 mm	
MICRO HOOKS	20-8079	Straight, Sharp, 45°		8 1/32 in	200 mm	
	20-8079	Straight, Blunt, 45°		8 1/32 in	200 mm	
SUCTION	67-7862	Fukushima, Malleable, Teardrop, 4 French				
	67-7862	Fukushima, Malleable, Teardrop, 5 French				
	67-7862	Fukushima, Malleable, Teardrop, 6 French				
	67-7862	Fukushima, Malleable, Teardrop, 7 French				
	67-7862	Fukushima, Malleable, Teardrop, 8 French				
	67-7862	Fukushima, Malleable, Teardrop, 9 French				

Test Instruments (Neurological)

Millet Neurological Test Instrument

24-1010 Millet Neurological Test Instrument, incorporating a C-128 tuning fork.

CODE	DESCRIPTION	LENGTH
24-1010	Instrument Includes One Each of the Following:	8 1/8 in 206 mm
	MILLET Pinwheel	
	MILLET Rubber Percussor, Large	
	MILLET Rubber Percussor, Small	
	MILLET Cap for large Percussor	
	MILLET Brush Assembly	
	MILLET Needle	



Transsphenoidal Instruments (Hardy)

Hardy Curette

Bayonet, Working Distance 4 3/4 in (121 mm)

CODE	DESCRIPTION	TIP WIDTH	LENGTH
80-1347	45° Right	3 mm	9 1/4 in 235 mm
80-1334	45° Right	5 mm	9 1/4 in 235 mm
80-1348	90° Left	3 mm	9 1/4 in 235 mm
80-1333	90° Left	5 mm	9 1/4 in 235 mm
80-1345	Angled Down	3 mm	9 1/4 in 235 mm
80-1330	Angled Down	5 mm	9 1/4 in 235 mm
80-1346	Angled Up	3 mm	9 1/4 in 235 mm
80-1331	Angled Up	5 mm	9 1/4 in 235 mm
80-1335	Curved Left	3 mm	9 1/4 in 235 mm
80-1332	Curved Right	5 mm	9 1/4 in 235 mm



80-1347

Transsphenoidal Instruments (Hardy)

Hardy Dressing Forceps

Bayonet, Working Distance 4 ½ in (114 mm)

CODE	TIP WIDTH	LENGTH
30-1205	1 mm	8 ¼ in 210 mm



Hardy Enucleator

CODE	DESCRIPTION	LENGTH
80-1328	Bayonet, Three Prong Working Distance 3 ½ in (89 mm)	8 ⅙ in 205 mm
80-1311	Left, Micro, 2.4 mm	9 ¼ in 235 mm
80-1325	Left, 2.6 mm	9 ¼ in 235 mm
80-1312	Right, Micro, 2.4 mm	9 ¼ in 235 mm
80-1326	Right, 2.6 mm	9 ¼ in 235 mm
80-1329	Reverse Curve, 2.6 mm	9 ¼ in 235 mm

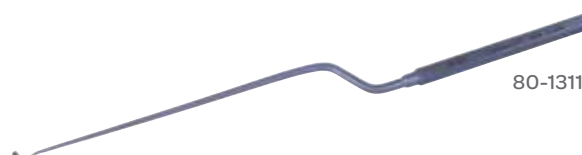

Hardy Instrument Case With Removable Panels

For Hardy Brand Transsphenoidal Instruments

CODE	DESCRIPTION	LENGTH
80-1355	Width 7 in (178 mm) Depth 2 ¼ in (57 mm)	11 in 279 mm



Transsphenoidal Instruments (Hardy)

Hardy Knife Handle

Working Distance 3 ½ in (89 mm)

CODE	DESCRIPTION	LENGTH
80-1314	Lateral, Bayonet	8 ¼ in 205 mm
80-1313	Vertical, Bayonet	8 ¼ in 205 mm



80-1314

Hardy Lip Retractor

CODE	DESCRIPTION
80-1337	Lip Retractor



Hardy Micro Dissector

Working Distance 4 ¾ in (121 mm)

CODE	DESCRIPTION	LENGTH
80-1316	Angled Down, Bayonet	9 ¼ in 235 mm
80-1315	Angled Up, Bayonet	9 ¼ in 235 mm

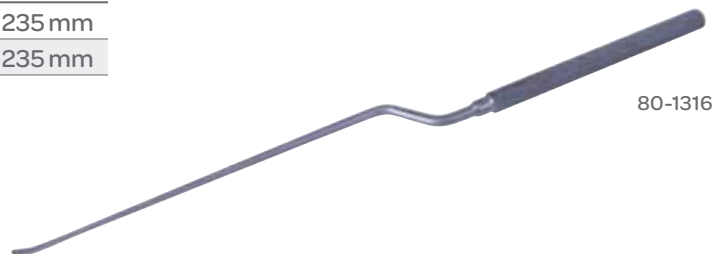

80-1316

Transsphenoidal Instruments (Hardy)

Hardy Nasal Bivalve Specula

Black Anodized Finish, Except Knob

CODE	DESCRIPTION	LENGTH
80-1350	Small	2 ³ / ₄ in 70 mm
80-1352	Standard	3 ¹ / ₈ in 79 mm
80-1351	Acromegalic	3 ¹ / ₂ in 89 mm



80-1350

Hardy Pituitary Spoon

Working Distance 4 ³/₄ in (121 mm)

CODE	DESCRIPTION	LENGTH
80-1336	Bayonet, Malleable	9 ¹ / ₄ in 235 mm



Trephines

Galt Trephine

CODE	DESCRIPTION	LENGTH
57-6313	Trephine	¹ / ₂ in 13 mm



Michele Trephine

Shaft Graduated

CODE	DESCRIPTION	LENGTH
57-6305	¹ / ₄ -1 ¹ / ₄ in, 5 mm	6 ¹ / ₄ in 159 mm

Image Not Available

