



Scan the code above to
learn more about our
Pediatric portfolio.



Pediatric



Approximators, Rib	PED-2
Clamps	PED-2
Dilators	PED-6
Dual-Purpose	PED-8
Elevators	PED-8
Forceps	PED-8
Hooks	PED-17
Needle Holders	PED-18
Probes	PED-21
Punches	PED-21

Rasps	PED-22
Retractors	PED-22
Rib Spreaders	PED-30
Rongeurs	PED-31
Scissors	PED-33
Sounds	PED-42
Speculums	PED-43
Suction Tubes	PED-43
Tissue Forceps	PED-45
Tourniquets	PED-49

Approximators (Rib)

Bailey Pediatric Rib Approximator

CODE	DESCRIPTION	LENGTH
54-2530	Pediatric	5¾ in 146 mm

Image Not Available



Clamps (Anastomosis)

Bartley Anastomosis Classic Clamp

Blades Calibrated at 5.0 mm Intervals

CODE	TEETH	JAW LENGTH	JAW DEPTH	LENGTH
37-1305	2x2 Vascular	1 in 25 mm	½ in 13 mm	5½ in 140 mm



Castaneda Anastomosis Clamp

CODE	DESCRIPTION	JAW LENGTH	JAW DEPTH	LENGTH
30-9003	Small	⅝ in 15 mm	⅕ in 5.0 mm	6 in 153 mm
30-9004	Medium	¾ in 18 mm	¼ in 6.0 mm	6 in 153 mm
30-9005	Large	⅞ in 21 mm	⅓ in 7.0 mm	6 in 153 mm



Clamps (A-V Fistula)

Noon A-V Fistula Clamp

CODE	ANGLE	TEETH	JAW LENGTH	LENGTH
37-1335	50°	1x2 Vascular	1 in 25 mm	4½ in 114 mm



Clamps (Hemostatic)

Gemini Classic Clamp

CODE	DESCRIPTION	LENGTH
19-5579	Curved, Delicate	5½ in 140 mm



Clamps (Multi-Purpose)

Castaneda Multi-Purpose Clamp

CODE	ANGLE	JAW LENGTH	LENGTH
30-9000	30°	1⅜ in 35 mm	5 in 127 mm
30-9001	50°	1⅜ in 35 mm	5 in 127 mm
30-9006	90°	1⅜ in 35 mm	5 in 127 mm
30-9011	Straight	1⅜ in 35 mm	5 in 127 mm



30-9011

Cooley Multi-Purpose Clamp

CODE	ANGLE	JAW LENGTH	LENGTH
37-1291	60°	1⅜ in 30 mm	6 in 153 mm
37-1292	90°	1⅜ in 30 mm	5½ in 140 mm



37-1291

DeBakey Multi Purpose Clamp

CODE	ANGLE	TEETH	JAW LENGTH	LENGTH
37-1321	60°	1x2 Vascular	1⅜ in 35 mm	6 in 153 mm



Clamps (Neonatal Vascular)

Neonatal Vascular Clamp

Curved Shanks, Calibrated Jaws, 1.0 mm wide, Horizontal Serrations

CODE	ANGLE	LENGTH
55-5040	Jaws 30°	5 in 125 mm
55-5042	Jaws 90°	5 in 125 mm

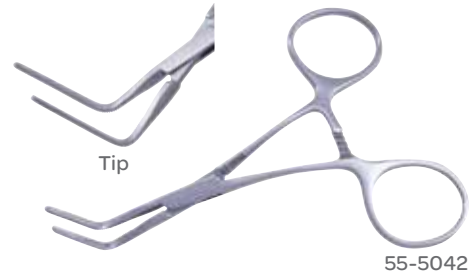

Clamps (Neonatal Vascular)

Castaneda Partial Occlusion Clamp

Spoon Type

CODE	JAW LENGTH	JAW DEPTH	LENGTH
30-9002	1 ⁵ / ₁₆ in 33 mm	⁵ / ₁₆ in 8.0 mm	4 ³ / ₄ in 121 mm



Clamps (Pediatric)

Cleveland Clinic Pediatric Clamp

CODE	DESCRIPTION	LENGTH
55-3533	Angled Left, Small Jaw	5 1/2 in 140 mm
55-3534	Angled Right, Small Jaw	5 1/2 in 140 mm



Clamps (Pediatric Ductus)

DeBakey Pediatric Ductus Clamp

CODE	SHANKS	JAWS	LENGTH
55-5053	Straight	Spoon	6 ³ / ₄ in 171 mm
55-5051	Straight	Straight	6 ³ / ₄ in 171 mm
55-5052	Angled	Straight	6 ³ / ₄ in 171 mm

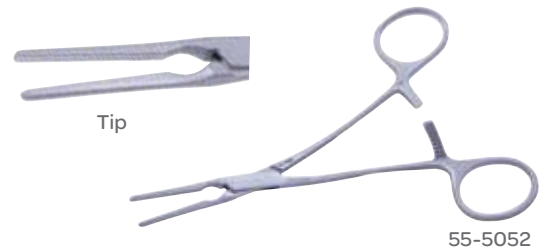

Clamps (Right Angle)

Delicate Classic Right Angle Clamp

CODE	DESCRIPTION	LENGTH
30-4493	Right Angle Clamp	5 ¹ / ₂ in 140 mm



Clamps (Stay Suture)

Gregory Stay Suture Clamp

Gold Band

CODE	DESCRIPTION	LENGTH
19-8027	Large #2, Smooth Jaws	³ / ₄ in 20 mm
19-8029	Large #4	1 ⁵ / ₈ in 40 mm



Clamps (Thoracic)

Castaneda-Mixer Thoracic Clamp

CODE	DESCRIPTION	LENGTH
19-8150	Smooth Jaws	5 ¹ / ₄ in 133 mm



Clamps (Vascular)

Cooley Pediatric Clamp

CODE	SHANKS	JAWS	LENGTH
55-5002	Straight	Angled	5½ in 140 mm
55-5004	Straight	Spoon	5½ in 140 mm
55-5005	Angled	Straight	5½ in 140 mm



55-5004

Clamps (Wire Holding)

Rubio Classic Wire Holder Clamp

Tungsten Carbide

CODE	DESCRIPTION	LENGTH
36-2023	Jaw Inserts	5 in 127 mm

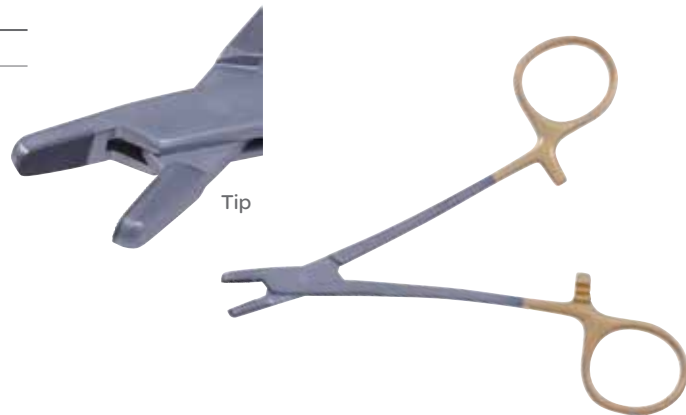

Tip

Dilators (Tracheal)

Delaborde Tracheal Dilator

Tri-Valve

CODE	JAW WIDTH	JAW THICKNESS	TOTAL SPREAD	LENGTH
25-4002	⅜ in 5.0 mm	¼ in 6.0 mm	1⅝ in 33 mm	5¼ in 133 mm

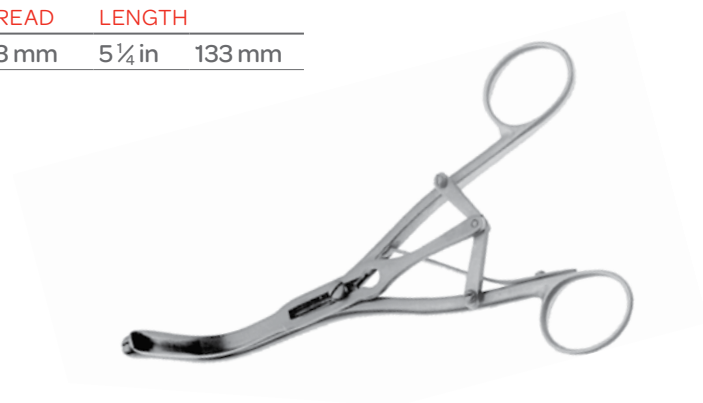

Dilators (Tracheal)

Trousseau Tracheal Dilator

CODE	JAW WIDTH (CLOSED)	JAW THICKNESS	TOTAL SPREAD	LENGTH
25-5569	1/8 in 3.0 mm	1/8 in 3.0 mm	1 1/4 in 32 mm	5 1/4 in 133 mm



Dilators (Vascular)



25-8036



25-8037



25-8039

Garrett Vascular Dilator

CODE	DESCRIPTION	LENGTH
25-8036	1.0 mm, Malleable Shaft	5 1/2 in 140 mm
25-8037	1.5 mm, Malleable Shaft	5 1/2 in 140 mm
25-8038	2.0 mm, Malleable Shaft	5 1/2 in 140 mm
25-8039	2.5 mm, Malleable Shaft	5 1/2 in 140 mm
25-8022	4.0 mm, Malleable Shaft	8 1/2 in 216 mm
25-8024	5.0 mm, Malleable Shaft	8 1/2 in 216 mm

Dual-Purpose (Needle Holders, Forceps & Scissors)

Combination Needle Holder & Forceps

CODE	DESCRIPTION	LENGTH
30-8002	Needle Holder, Forceps	5½ in 140 mm



Olsen-Hegar Classic Plus Needle Holder & Scissors

Tungsten Carbide

CODE	DESCRIPTION	LENGTH
36-4000	Jaw Inserts	5½ in 140 mm



Elevators (Periosteal)



Carroll Periosteal Elevator

CODE	DESCRIPTION	BLADE WIDTH	BLADE WIDTH	LENGTH
65-2549	Double-Ended	⅛ in 3.0 mm	⅛ in 10 mm	5½ in 140 mm

Forceps (Alligator)

Hoen Alligator Forceps

CODE	DESCRIPTION	TIP WIDTH	TEETH	SHAFT LENGTH
30-1230	Alligator Action	2.2 mm	1x2	5½ in 140 mm



Forceps (Bone Cutting)

Liston Bone Cutting Forceps

CODE	DESCRIPTION	LENGTH
30-1310	Straight	5½ in 140 mm



Forceps (Delicate)

Delicate Kocher Classic Forceps

Delicate, 1 x 2 Teeth

CODE	DESCRIPTION	LENGTH
30-4490	Straight	5½ in 140 mm
30-4491	Curved	5½ in 140 mm

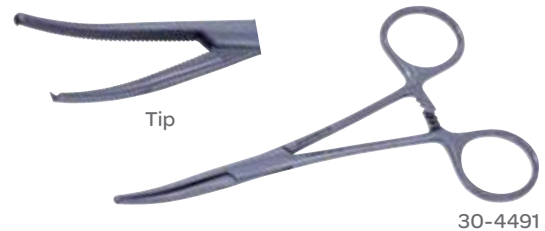

Forceps (Dressing)

Adson Dressings Forceps

CODE	DESCRIPTION	TIP WIDTH	LENGTH
30-4214	Delicate	0.8 mm	5 in 127 mm
30-1185	Standard Delicate	1.2 mm	5 in 127 mm
30-1190	Standard Pattern	2.0 mm	7 in 178 mm

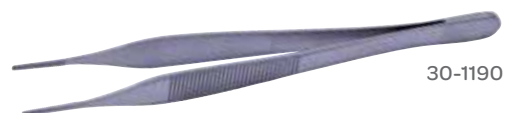

Children's Hospital Classic Dressing Forceps

Dissecting End, Delicate

CODE	DESCRIPTION	LENGTH
30-4208	Narrow Serrated Tips	5¾ in 146 mm



Forceps (Dressing)

Dressing Forceps

Serrated

CODE	DESCRIPTION	WORKING DISTANCE	LENGTH
30-4134	Tip Width 2.2 mm	$\frac{5}{8}$ in 16 mm	5 $\frac{1}{2}$ in 140 mm
30-6995	Bayonet Shape	3 $\frac{1}{8}$ in 80 mm	6 $\frac{1}{2}$ in 165 mm

Image Not Available



Ewald-Hudson Dressing Forceps

CODE	DESCRIPTION	TIP WIDTH	LENGTH
30-4215	Serrated	1.7 mm	5 in 127 mm

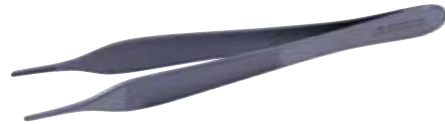

Forceps (Ear)

Hartmann Ear Forceps

CODE	DESCRIPTION	TIP SIZE	SHAFT LENGTH
30-6951	Angular, Serrated	$\frac{3}{10}$ in 7.6 mm	3 $\frac{1}{2}$ in 89 mm

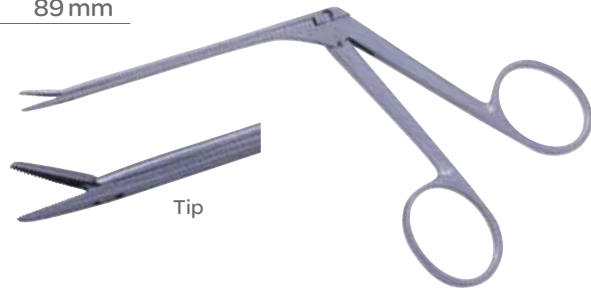

Lucae Ear Forceps

Bayonet Shape

CODE	WORKING DISTANCE	TIP WIDTH	LENGTH
30-6898	2 $\frac{3}{4}$ in 70 mm	2.0 mm	5 $\frac{1}{2}$ in 140 mm

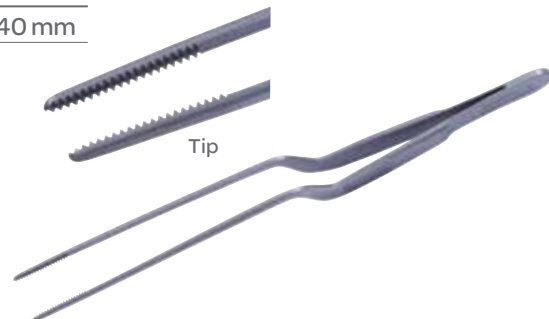

Forceps (Eye Dressing Hemostatic)

Eye Dressing Hemostatic Forceps

CODE	DESCRIPTION	TIP WIDTH	LENGTH
30-6520	Straight	1.0 mm	4 in 102 mm
30-6524	Curved	1.0 mm	4 in 102 mm



Forceps (Hemostatic)

Crile Classic Hemostatic Forceps

CODE	DESCRIPTION	LENGTH
30-4467	Straight, Delicate	5½ in 140 mm
33-4030	Straight, Bright Finish	5½ in 140 mm
32-4030	Straight, Standard Line	5½ in 140 mm
30-4468	Curved, Delicate	5½ in 140 mm
32-4031	Curved, Standard Line	5½ in 140 mm



30-4467

Halsted Hemostatic Forceps

CODE	DESCRIPTION	LENGTH
30-4105	Straight, 1x2 Teeth	5 in 127 mm
30-4106	Curved, 1x2 Teeth	5 in 127 mm



30-4105

Kelly Classic Hemostatic Forceps

CODE	DESCRIPTION	LENGTH
33-4020	Straight, Bright Finish	5½ in 140 mm
32-4020	Straight, Standard Line	5½ in 140 mm
34-4021	Curved, Low-Glare	5½ in 140 mm
32-4021	Curved, Standard Line	5½ in 140 mm



32-4020

Forceps (Hemostatic)

Kocher Hemostatic Forceps

CODE	DESCRIPTION	TEETH	LENGTH
32-4100	Straight, Bright Finish	1x2	5½ in 140 mm



Lahey Hemostatic Forceps

CODE	DESCRIPTION	LENGTH
30-4020	Straight with Full Serrations	5½ in 140 mm
30-4021	Curved with Full Serrations	5¾ in 146 mm



30-4020

Mixer Classic Hemostatic Forceps

CODE	DESCRIPTION	LENGTH
30-4485	Right Angle, Delicate	5½ in 140 mm



Mosquito Classic Hemostatic Forceps

CODE	DESCRIPTION	LENGTH
30-4471	Straight	4 in 102 mm
30-4472	Curved	4 in 102 mm
30-4474	Curved	5 in 127 mm
30-4470	Curved	6 in 152 mm

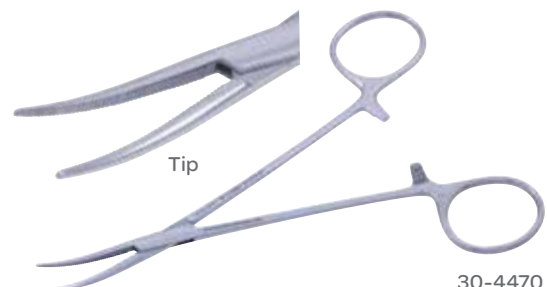

30-4470

Forceps (Hemostatic)

Providence Hospital Hemostatic Forceps

CODE	DESCRIPTION	LENGTH
32-4011	Curved, Bright Finish	5½ in 140 mm



Rochester Pean Classic Forceps

CODE	DESCRIPTION	LENGTH
30-4462	Curved, Delicate	5½ in 140 mm



Skillman Forceps

CODE	DESCRIPTION	LENGTH
30-4009	Curved	5 in 127 mm



Forceps (MagnaFree)

Crile MagnaFree Forceps

Non-Magnetic, Titanium, MRI Safe up to 1.5 Tesla

CODE	DESCRIPTION	LENGTH
65-2418	Straight	5½ in 140 mm
65-2419	Curved	5½ in 140 mm



65-2419

Forceps (MagnaFree)

E-Series Forceps

Straight

CODE	DESCRIPTION	CLOSING PRESSURE	TIP WIDTH	LENGTH
80-6001	Ring Tip, Titanium	(Appx.) 50 gms	1.0 mm	6 in 152 mm
80-6002	Ring Tip, Serrated, Titanium	(Appx.) 50 gms	1.0 mm	6 in 152 mm
80-6631	Extra Fine Utility	(Appx.) 25 gms	0.3 mm	6 in 152 mm



Forceps (Micro)

Micro Forceps

CODE	DESCRIPTION	TIP WIDTH	LENGTH
80-2000	Straight	0.3 mm	5½ in 140 mm

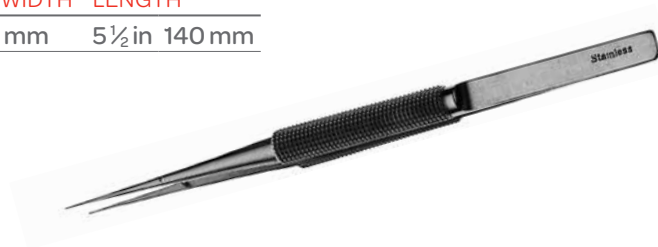

Forceps (Micro Cup)

Rhoton Micro Cup Forceps

Alligator Action

CODE	DESCRIPTION	TIP WIDTH	LENGTH
53-4005	Straight	1.0 mm	6 in 152 mm
53-4008	Straight	2.0 mm	6 in 152 mm
53-4007	Left	1.0 mm	6 in 152 mm
53-4006	Right	2.0 mm	6 in 152 mm



Forceps (Mosquito)

Halsted Classic Mosquito Forceps

CODE	DESCRIPTION	LENGTH
33-4000	Straight, Bright Finish	5 in 127 mm
34-3900	Straight, Low-Glare Finish	3½ in 89 mm
32-3900	Straight, Standard Line	3½ in 89 mm
32-4000	Straight, Standard Line	5 in 127 mm
33-3901	Curved, Bright Finish	3½ in 89 mm
33-4001	Curved, Bright Finish	5 in 127 mm
34-3901	Curved, Low-Glare Finish	3½ in 89 mm
34-4001	Curved, Low-Glare Finish	5 in 127 mm
32-3901	Curved, Standard Line	3½ in 89 mm
32-4001	Curved, Standard Line	5 in 127 mm



Forceps (Pediatric Nasal)

Weil-Blakesley Delicate Pediatric Nasal Forceps

CODE	DESCRIPTION	LENGTH
63-7424	45°	6¼ in 160 mm
63-7425	90°	6¼ in 160 mm
63-7423	Straight	6¼ in 160 mm
63-7423S	Straight with Suction	6¼ in 160 mm
63-7424S	Upturned 45° with Suction	6¼ in 160 mm



Forceps (Scalp)

Raimondi Scalp Forceps

Curved On Side

CODE	DESCRIPTION	TEETH	LENGTH
30-1360	Infant Scalp	1x2	5 in 127 mm

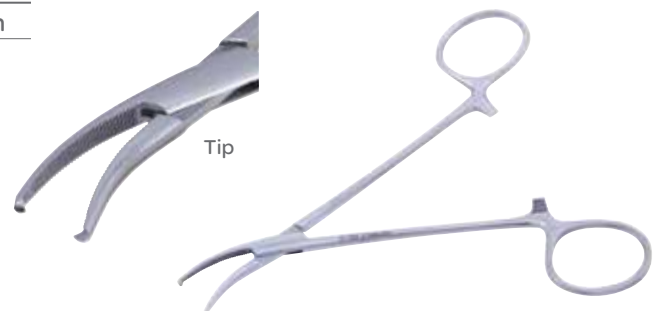

Forceps (Suture Tag)

Castaneda Suture Tag Forceps

CODE	DESCRIPTION	LENGTH
30-9007	1, Smooth Jaws	3½ in 89 mm
30-9008	2, Smooth Jaws	3½ in 89 mm
30-9009	3, Smooth Jaws	3½ in 89 mm
30-9010	4, Smooth Jaws	3½ in 89 mm



Forceps (Tissue)

Allis Classic Tissue Forceps

CODE	DESCRIPTION	TEETH	LENGTH
30-4466	Delicate	5x6	5 in 127 mm

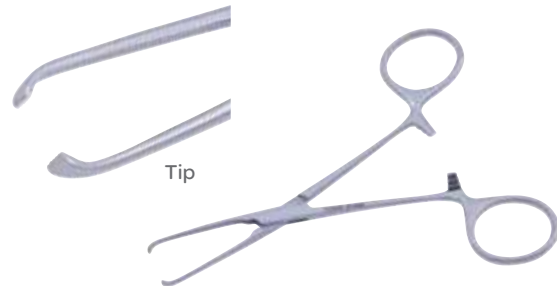

Iris Tissue Forceps

CODE	DESCRIPTION	TEETH	TIP WIDTH	LENGTH
30-6530	Straight	1x2	0.5mm	4 in 102 mm

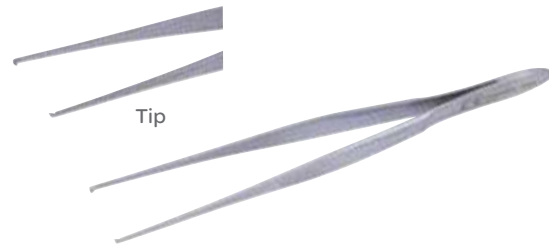

Forceps (Vascular)

DeBakey-Diethrich Vascular Forceps

Straight, Fine, Titanium

CODE	TIP WIDTH	LENGTH
30-8131	2.0 mm	6 in 153 mm
30-8400	1.8 mm	6 in 153 mm



Hooks (Dural)

Cushing Dural Hook

CODE	TIP DIAMETER	LENGTH
38-1028	2.0 mm	5½ in 140 mm



Frazier Dural Hook

CODE	TIP DIAMETER	LENGTH
38-1040	0.4 mm	5 in 127 mm



Lahey Clinic Dural Hook

CODE	DESCRIPTION	DEPTH	LENGTH
38-1042	Sharp	2.8 mm	5¼ in 133 mm



Hooks (Eye Fixation)

Guthrie Eye Fixation Hook

Two Sharp Teeth

CODE	DESCRIPTION	TIP WIDTH	LENGTH
38-6530	Standard	2.0 mm	4¾ in 121 mm
38-6531	Delicate	1.0 mm	5¼ in 133 mm

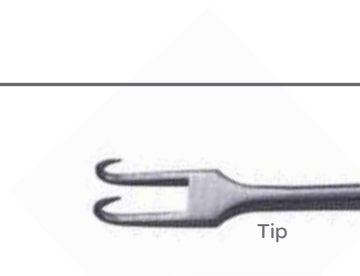

38-6530

Hooks (Iris)

Tyrell Iris Hook

CODE	DESCRIPTION	TIP WIDTH	LENGTH
38-6525	Sharp	0.4 mm	4 ¾ in 121 mm



Hooks (Skin)

Carroll Skin Hook

CODE	DESCRIPTION	HOOK SIZE	LENGTH
38-2515	Sharp	¼ in 3.0 mm	6 in 152 mm



Needle Holders (Extra Fine)

E-Series Extra Fine Needle Holder

CODE	DESCRIPTION	TIP WIDTH	LENGTH
80-6621	Curved, Titanium	0.5 mm	6 in 152 mm



Needle Holders (I.M.A.)

Jones I.M.A. Classic Plus Needle Holder

CODE	DESCRIPTION	LENGTH
36-3018	Straight	6 in 152 mm

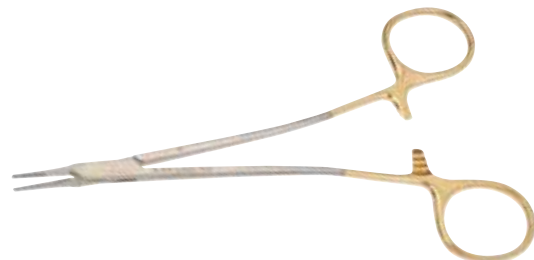

Needle Holders (Micro)

Micro Needle Holder

CODE	DESCRIPTION	TIP WIDTH	LENGTH
80-2002	Straight Tip	0.5 mm	5½ in 140 mm
80-2003	Curved Tip	0.5 mm	5½ in 140 mm



80-2002

Needle Holders (Microsurgical)

Castroviejo Microsurgical Classic Plus Needle Holder

Smooth Tungsten Carbide Jaw Inserts with Catch

CODE	DESCRIPTION	LENGTH
36-1006	Needle Holders	5½ in 140 mm
36-1007	Needle Holders	7 in 178 mm
36-1008	Needle Holders	8½ in 216 mm



36-1006

Needle Holders (Total Occlusion)

Total Occlusion Needle Holder

Tungsten Carbide Inserts

CODE	DESCRIPTION	LENGTH
37-4029	Smooth Jaws	4¾ in 121 mm



Baumgartner Classic Plus Needle Holder

CODE	DESCRIPTION	LENGTH
36-2010	Tungsten Carbide Jaw Inserts	5 in 127 mm



Needle Holders (Total Occlusion)

Baumgartner Needle Holder

CODE	DESCRIPTION	LENGTH
64-2511	Stainless Steel	5 in 127 mm



Crile-Wood Needle Holder

CODE	DESCRIPTION	LENGTH
64-2509	Stainless Steel Jaws	6 in 152 mm



E-Series Needle Holders

Curved, Titanium

CODE	DESCRIPTION	TIP WIDTH	LENGTH
80-6006	Fine Tip	0.7 mm	6 in 152 mm
80-6007	Standard Tip	1.0 mm	6 in 152 mm



Mayo-Hegar Needle Holder

CODE	DESCRIPTION	LENGTH
36-2015	Tungsten Carbide Jaw Inserts	5 in 127 mm
36-2016	Tungsten Carbide Jaw Inserts	6 in 152 mm



Ryder Classic Plus Needle Holder

Tungsten Carbide Jaw Inserts

CODE	DESCRIPTION	JAW WIDTH	LENGTH
36-3023	Serrated Jaws	1.0 mm	5 in 127 mm
36-3022	Smooth Jaws	1.0 mm	5 in 127 mm



Probes (Lachrymal)

Bowman Probe

Double-Ended, Malleable, Silver

CODE	DESCRIPTION	LENGTH
49-6500	0000-000	4 ⁷ / ₈ in 124 mm
49-6501	00-0	4 ⁷ / ₈ in 124 mm
49-6502	1-2	4 ⁷ / ₈ in 124 mm
49-6503	3-4	4 ⁷ / ₈ in 124 mm
49-6504	5-6	4 ⁷ / ₈ in 124 mm
49-6505	7-8	4 ⁷ / ₈ in 124 mm



Punches (Pediatric Antrum)

Pediatric Rotating Backbiting Antrum Punch

CODE	SHAFT	SIZE
63-7422	10.5 cm, Left-Side Cutting	1.5 x 5.0 mm
63-7421	10.5 cm, Right-Side Cutting	1.5 x 5.0 mm
63-7415	Rotates 360°, 1.5 x 5.0 mm Bite	1.5 x 5.0 mm
63-7420	With Rotation Post	1.5 x 5.0 mm
63-7416		1.5 x 5.0 mm



Rasps (Rib)

Alexander-Farabeuf Raspatory

CODE	DESCRIPTION	LENGTH
54-3134	Pediatric	6 in 152 mm



Doyen Rib Rasp

CODE	DESCRIPTION	LENGTH
54-3002	Left, Pediatric	6 in 152 mm
54-3001	Right, Pediatric	6 in 152 mm



Retractors (Blade)



Cloward Blade

CODE	DESCRIPTION	BLADE WIDTH	LENGTH
50-1050		18 mm	3 x 4 1/2 in 76 x 114 mm
50-1052	20 mm	20 mm	3 x 4 1/2 in 76 x 114 mm
50-1053	23 mm	23 mm	3 x 4 1/2 in 76 x 114 mm

Retractors (Dural Suction)



Dural Suction Retractor

CODE	ANGLE	TIP WIDTH	TIP DEPTH	WORKING DISTANCE	HANDLE LENGTH
46-3012	90°, Black, Micro	$\frac{9}{32}$ in 8.0 mm	$\frac{1}{4}$ in 6.0 mm	4 $\frac{3}{4}$ in 120 mm	4 $\frac{5}{8}$ in 117 mm

Retractors (Epicardial)



I.M.A. Epicardial Retractor

CODE	DESCRIPTION	LENGTH
80-1864	Mini, Gold Coated	1 in 25 mm



Parsonnet Epicardial Retractor

CODE	DESCRIPTION	PRONGS	LENGTH
37-4035	Self Retaining, Light Tension	3 x 3 Sharp	1 $\frac{7}{8}$ in 47 mm

Retractors (Hand-Held)



50-5645



50-4100

Children's Hospital Retractor

Double-Ended

CODE	DESCRIPTION	BLADE WIDTH	BLADE DEPTH	LENGTH
50-5645	S-Shaped	¼ in 6.0 mm	¾ in 19 mm	4 7/8 in 124 mm
		½ in 13 mm	¾ in 19 mm	
50-4100	Small	7/16 in 11 mm	7/8 in 22 mm	5 ½ in 140 mm
		9/16 in 14 mm	1 3/8 in 35 mm	

Crile Retractor



CODE	DESCRIPTION	BLADE WIDTH	BLADE DEPTH	LENGTH
50-4105	Crile Retractor, Double-Ended	¼ in 6.0 mm 3/16 in 5.0 mm	¾ in 19 mm 5/8 in 16 mm	4 ¼ in 108 mm

Pediatric Deaver Retractor



50-5630

CODE	DESCRIPTION	LENGTH
50-5630	Standard Handle	8 x 5/8 in 203 x 16 mm
50-5631	Standard Handle	8 x 2 ½ x 1 in 203 x 64 x 25 mm

Castaneda Infant Sternal Retractor



50-8060

CODE	SIZE	ARM LENGTH	BLADE WIDTH	TOTAL OPENING	BLADE DEPTH
50-8060	Small	2 5/8 in 67 mm	1 7/16 in 36 mm	3 in 76 mm	3/8 in 10 mm
50-8061	Large	3 in 76 mm	2 ½ in 64 mm	3 ½ in 89 mm	7/16 in 11 mm

Retractors (Infant Sternal)

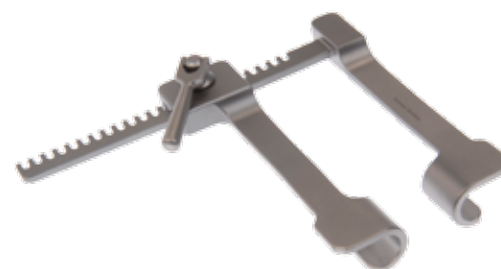

Castaneda Infant Sternal Retractor

CODE	DESCRIPTION	ARM LENGTH		BLADE LENGTH		BLADE DEPTH	SPREAD
54-1009	Aluminum Arms and Blades	3 7/8 in	79 mm	3/4 in	19 mm	1/2 in 13 mm	4 in 102 mm

Retractors (Laminectomy)



Poppen-Gelpi Laminectomy Retractor

CODE	DESCRIPTION	TOTAL OPENING		LENGTH	
50-1212	Self-Retaining	2 1/2 in	64 mm	5 1/2 in	140 mm

Retractors (Microvascular)



80-1813

Microvascular Modified Alm Retractor

CODE	DESCRIPTION	PRONGS	LENGTH	
80-1812	Black Anodized	4 x 4	3 in	76 mm
80-1813	Black Anodized	12 x 12	3 3/4 in	95 mm

Scoville Nerve Root Retractor



CODE	ANGLE	BLADE WIDTH	SHAFT LENGTH	HANDLE LENGTH
50-1293	90°	1/2 in 13 mm	4 1/4 in 107 mm	5 in 127 mm

Retractors (Nerve Root)

Weary Nerve Root Retractor



CODE	BLADE WIDTH	SHAFT LENGTH	HANDLE LENGTH
50-1310	7/16 in 11 mm	5 3/4 in 146 mm	5 3/4 in 146 mm

Retractors (Pediatric)

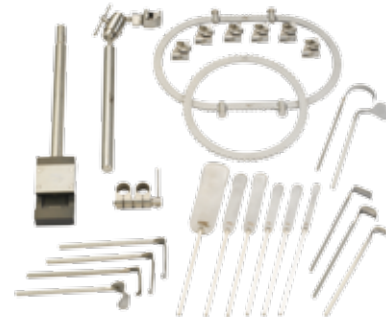

U.B. Pediatric System

CODE	DESCRIPTION
58-0145	Complete System

Retractors (Pediatric Rib)

Cooley Pediatric Rib Retractor

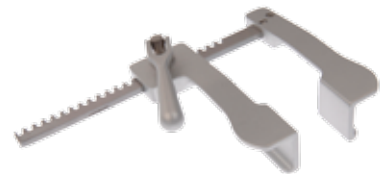

CODE	DESCRIPTION	ARM LENGTH	BLADE LENGTH	BLADE DEPTH	SPREAD
54-2101	Aluminum Arms & Blades	3 7/8 in 79 mm	1 in 25 mm	5/8 in 16 mm	4 3/4 in 121 mm

Burford Rib Retractor

Child Model, Self-Retaining with Rack and Pinion Action, Aluminum



CODE	SIZE	BLADE WIDTH	BLADE DEPTH	ARM LENGTH	TOTAL OPENING
50-8133	Small Slide Blades	1 5/8 in 41 mm	1 3/8 in 35 mm	6 in 152 mm	6 in 152 mm
	Large Slide Blades	1 5/8 in 41 mm	1 7/8 in 48 mm		

Retractors (Rib)



Rib Retractor

Infant, Self-Retaining with Rack and Pinion Action, Aluminum

CODE	ARM LENGTH	BLADE WIDTH	BLADE DEPTH	LENGTH
50-5625	3 in 76 mm	$\frac{3}{4}$ in 19 mm	$\frac{13}{16}$ in 21 mm	2½ in 64 mm



Rib Retractor-Contractor

Self-Retaining with Rack and Pinion Action, Aluminum

CODE	ARM LENGTH	BLADE WIDTH	BLADE DEPTH	LENGTH
50-8057	3¼ in 83 mm	$\frac{7}{8}$ in 22 mm	$\frac{3}{4}$ in 19 mm	2½ in 64 mm

Retractors (Scalp)



Contour Scalp Retractor

Self-Retaining, with Blades Curved to Fit Contour of Skull

CODE	PRONGS	TOTAL OPENING	BLADE WIDTH	BLADE DEPTH	LENGTH
50-1220	3 x 4 Blunt	2½ in 64 mm	$\frac{5}{8}$ in 16 mm	$\frac{5}{8}$ in 16 mm	5½ in 140 mm

Retractors (Scapular)



Davidson Scapular Retractor

CODE	HANDLE LENGTH	BLADE WIDTH	BLADE DEPTH	LENGTH
50-8096	6 in 152 mm	3½ in 89 mm	3 in 76 mm	3½ in 89 mm

Retractors (Scapular, Self-Retaining)



24-1007

Alm Retractor

CODE	DESCRIPTION	LENGTH
24-1007	Sharp, 4 x 4	2 3/4 in 70 mm
24-1008	Blunt, 4 x 4	2 3/4 in 70 mm



Cervical Retractor Set

CODE	DESCRIPTION	LENGTH
50-1390	Small, Self-Retaining with 7 Pairs of Blunt Blades	6 x 3 3/4 in 152 x 95 mm



50-1392

Retraction Blades

CODE	DESCRIPTION	BLADE DEPTH
50-1391	Blunt	25 mm
50-1392	Blunt	30 mm
50-1393	Blunt	35 mm
50-1394	Blunt	40 mm
50-1395	Blunt	45 mm
50-1396	Blunt	50 mm
50-1397	Blunt	55 mm



Cervical Retractor Body

CODE	DESCRIPTION
50-1356	Small

Retractors (Self-Retaining)

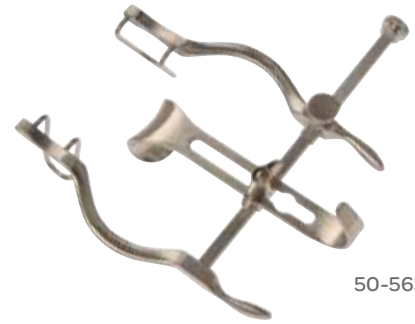

50-5651

Balfour Abdominal Retractor Miniature Model

CODE	DESCRIPTION	LENGTH
50-5651	Self Retaining, Fixed Lateral Fenestrated Blades, One Center Blade	1 in 25 mm
61-0610	3 x 3 Blunt Prongs	4 ½ in 114 mm

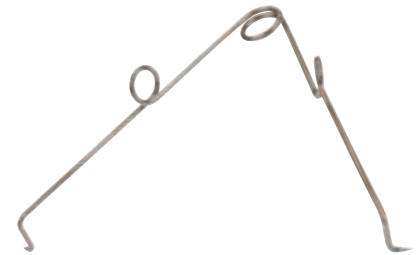

50-4350

Spring Retractor

CODE	DESCRIPTION	PRONGS	LENGTH
24-0301	Sharp	1x1	3 ½ in 89 mm
50-4350	Self-Retaining, Sharp	1	¾ x 3 ½ in 10 x 79 mm
50-4351	Self-Retaining, Semi-Sharp Blade	3	⅞ x ¾ x 3 ¼ in 11 x 14 x 83 mm
24-0301-H	With Heavy Wire, Sharp	1x1	3 ½ in 89 mm
24-0302-H	With Heavy Springs, Sharp	1x1	4 ½ in 114 mm



50-1194

Weitlaner Retractor

CODE	DESCRIPTION	TOTAL OPENING	PRONGS	LENGTH
50-1195	Self-Retaining Prongs, Blunt	2 ¼ in 57 mm	3 x 4	5 ½ in 140 mm
50-1194	Self-Retaining Prongs, Sharp	2 ¼ in 57 mm	3 x 4	5 ½ in 140 mm
50-5646	Self-Retaining Prongs, Sharp	2 ¼ in 57 mm	2 x 3	2 ¼ x 4 ½ in 57 x 114 mm
50-5647	Self-Retaining Prongs, Blunt	2 ¼ in 57 mm	2 x 3	2 ¼ x 4 ½ in 57 x 114 mm

Retractors (Self-Retaining)

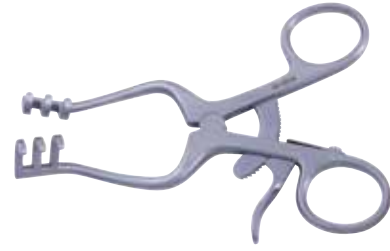

Infant Weitlaner Retractor

CODE	DESCRIPTION	PRONGS	LENGTH
61-0610	Blunt	3x3	4½ in 114 mm

Retractors (Sternal)



Ankeney Sternal Retractor

Child Size, Aluminum, with Stainless Steel Rack

CODE	ARM LENGTH	BLADE WIDTH	BLADE DEPTH	TOTAL OPENING
50-8068	4½ in 114 mm	¾ in 19 mm	1 in 25 mm	5 in 127 mm



Morse Sternal Retractor

Child Size, Self-Retaining with Rack and Pinion Action

CODE	ARM LENGTH	BLADE WIDTH	BLADE DEPTH	TOTAL OPENING
50-8066	6⅛ in 156 mm	¾ in 19 mm	¾ in 19 mm	6¼ in 159 mm

Rib Spreaders (Sternal)

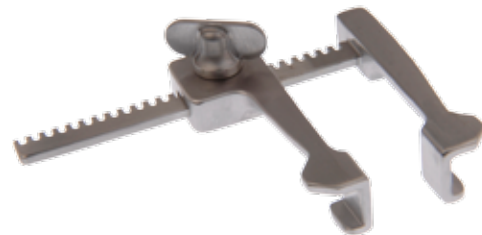

Premie Rib Spreader

CODE	ARM LENGTH	BLADE WIDTH	BLADE LENGTH	SPREAD
54-1000	1 in 25 mm	¼ in 6.0 mm	¼ in 6.0 mm	1⅞ in 40 mm

Rongeurs (Intervertebral Disc)

Schlesinger Cervical Laminectomy Rongeur

CODE	DESCRIPTION	BITE	LENGTH
53-1382	Down Biting Shaft	3.0 mm	6 in 152 mm
53-1380	Up Biting Shaft	3.0 mm	6 in 152 mm
53-1381	Up Biting Shaft	5.0 mm	6 in 152 mm



53-1380

Cushing Intervertebral Disc Rongeur

Cup Shaped Jaws

CODE	DESCRIPTION	CUP	LENGTH
53-1290	Straight	2.0 x 10 mm	5 in 127 mm
53-1291	Curved Up	2.0 x 10 mm	5 in 127 mm



53-1290

Hoen Intervertebral Disc Rongeur

CODE	DESCRIPTION	CUP	LENGTH
53-1224	Fenestrated Jaws	4.0 x 12 mm	5½ in 140 mm



Tip

Peapod Intervertebral Disc Rongeur

CODE	DESCRIPTION	CUP	LENGTH
53-1255	Curved Up	2.0 x 6.0 mm	5½ in 140 mm



Selverstone Intervertebral Disc Rongeur

CODE	DESCRIPTION	CUP	LENGTH
53-1325	Straight	2.0 x 3.0 mm	6 in 152 mm
53-1326	Straight	2.0 x 5.0 mm	6 in 152 mm



53-1325

Rongeurs (Intervertebral Disc)

Spurling Intervertebral Disc Rongeur

CODE	DESCRIPTION	CUP	LENGTH
53-1300	Straight	4.0 x 10 mm	6 in 152 mm



Wilde Intervertebral Disc Rongeur

CODE	DESCRIPTION	CUP	LENGTH
53-1280	Straight #1	5.0 x 15 mm	5½ in 140 mm
53-1281	Straight #2	5.2 x 15 mm	5½ in 140 mm



53-1280



Tip

Rongeurs (Laminectomy)

Kerrison Laminectomy Rongeur

CODE	DESCRIPTION	BITE	LENGTH
53-1374	Down Biting Shaft	3.0 mm	6 in 152 mm
53-1375	Down Biting Shaft	5.0 mm	6 in 152 mm
53-1370	Up Biting Shaft	3.0 mm	6 in 152 mm
53-1371	Up Biting Shaft	5.0 mm	6 in 152 mm



53-1370

Scissors (Corneal)

Castroviejo Corneal Scissors

CODE	DESCRIPTION	LENGTH
54-6571	Curved Tip	4¼ in 108 mm



Scissors (Delicate)

Delicate Scissors

CODE	DESCRIPTION	LENGTH
54-2515	Straight, Blunt	4½ in 114 mm
54-5567	Curved with Dissecting End	4⅞ in 124 mm
54-5571	Curved, Delicate	5¾ in 146 mm



Scissors (Dissecting)

Delicate Dissecting Scissors

CODE	DESCRIPTION	LENGTH
54-5566	Curved	5 in 127 mm



Mayo Classic Plus Dissecting Scissors

Stellite Edge Inserts

CODE	DESCRIPTION	LENGTH
36-5050	Straight	5½ in 140 mm
36-5060	Curved	5½ in 140 mm



36-5050

Scissors (Dissecting)

Mayo Dissecting Scissors

Beveled Blades

CODE	DESCRIPTION	LENGTH
54-4098	Straight	5½ in 140 mm
54-4099	Curved	5½ in 140 mm



54-4098

Metzenbaum Classic Plus Dissecting Scissors

Delicate Stellite Edge Inserts

CODE	DESCRIPTION	LENGTH
36-5030	Curved, Sharp/Sharp	5¾ in 146 mm
36-5031	Curved, Blunt/Blunt	5¾ in 146 mm



36-5031

Metzenbaum Dissecting Scissors

CODE	DESCRIPTION	LENGTH
54-1023	Curved	5 in 127 mm



Scissors (Dural)

Taylor Dural Scissors

CODE	DESCRIPTION	LENGTH
54-1050	Scissors	5¾ in 146 mm



Scissors (Fine)

Fine Scissors

CODE	DESCRIPTION	LENGTH
54-1075	Straight, Sharp/Sharp	4½ in 114 mm
54-1076	Curved, Sharp/Sharp	4½ in 114 mm



54-1075

Scissors (Iris)

Iris Classic Plus Scissors

CODE	DESCRIPTION	LENGTH
34-6500	Straight, Sharp/Sharp	4¾ in 111 mm
34-6503	Curved, Sharp/Sharp	4¾ in 111 mm



34-6500

Iris Classic Scissors

Stellite Edge Inserts

CODE	DESCRIPTION	LENGTH
36-5000	Straight, Sharp/Sharp	4½ in 114 mm
36-5001	Curved, Sharp/Sharp	4½ in 114 mm



36-5000

Iris Scissors

CODE	DESCRIPTION	LENGTH
54-6500	Straight, Sharp/Sharp	4¾ in 111 mm
54-6503	Curved, Sharp/Sharp	4¾ in 111 mm



54-6503

Scissors (Iris)

Knapp Iris Scissors

CODE	DESCRIPTION	LENGTH
54-6524	Straight, Sharp/Blunt	4 in 102 mm
54-6526	Straight, Blunt, Blunt	4 in 102 mm
54-6525	Curved, Sharp/Blunt	4 in 102 mm
54-6527	Curved, Blunt, Blunt	4 in 102 mm



Scissors (Micro)

Micro Scissors

CODE	DESCRIPTION	LENGTH
80-2005	Straight Tip	5½ in 140 mm
80-2006	Curved Tip	5½ in 140 mm

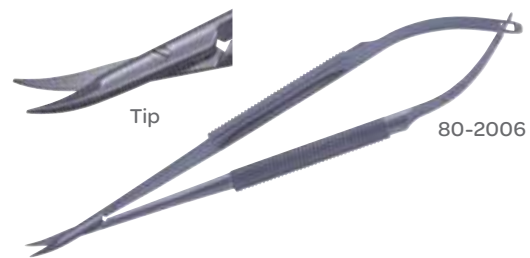

Scissors (Microsurgical)

Decker Microsurgical Scissors

Alligator Action

CODE	DESCRIPTION	BLADELENGTH	LENGTH
54-5604	Straight	5.0 mm	5½ in 140 mm
54-5605	Curved Left	5.0 mm	5½ in 140 mm
54-5606	Curved Right	5.0 mm	5½ in 140 mm

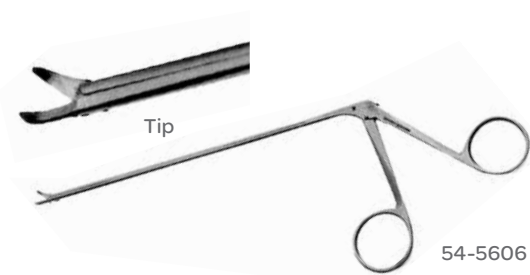

E-Series Scissors

Titanium, Serrated Jaws

CODE	DESCRIPTION	LENGTH
80-6008	Straight, Fine Tip	6 in 152 mm
80-6009	Straight, Regular Tip	6 in 152 mm



Scissors (Operating)

Classic Mayo Scissors

CODE	DESCRIPTION	LENGTH
34-4098	Straight, Beveled Blades	5 ½ in 140 mm



Deaver Operating Scissors

CODE	DESCRIPTION	LENGTH
54-4066	Straight, Sharp/Blunt	5 ½ in 140 mm



Operating Classic Plus Scissors

Stellite Edge Inserts

CODE	DESCRIPTION	LENGTH
36-5040	Straight, Sharp/Blunt	5 ½ in 140 mm



Scissors (Operating)

Operating Scissors

CODE	DESCRIPTION	LENGTH	
54-4026	Straight, Sharp/Blunt	5 in	127 mm
54-4027	Straight, Sharp/Sharp	5 in	127 mm
54-4028	Straight, Blunt/Blunt	5 ½ in	140 mm
54-4029	Straight, Sharp/Blunt	5 ½ in	140 mm
54-4030	Straight, Sharp/Sharp	5 ½ in	140 mm
54-4032	Straight, Sharp/Blunt	6 in	153 mm
54-4300	Straight, Sharp/Blunt, Delicate	5 in	127 mm
54-4301	Straight, Sharp/Sharp, Delicate	5 in	127 mm
54-4306	Straight, Sharp/Blunt, Delicate	5 ½ in	140 mm



Scissors (Pituitary)

Sweet Pituitary Scissors

CODE	DESCRIPTION	BLADE LENGTH	LENGTH
54-1091	Straight, Alligator Blades	¾ in 10 mm	5 ½ in 140 mm



Scissors (Sinus)

Sinus Scissors

CODE	DESCRIPTION	BLADES	LENGTH
63-7700	Straight, Pediatric	5.0 mm	5 ¾ in 146 mm
63-7701	Left, Pediatric	5.0 mm	5 ¾ in 146 mm
63-7702	Right, Pediatric	5.0 mm	5 ¾ in 146 mm



Scissors (Stitch)

Littauer Stitch Scissors

CODE	DESCRIPTION	LENGTH
54-4017	Scissors	5½in 140mm



Shortbent Stitch Scissors

CODE	DESCRIPTION	LENGTH
54-2555	Curved on Side	3½in 89mm



Spencer Stitch Scissors

CODE	DESCRIPTION	LENGTH
54-6624	Scissors	3½in 89mm
54-4205	Scissors	4½in 114mm



54-6624

Wescott Stitch Scissors

CODE	DESCRIPTION	LENGTH
54-6630	Sharp/Sharp	4¼in 108mm



Scissors (Strabismus)

Classic Strabismus Scissors

CODE	DESCRIPTION	LENGTH
34-6517	Curved, Blunt/Blunt	4½ in 114 mm



Strabismus Classic Plus Scissors

Stellite Edge Inserts

CODE	DESCRIPTION	LENGTH
36-5005	Straight, Blunt/Blunt	4½ in 114 mm



Strabismus Scissors

CODE	DESCRIPTION	LENGTH
54-6515	Straight, Blunt/Blunt	4½ in 114 mm
54-6517	Curved, Blunt/Blunt	4½ in 114 mm



54-6517

Scissors (Tenotomy)

Jamison Metzenbaum Tenotomy Scissors

CODE	DESCRIPTION	LENGTH
37-4033	Curved	6 in 152 mm

Image Not Available



Scissors (Tenotomy)

Stevens Tenotomy Scissors

CODE	DESCRIPTION	LENGTH
54-6520	Straight	4 $\frac{1}{8}$ in 105 mm
54-6522	Straight	4 $\frac{5}{8}$ in 118 mm
54-6521	Curved	4 $\frac{1}{8}$ in 105 mm
54-6523	Curved	4 $\frac{5}{8}$ in 118 mm



54-6520

Wescott Tenotomy Scissors

CODE	DESCRIPTION	LENGTH
54-6513	Blunt/Blunt	4 $\frac{1}{4}$ in 108 mm



Mattox-Potts Scissors

CODE	ANGLE	BLADE LENGTH	TOTAL LENGTH
54-8004	45°	$\frac{13}{16}$ in 21 mm	5 $\frac{1}{2}$ in 140 mm



Scissors (Vascular)

Vascular Scissors

CODE	ANGLE	BLADE WIDTH	BLADE LENGTH	LENGTH
54-8008	45°	$\frac{3}{16}$ in 5.0 mm	$\frac{1}{2}$ in 13 mm	5 $\frac{1}{4}$ in 130 mm



Scissors (Wire Suture)

Wire Cutting Suture Scissors

CODE	DESCRIPTION	LENGTH
54-4210	Serrated Blades	4½ in 114 mm



Wire Suture Scissors

CODE	DESCRIPTION	LENGTH
54-4110	Angled, One Serrated Jaw	4¾ in 121 mm



Sounds (Infant Urethral)



51-6808

McCrea Infant Urethral Sound

CODE	DESCRIPTION	LENGTH
51-6808	8 French, Curved, Plain Tip	7 in 17.5 cm
51-6810	10 French, Curved, Plain Tip	7 in 17.5 cm

Speculum (Eye)



Barraquer Eye Specula

CODE	DESCRIPTION
60-1962	Pediatric, 5.0 mm Wide

Suction Tubes (Dural)



Dural Suction Retractor

CODE	DESCRIPTION	TIP WIDTH	TIP DEPTH	WORKING DISTANCE	HANDLE LENGTH
46-3013	Standard Macro, Black	$\frac{3}{8}$ in 10 mm	$\frac{1}{4}$ in 6.0 mm	4 $\frac{3}{4}$ in 120 mm	4 $\frac{1}{2}$ in 114 mm

Suction Tubes (Pediatric)



Pediatric Suction Tube

CODE	DESCRIPTION
09-8520	#1, Fixed Tip, Fluted

Suction Tubes (Pediatric)

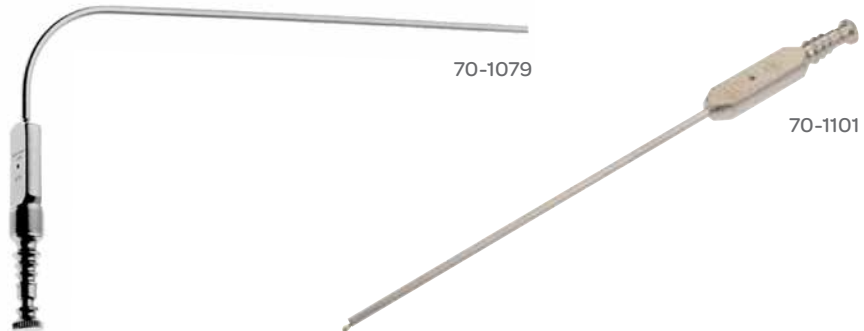

Frazier Suction Tube

CODE	DESCRIPTION	DIAMETER	LENGTH
70-1101	Straight	9 French with Thumb Control	5¼ in 133 mm
70-1102	Straight	11 French with Thumb Control	5¼ in 133 mm
70-1079	Angular	7 French with Thumb Control	4½ in 114 mm
70-1005	Angular	7 French with Thumb Control, Insulated	4½ in 114 mm
70-1087	Angular	7 French with Thumb Control	7½ in 191 mm
70-1080	Angular	9 French with Thumb Control	4½ in 114 mm
70-1081	Angular	11 French with Thumb Control	4½ in 114 mm
70-1089	Angular	11 French with Thumb Control	7½ in 191 mm
70-1017	Angular	11 French with Thumb Control, Insulated	7½ in 191 mm

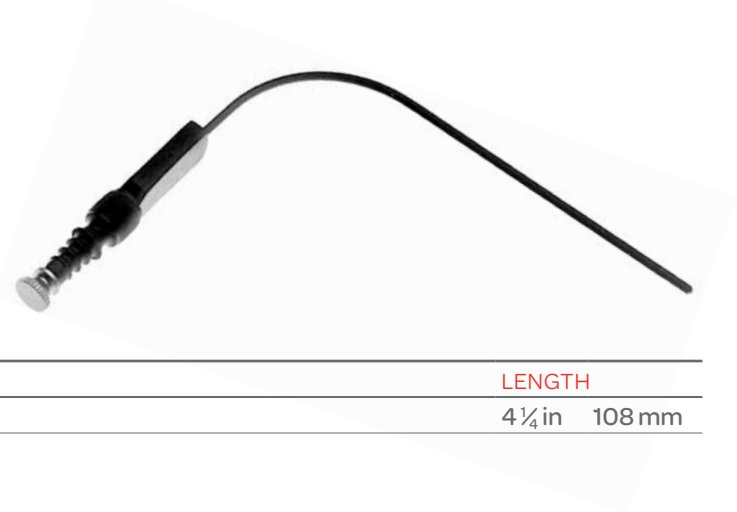

Malis Frazier Suction Tube

CODE	DESCRIPTION	LENGTH
70-1103	7 French, Black Anodized	4¼ in 108 mm

Pribram Suction Tube

70-1128

CODE	DESCRIPTION	LENGTH
70-1128	16 Gauge with Thumb Control	5½ in 140 mm
70-1130	18 Gauge with Thumb Control	5½ in 140 mm

Tissue Forceps (Dressing)

Bishop Harman Dressing Forceps

CODE	TIP WIDTH	LENGTH
30-6557	0.4 mm	3 ³ / ₈ in 86 mm

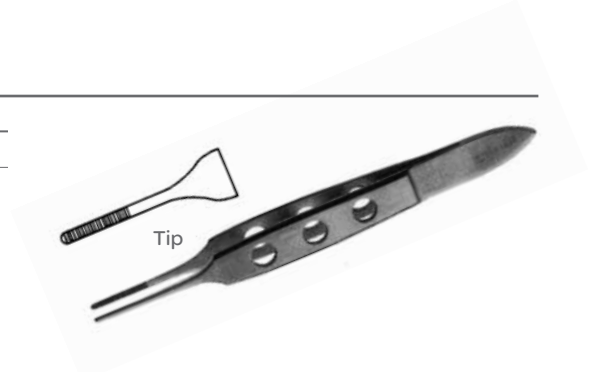

Tissue Forceps (Fixation)

Von Graefe Fixation Forceps

CODE	DESCRIPTION	TIP WIDTH	LENGTH
30-6585	Without Teeth	2.0 mm	4 ³ / ₄ in 121 mm



Tissue Forceps (Iris)

Bishop Harmon Iris Forceps

CODE	DESCRIPTION	TEETH	TIP WIDTH	LENGTH
30-6555	Standard	1x2	0.5 mm	3 ¹ / ₄ in 83 mm
30-6556	Delicate	1x2	0.3 mm	3 ¹ / ₄ in 83 mm



Tissue Forceps (Micro)

E-Series Forceps

CODE	DESCRIPTION	TIP WIDTH	LENGTH
80-6630	Straight, Extra Fine	0.7 mm	6 in 152 mm



Tissue Forceps (Tissue)

Adson Tissue Forceps

CODE	DESCRIPTION	TIP WIDTH	LENGTH
30-4218	1x2 Teeth, Delicate	0.7 mm	5 in 127 mm
30-1186	1x2 Teeth	1.2 mm	5 in 127 mm
30-1187	2x3 Teeth	1.8 mm	5 in 127 mm
30-1188	2x3 Teeth	3.0 mm	7 in 178 mm

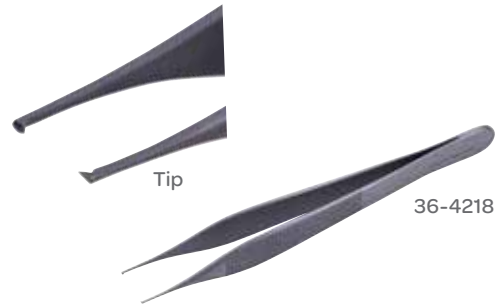

Adson Tissue Forceps

Tungsten Carbide Tip

CODE	DESCRIPTION	TIP WIDTH	LENGTH
36-6000	Serrated Jaws	2.0 mm	4 3/4 in 121 mm



Adson Tissue Forceps

CODE	DESCRIPTION	TIP WIDTH	LENGTH
65-2413	Non-Magnetic, Titanium		5 in 127 mm



Adson-Brown Tissue Forceps

CODE	TIP WIDTH	LENGTH
30-1189	1.7 mm	5 in 127 mm



Tissue Forceps (Tissue)

Allis Classic Tissue Forceps

Standard Line

CODE	TEETH	LENGTH
32-7000	4 x 5	6 in 152 mm
32-7001	5 x 6	6 in 152 mm

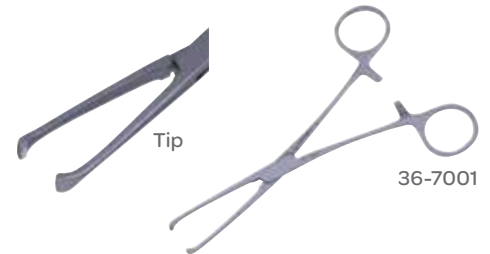

Ewald-Hudson Tissue Forceps

CODE	DESCRIPTION	TIP WIDTH	LENGTH
30-4216	1 x 2 Teeth	1.6 mm	5 in 127 mm



Iris Tissue Forceps

CODE	DESCRIPTION	TEETH	TIP WIDTH	LENGTH
30-6532	Curved	1 x 2	0.5 mm	4 in 102 mm



Jewelers Forceps

CODE	DESCRIPTION	LENGTH
30-6712	#3	4 3/4 in 121 mm
30-6713	#3C	4 5/16 in 109 mm
30-6714	#4	4 1/4 in 108 mm
30-6715	#5	4 5/16 in 109 mm



Tissue Forceps (Tissue)

Russian Tissue Forceps

CODE	TIP WIDTH	LENGTH
30-4220	6.0 mm	6 in 152 mm



Semkin Tissue Forceps

CODE	TIP WIDTH	LENGTH
30-1170	1.3 mm	5 in 127 mm



Tickner Forceps

CODE	DESCRIPTION	TIP WIDTH	LENGTH
36-6030	Tungsten Carbide Inserts	1.8 mm	6 in 152 mm



Tissue Forceps

CODE	DESCRIPTION	TIP WIDTH	LENGTH
30-4151	1x2 Teeth	2.3 mm	5 in 127 mm
30-4152	1x2 Teeth	2.3 mm	5½ in 140 mm
30-4153	1x2 Teeth	2.3 mm	6 in 152 mm
30-4161	2x3 Teeth	3.9 mm	5½ in 140 mm

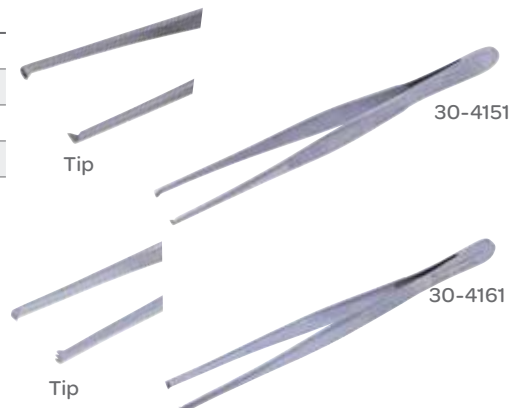

Tissue Forceps (Tissue)

Tissue Forceps

Non-Magnetic Titanium

CODE	DESCRIPTION	TIP WIDTH	LENGTH
65-2420	1 x 2 teeth	2.3 mm	5½ in 140 mm



Tissue Forceps (Utility)

Nugent Utility Forceps

CODE	DESCRIPTION	TIP WIDTH	LENGTH
30-6695	Smooth Jaw, Angled Tip	0.5 mm	4 in 102 mm



Tissue Forceps (Vascular)

Castaneda Forceps

Grooved with Cross Serrations

CODE	TEETH	TIP WIDTH	LENGTH
30-8500	1 x 2 Vascular	1.7 mm	6 in 152 mm



Tourniquets (Obturator)

Rumel Obturator

CODE	DESCRIPTION	LENGTH
67-8004	Child, Obturator Only	6 in 152 mm

Image Not Available

